

DATA TRANSFER STANDARD EVA DTS 6.1.2

In cooperation with



Copyright by the European Vending Association

All rights reserved

No part of this publication may be reproduced or transmitted, in any form or by any means, electronic, mechanical, photocopying, recording or otherwise, or stored in any retrieval system of any nature, without the written permission of EVA.





Table of Contents

CHAPTER 1 - INTRODUCTION TO EVA-DTS VERSION 6.1.2.....	7
INTRODUCTION	7
1.1 AIM OF THE STANDARD.....	8
1.2 GLOSSARY OF TERMS USED IN THE STANDARD.....	10
1.3 EVOLUTION OF THE STANDARD	11
1.3.1 Migration to newer technologies	13
1.4 APPLICATION OF THE STANDARD	14
CHAPTER 2 - DATA FORMAT AND PRESENTATION.....	16
2.1 REPORT	16
2.1.1 Definition of a Report.....	16
2.1.2 Syntax of a Report	17
2.2 DATA SEGMENTS	17
2.2.1 Definition of A Data Segment.....	17
2.2.2 Syntax of A Data Segment.....	18
2.2.3 Examples of Actual Data Segments.....	19
2.3 DATA ELEMENTS	20
2.3.1 Definition of a Data Element	20
2.3.2 Data Element Format	20
2.4 MANDATORY HEADERS AND TRAILERS.....	23
2.4.1 Application Header and Trailer (DXS and DXE)	23
2.4.2 Transaction Set Header and Trailer	24
2.4.3 Data Record Integrity Check	25
2.4.4 Example Report.....	27
2.5 RECOMMENDED AUDIT REPORT	28
2.6 RESETTING INTERVAL DATA ELEMENTS	42
2.6.1 Interval Data Elements (All).....	42
2.6.2 Interval Data Elements (Selective)	43
2.7 DATA REPORTING	44
2.7.1 Selective Reporting of Data	44
2.7.2 Reporting of Data using lists	45





2.8 EVENT REPORTING INSTRUCTIONS	45
2.8.1 Event Inclusion	46
2.8.2 Event Resetting / Clearing	46
2.8.3 Event Reporting Examples	47
CHAPTER 3 - DATA TRANSFER USING ENHANCED DDCMP	51
3.1 SCOPE	51
3.1.1 Terms	52
3.2 INTERFACE OVERVIEW	53
3.2.1 General Data Transfer Operation	57
3.3 PHYSICAL LEVEL DETAILS	57
3.4 DATALINK LEVEL	58
3.4.1 Data Format	59
3.4.2 Basic Transmission Parameters	60
3.4.3 Message Framing	62
3.4.4 Data Length Restrictions	63
3.4.5 Cyclic Redundancy Check	64
3.4.6 Datalink Timings/Restrictions	65
3.5 SESSION LEVEL	66
3.5.1 Initialization & Maintenance	66
3.5.2 Error Handling	68
3.6 APPLICATION LEVEL DETAILS	71
3.6.1 Message Types	71
3.6.2 Control Messages	75
3.6.3 Data Message Header	81
3.6.4 Data Messages	83
3.6.5 Message Sequence	96
3.7 COMMUNICATIONS SESSION	97
3.7.1 Initialize Link	98
3.7.2 Data Message Transfer	98
3.7.3 Turn Around Time	103
CHAPTER 4 - DATA TRANSFER USING DEX/UCS	104
4.1 SCOPE	104
4.2 INTERFACE OVERVIEW	105
4.3 PHYSICAL LEVEL DETAILS	106





4.4 DATA LINK LEVEL DETAILS	106
4.5 SESSION LEVEL DETAILS	108
4.5.1 Vending Machine Session Establishment.....	109
4.5.2 Business System Computer Session Establishment	110
4.5.3 Session Establishment Formats	110
4.5.4 Communication IDs	114
4.5.5 Operation Request.....	114
4.5.6 Revision & Level	115
4.5.7 Response Codes	115
4.5.8 Timers and Limits	116
4.6 SESSION / APPLICATION LEVEL DATA TRANSFER	117
4.6.1 Data Transfer Formats	118
4.6.2 Overall Data Format	120
4.7 DEX DATA TRANSFER EXAMPLES	120
4.8 APPLICABLE DEX/UCS DOCUMENTATION.....	123
CHAPTER 5 - APPLICATION NOTES - DATA.....	124
5.1. APPLICATION NOTES FOR THE DATA.....	124
5.1.1 Data Element Configuration	124
5.1.2 Manual Data Entry	126
5.1.3 Repeating Data Groups	126
5.1.4 Selective reporting and selective resetting of data elements	129
5.1.5 Element Length	132
5.1.6 Data Element Format (Type).....	133
5.1.7 Price Lists.....	133
5.1.8 Mixed Payment Reporting	135
5.1.9 Difference between "zero price vends" and "free vends"	136
5.1.10 Product Level related elements.....	137
5.2. EXAMPLES OF UPDATING DTS DATA FIELDS.....	137
5.2.1 Continuous update.....	138
5.2.2 Value Token reporting	138
5.2.3 Vend Examples	138
5.2.4 Cash Examples.....	167
5.3. APPLICATION NOTES FOR GENERAL ACCEPTED ACCOUNTING PRINCIPLES (GAAP).....	172
5.3.1 Forward	172
5.3.2 Source of Data	172
5.3.3 Transfer of Data	173
5.3.4 Transactional view	173
5.3.5 Securing the archive.....	174





5.3.6 Overcoming the technical limits.....	175
5.3.7 Fault conditions.....	176
5.3.8 Conclusive.....	176
CHAPTER 6 - APPLICATION NOTES - DDCMP.....	177
6.1 APPLICATION NOTES FOR THE ENHANCED DDCMP.....	177
6.1.1 Byte Format (see 3.4.1.2 and 3.6.4.1.1)	177
6.1.2 Cyclic Redundancy Check (see 3.4.5).....	178
6.1.3 Enhanced DDCMP Features	181
6.1.4 Command Messages & Responses	182
6.1.5 Message Sequences - End of Communications Sequence	183
6.1.6 Security-Passcode usage	184
6.1.7 Configuration features.....	185
6.1.8 Slave address setting.....	185
6.2 EXAMPLE COMMUNICATION SEQUENCES.....	185
6.2.1 Standard Data Collection Examples.....	186
6.2.2 Error Handling Sequences.....	195
CHAPTER 7 - DATA TRANSFER PHYSICAL LAYERS.....	201
7.1 SCOPE	201
7.2 OVERVIEW	201
7.3 HARDWIRED PHYSICAL LEVEL DETAILS	202
7.3.1 Vending Machine Device (VMD)	202
7.3.2 Data Carrier (DC)	203
7.3.3 Business System Computer (BSC)	203
7.4 OPTICAL IRDA PHYSICAL LEVEL DETAILS.....	204
7.4.1 Optical Characteristics.....	204
7.4.2 Receiver Characteristics	206
7.4.3 Physical Separation of Optics	206
APPENDIX A - DATA DICTIONARY	208
A.1 DEFINITIONS	208
APPENDIX B - MANUFACTURER CODES	273
APPENDIX C - EVENT LIST	282
C.1 INTRODUCTION	282





C.2 EVENT LISTS	282
C.2.1 Equipment Event Codes	283
C.2.2 Operational Event Codes	284
C.2.3 Specific Event Codes.....	285
C.2.4 Example Code.....	285
C.2.5 Manufacturer Specific or New Codes	285
C.2.6 Additional Event Information	286
Table 1: COIN MECHANISM.....	287
Table 2: CUP SYSTEM.....	289
Table 3: CONTROL SYSTEM.....	291
Table 4: HOT DRINKS SYSTEM	292
Table 5: BREWER/ESPRESSO UNIT	294
Table 6: WATER SYSTEM	295
Table 7: CABINET/DOOR	296
Table 8: COLD DRINK DISPENSING SYSTEM	297
Table 9: COMMUNICATIONS.....	299
Table 10: FOOD, SNACK, OR CAN/BOTTLE SYSTEM.....	301
Table 11: CASHLESS 1 SYSTEM.....	303
TABLE 11a : CASHLESS 2 SYSTEM	304
Table 12: PRODUCT	305
Table 13: MICROWAVE	306
Table 14: BILL VALIDATOR	307
Table 15: REFRIGERATION SYSTEM	308
Table 16: OPERATIONS REQUEST	309
Table 17: SERVICE RELATED.....	311
Table 18: CUSTOMER INDUCED.....	313
Table 19: RETURN VISITS.....	314
Table 20: MACHINE HISTORY	314
Table 21: CASH COLLECTION	315
C.3 PROCESS FOR MAINTAINING EVENT LIST	316
APPENDIX D - CHANGES	317
D.1. EXPLANATION OF VERSION 6.1.2.....	317
D.2. APPLICATION NOTES DATA	317
APPENDIX E - CHANGE PROCEDURE	318



CHAPTER 1 - INTRODUCTION TO EVA-DTS VERSION 6.1.2

Introduction

Forward to EVA-DTS Version 6.1.2

Version 6.1.2 of the EVA-DTS replaces Version 6.1.1 as the current version of EVA-DTS.

The fundamental protocols of the EVA-DTS standard have been preserved but additional information and explanation has been provided to aid implementation and remove ambiguity.

Appendix D outlines the significant changes to the standard in this Version.

This voluntary standard contains basic requirements for vending machines within the limitations given below. These requirements are based on sound engineering principles, research, field experience and an appreciation of the problems of manufacture, installation and use derived from consultation with and information obtained from manufacturers, users, regulatory agencies and others having specialized experience. These requirements are subject to revision as further experience and investigation may show it necessary or desirable.

EVA, in performing its functions in accordance with its objectives, does not assume or under-take to discharge any responsibility of the manufacturer or any other party. The opinions and findings of EVA represent its professional judgment given with due consideration to the necessary limitations of practical operation and state of the art at the time the Standard is processed. EVA shall not be responsible to anyone for use or reliance upon this Standard by anyone. EVA shall not incur any obligation or liability for damages, including consequential damages, arising out of or in connection with the use, interpretation of, or reliance upon this Standard.





1.1 AIM OF THE STANDARD

The aim of EVA-DTS is provide a standard format for data which is required by operators of vending machines. The standard defines the structure of common data elements and describes the means for the transfer of data

The abbreviation means European Vending Association Data Transfer Standard.

The Standard is based on the concept that data of different types are required to be entered into vending machines to enable the machine to deliver the service required.

Additionally sales and event data accumulated and stored in the machine are required to be accessed by Vending Machine Operators and transferred to management systems for either commercial or technical control purposes.

The transfer of EVA-DTS data is intended to be made by electronic means rather than printing reports which have to be processed manually. The original method for the transfer of the data which is described in this document is a portable "Data Carrier". The elements in the path of data transfer are

- **Vending Machine Device (VMD)**– This element is either a vending machine or some other device such as a payment system or data collection device. This element will require some form of data input for setting operating parameters. Also during the execution of its specific function, transaction data will be accumulated and stored which may be of use in the management of the vending service.
- **Data Carrier** – this a device, the form of which is not defined, whose role is to receive, store and transmit data to other elements in a total system. Initially the data carrier was conceived to be a handheld device, but may be a device for collecting data and transmitting data remotely. E.g telemetry
- **Business System Computer** - A computer which might receive data obtained from individual vending machines (or other Sources) and manipulate the data to provide the vending operator with management information to control the operation. It might be that the computer systems employed by the business generate some parameters which need to be transferred to the Vending machines (or other Sources). The data carrier would be the means of achieving the data flow.



The initial model for the transfer of data via a data carrier can be represented by the diagram in Figure 1.

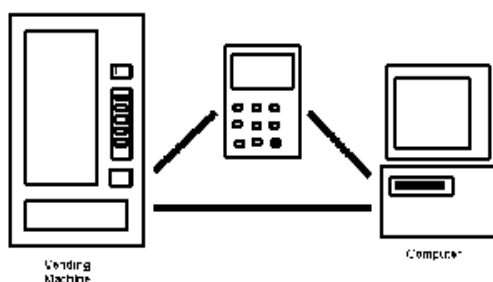

Figure 1: Potential Data Flow between System Elements

Figure 1: Potential Data Flow between System Elements

The standard specifies the form of the data elements and the protocol for transfer to and from a vending machine (or other source) and a business system. In preparing EVA-DTS Version 6.2, recognition has been taken of alternative methods of transferring data (e.g. remotely via some wireless means). The intent is not to limit the design flexibility of manufacturers of vending machines, payment systems, data carriers, business systems or other technologies for transferring data. The aim is to provide the basis for compatibility between the elements. The standard does not define how the data should be applied specify the data processing systems define report formats.

The emphasis is on creating a standardized data flow. The Standard specifies the following key features

- the structure and content of specific data fields
- specification of chosen mediums for the transfer of data
- application notes to assist in the implementation





1.2 GLOSSARY OF TERMS USED IN THE STANDARD

A number of terms and abbreviations are used throughout the standard and the principal terms are defined below:

TERM	DEFINITION
ANSI	American National Standards Institute
ASCII	American Standard Code for Information Interchange
Audit Element	A single element within an audit report e.g. ID101 (machine serial number)
Audit Element Delimiter	a single asterix character used to separate audit elements in an audit report
Audit Group	a term used to describe a collection of audit elements e.g. ID
Audit Report	An entire collection of audit information from a data source
BDV	Bundesverband Deutscher Verpflegungs- und Vending-Unternehmen e.V. (German Vending Association).
Business System Computer	Typically the back office computer system
CRC	cyclic redundancy check
Data Carrier	A handheld computing device used to collect and transport audit information
Data Source or Data Sink	Device that accumulates audit information and passes it into a data carrier or receives data from a data carrier
DDCMP	DEC Data Communication Message Protocol
DEX	Direct Exchange
DTS	Data Transfer Standard, i.e. this document.
Enhanced DDCMP	is data transmission solution based on IrDA electronic hardware.
EOP	Enhanced Optical Protocol. This term is no longer in use and has been replaced by Enhanced DDCMP
EVA	European Vending Association
IrDA	Infra red Data Association
NAMA	National Automatic Merchandising Association
UCC	Uniform Code Council
UCS	Uniform Communications Standard
VIDTS	Vending Industry Data Transfer Standard, old name for EVA-DTS
VMD	Device in vending machine that monitors the various transactions and assimilates the audit data.
VMC	Vending Machine Control Board





1.3 EVOLUTION OF THE STANDARD

The standard has evolved over several years. Originally a standard was developed and published by the German Vending Association, the BDV. The work was undertaken at the same time as the American Association, NAMA, was also seeking to develop a standard for data transfer. The definitions of the data elements were mutually agreed. Different physical means for the connection between system elements and the protocol for the transmission of data were chosen.

Typically, US manufacturers and operators have chosen a data transmission solution based on the DEX/UCS data exchange protocol and a physical connection through a ¼ inch jack plug. However, it may be in the future that developers may wish to use the DEX/UCS data exchange protocol via the IrDA infra red physical layer.

European applications have been specified to use the Enhanced DDCMP protocol and an optical interface. It is also possible to implement the Enhanced DDCMP Protocol with ¼ inch jack plug physical link.

The original BDV document for DDCMP was called BDV002, but the VIDTS was a complete rewrite of the entire way of doing auditing. Based on the Uniform Code Council (UCC) DEX/ UCS standard, the vending industry adopted this data format as a means of transferring information between devices. The US adopted the ANSI x3.28 transport layer and physical 1/4" hardwired interface as specified by the existing DEX/UCS standard from the UCC.

Note: The earlier versions of the standard up to Version 4.1 described both the original DDCMP based optical interface and latterly an enhanced optical protocol, also based on DDCMP but with the higher baud rate potential of the IrDA hardware. In version 5.0. the Optical Interface (formally called EOP) was re-named Enhanced DDCMP.

Implementers of EVA-DTS in data carriers should take account of the requirement to transfer data to and from existing data sources/sinks that might have been based on the original optical link. Reference should be made to version 4.1 of the standard which is reproduced on the CD containing version 6.1.2

Version 6.1. simplified the handling of discounts and surcharges by simply using the new PA7 elements instead of PA2 and LA elements. Consequently the recommended list was shortened

The standard can be described by reference to the OSI 7-layer model.





Table 1 shows relevant layers of the standard and the elements in the DEX/UCS based and Enhanced DDCMP based solutions.

Table 1. Diagram of Layered Protocol

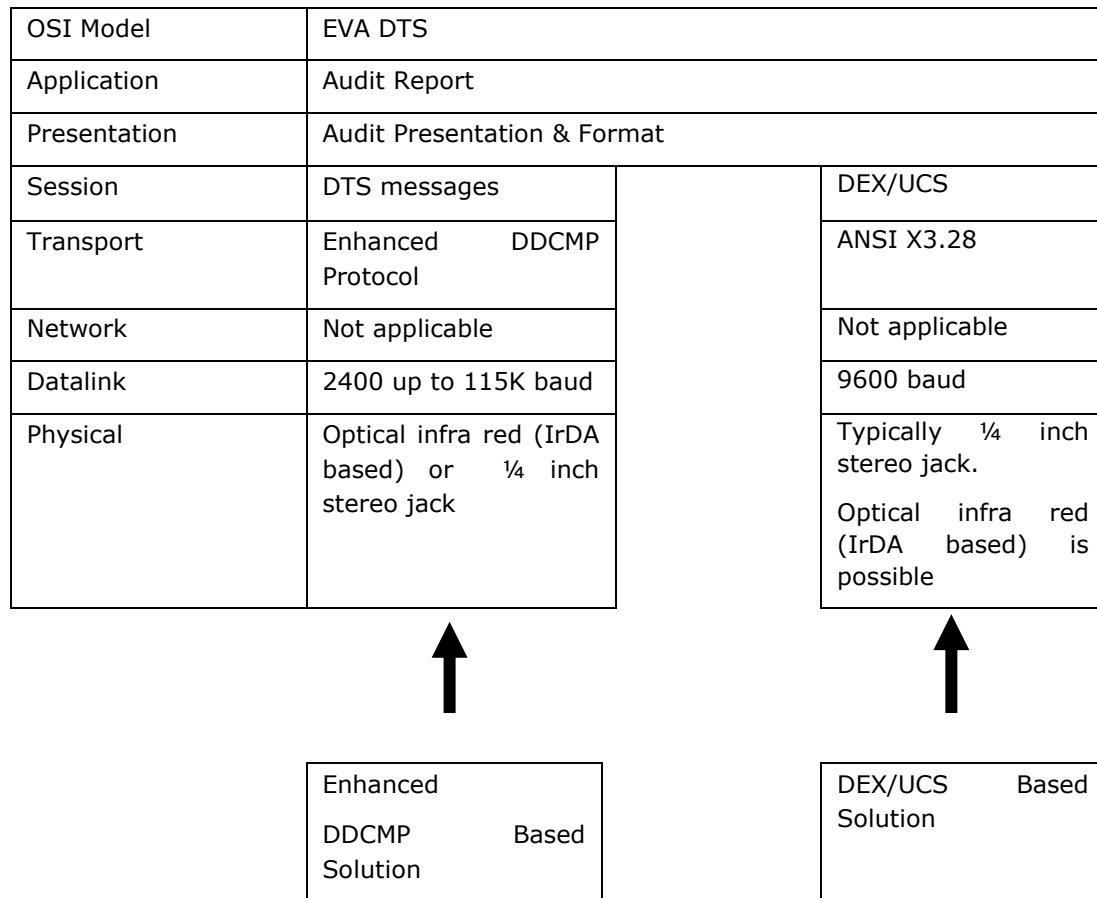



1.3.1 Migration to newer technologies

Since IRDA and Serial Ports are rarely available anymore, but the installed basis in the field will exist for many further years, new implementers could choose the following methods.

Use a hardware-converter to connect new interface technologies (like Bluetooth or USB) to existing IRDA or RS232 ports or for direct connection between new interface technologies use a virtual serial port profile.

Table 2 shows relevant layers of the standard and the elements in the DEX/UCS based and Enhanced DDCMP for newer technologies.

Table 2. Diagram of Layered Protocol for newer technologies

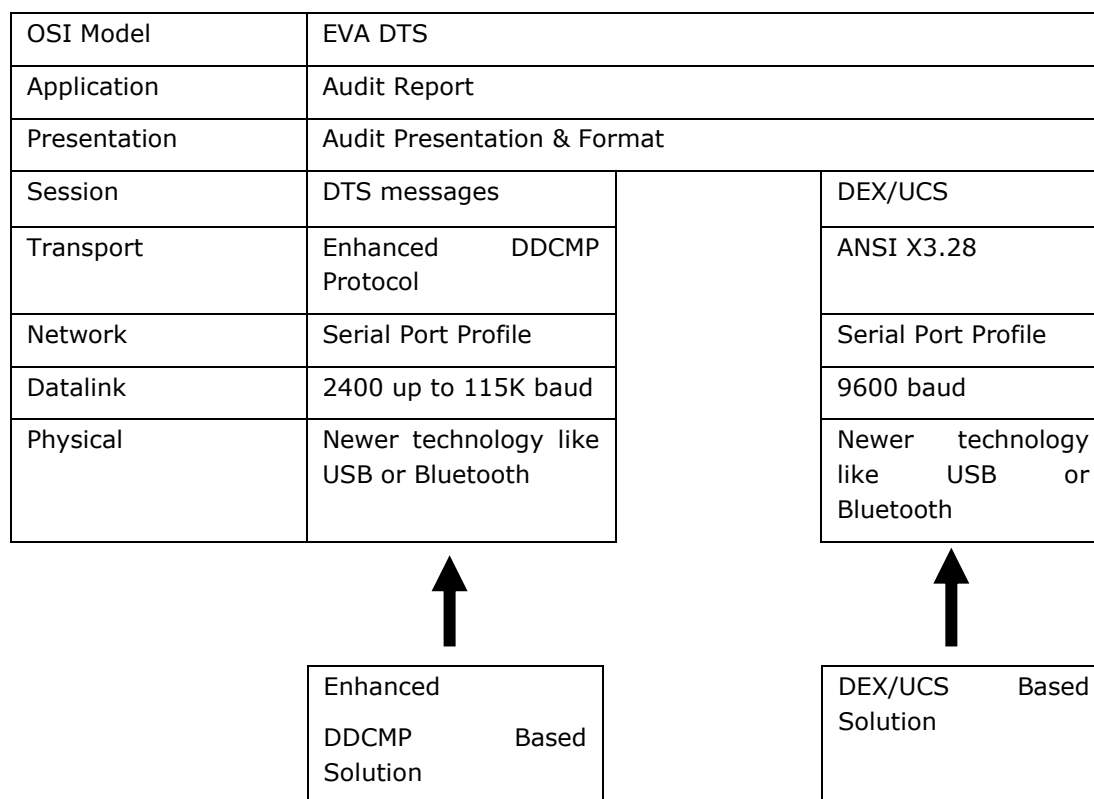



1.4 APPLICATION OF THE STANDARD

Version 6.1.2 of EVA-DTS seeks to encourage a wider application of the standard by simplifying the task of potential implementers. It is aimed to achieve this by guiding the implementers of new applications to the essential elements of the total system, which is of relevance to them.

Table 3 outlines the relevant chapters for specific applications.





Table 3.

Required Solution	Chapter 2 Data Format & Presentation	Chapter 3 Enhanced DDCMP	Chapter 4 DEX/UCS	Chapter 5 Application Notes Data	Chapter 6 Application Notes DDCMP	Chapter 7 Physical Layers	Appendices	Version 4.1
DEX/UCS protocol using ¼ " jack plug connection	x		x			x	x	
DEX/UCS protocol using Irda Infra red connection	x		x			x	x	
Enhanced DDCMP protocol with (infra-red) optical connection based on IrDa hardware	x	x		x	x	x	x	
Enhanced DDCMP protocol but with connection using ¼ " jack plug	x	x		x	x	x	x	
Original low speed DDCMP protocol with infra-red optical connection	x				x		x	x
Original low speed DDCMP protocol using ¼ " jack plug	x				x	x	x	x
Data Carrier for complete backwards compatibility	x	x	x	x		x	x	x

Note : Implementers of EVA- DTS in data carriers should take account of the requirement to transfer data to and from existing data sources/sinks that might have been based on the original optical link. Reference should be made to version 4.1 of the standard which is also available for free on the EVA website (www.vending-europe.eu)





CHAPTER 2 - DATA FORMAT AND PRESENTATION

2.1 REPORT

2.1.1 Definition of a Report

There are two types of reports:

- **Audit Report:** Information stored in a vending machine device (VMD¹) which is transferred via a data carrier to a business system computer. This information can either be transaction type data and/or event data.
- **Configuration Report:** Information which may be generated in a business system computer and transferred to a vending machine device via a data carrier. In some instances the configuration report can be generated in the data carrier itself. In either case, the configuration report typically modifies the operating parameters of the VMD. Also, the configuration report can send a command to the VMD to perform a specific function, i.e., RESET interval data or RESET an event.

Note 1 - A VMD is a device in a vending machine that monitors the various transactions and assimilates the audit data. Examples include vending machine control boards, VMC, coin mechanisms, cashless devices, audit devices, etc.





2.1.2 Syntax of a Report

The Audit and Configuration Reports are composed of a file consisting of several ASCII based data segments terminated with a CRLF (Carriage Return – Line Feed). Each data segment is composed of a similar group of individual data elements separated by an asterisk (*) delimiter. Because the data is all in ASCII, the entire report is “humanly readable”; however, the audit data is typically translated into more business/accounting type reports by the business system computer.

It should be noted that two different protocols (DEX/UCS and DDCMP) are used to transfer the reports between the vending machine device, the data carrier, and the business system computer. These protocols are defined in other chapters of the **Data Transfer Standard**. **Regardless of the protocol, the information and syntax of the report is exactly the same per below:**

<Application header>	Mandatory	(see paragraph 2.4)
<Transaction Set header>	Mandatory	(see paragraph 2.4)
<data segment 1>	As Required	
<data segment 2>	As Required	
<data segment 3>	As Required	
<...>		
<data segment n>	As Required	
<Record Integrity Check>	Mandatory	(see paragraph 2.4)
<Transaction Set trailer>	Mandatory	(see paragraph 2.4)
<Application trailer>	Mandatory	(see paragraph 2.4)

The following sections detail the “makeup” of the data segments and the mandatory headers, trailers, and record integrity check.

2.2 DATA SEGMENTS

2.2.1 Definition of A Data Segment

Data Segments are composed of a group of similar function data elements. These elements are not sent individually, but instead are combined into a single line which has a block identifier at the start of the line, delimiters between each element, and a carriage return / line feed (cr lf) at the end. The block identifier is a 3 or 4 character code which identifies the type of data elements following. The individual data elements are separated by an asterisk (*) delimiter.





2.2.2 Syntax of A Data Segment

<block identifier>*<data element 01>*<data element 02>*<data element 03>...*<data element n>cr lf

Where:

- <block identifier> defines the data group, it is comprised of two characters and one or two numbers. An example would be: **VA1 or CA10**
- The block identifier is followed by a delimiter (asterisk '*').
- <data element nn> A data element is a numeric value or an alphanumeric string.
- All characters sent within the Data Segments must be the lower, printable ASCII characters (20h to 7Eh) plus the Carriage Return (0Dh) and Line Feed (0Ah).
- If more than one element (<data element 01> to <data element nn) is included, the elements are separated by a delimiter (asterisk '*'). The position of the elements in the data segment are referred to using the block identifier and the element number. An example would be: **VA1*VA101*VA102*VA103*VA104** or **CA10*CA1001*CA1002**
- After the last data element on a line there are carriage return / line feed characters defining the end of each data segment (cr lf).
- Some data segments having the same block identifier may be repeated for different values of the data elements. The first data element following the block identifier uniquely identifies the data segment. An example would be:

PA1*PA101*PA102*PA103crlf	where PA101 = "SEL 1"
PA1*PA101*PA102*PA103crlf	where PA101 = "SEL 2"
PA1*PA101*PA102*PA103crlf	where PA101 = "SEL 3"

- Some data segments having the same block identifier may be repeated for different values of the data elements and also contain subsequent repeated data segments. The first data element following the lowest numbered block identifier uniquely identifies the data segment and its subsequent data segments. An example would be:

PA1*PA101*PA102*PA103crlf	where PA101 = "SEL 1"
PA5*PA501*PA502*PA503crlf	
PA7*PA701*PA702*PA703*PA704*PA705*PA706*PA707*PA708crlf	
PA1*PA101*PA102*PA103crlf	where PA101 = "SEL 2"
PA5*PA501*PA502*PA503crlf	
PA7*PA701*PA702*PA703*PA704*PA705*PA706*PA707*PA708crlf	
PA1*PA101*PA102*PA103crlf	where PA101 = "SEL 3"
PA5*PA501*PA502*PA503crlf	
PA7*PA701*PA702*PA703*PA704*PA705*PA706*PA707*PA708crlf	

- If data elements are not available, they can be omitted and only the asterisk delimiter needs to be sent. i.e. ** or *CRLF indicates an element is not available. An example would be:

ID1*ID101*ID102**ID106crlf**





2.2.3 Examples of Actual Data Segments

Below are examples of actual data segments using actual data elements.

Table 1.

Example Data Segments	Description
ID1*VMC123crLf	Data element ID101 (machine serial number) is VMC123
ID1*VMC123*TYPE3Scrf	Data element ID101 (machine serial number) is VMC123 Data element ID102 (machine model number) is TYPE3S
ID1*VMC123**5678crLf	Data element ID101 (machine serial number) is VMC123 Data element ID102 (machine model number) is not included Data element ID103 (machine build standard) is 5678
ID1*VMC123**5678***CAN MACHINE 45crLf	Data element ID101 (machine serial number) is VMC123 Data element ID102 (machine model number) is not included Data element ID103 (machine build standard) is 5678 Data element ID106 (machine asset number) is CAN MACHINE 45
PA1*1*25crLf PA1*2*35crLf	Repeated group where PA101 is the selection number, PA102 is the price Selection 1 has a price of 25, and selection 2 has a price of 35.
PA1*1*25crLf PA7*1*CA*0*25*109crLf PA1*2*35crLf PA7*2*CA*0*35*345crLf	Repeated group where lines containing repeated block identifiers have their data elements defined by preceding lines PA101 is the selection number, PA102 is the price, PA705 is the number of sales since initialisation Selection 1 has a price of 25 and 109 items have been vended of that type. Selection 2 has a price of 35 and 345 items have been vended of that type.





2.3 DATA ELEMENTS

2.3.1 Definition of a Data Element

A data element holds a piece of audit or configuration information and can be of various types. Each one of the data elements is defined in the Data Dictionary appendix of the *Data Transfer Standard*.

The syntax of reports is described below. Examples would be:

PA102	Product Price held in vending machine
PC102	Product Price to be set in vending machine
ID106	Machine Asset Number of vending machine
IC106	Machine Asset Number to be set in vending machine

2.3.2 Data Element Format

› 2.3.2.1 Type

Data elements consist of different types of information as listed below. The Data Dictionary identifies the type of element with a two character code.

<alphanumeric>	AN
<numeric>	N0, N1, N2, etc.
<currency>	Nc
<date>	DT
<time>	TM
<identifier>	ID
<command>	CD



Where:

- <alphanumeric> is an element that can contain only the printable characters with the exception of the asterisk (*) since it is used as data element delimiters. By using a printable character as a pre and post identifier (i.e., the symbol for a control character, ^) the alphanumeric equivalent of the HEX value should be sent for these characters.

Below are several examples:

*	(asterisk)	^2A^
CR	(carriage return)	^0D^
LF	(line feed)	^0A^
	(First Upper 128)	^80^
^	(control symbol)	^5E^

- <numeric> is an element in which the number has an implied decimal point and is identified as **NO**, **N1**, **N2**, etc. The **0**, **1**, **2**, etc. identifies the number of digits to the right of the decimal point. Note that an integer is represented as **NO**. Again, the decimal point is implied, it is not transmitted.
- <currency> is an element in which the value has an implied decimal point. It is identified as **Nc**. Unless otherwise specified, the number of digits to the right of the decimal point are defaulted to 2. This can be overridden by a value described in the ID401 data element. Again, the decimal point is implied, it is not transmitted.
- <date> is a six or eight digit numeric field of the format YYMMDD (year, year, month, month, day, day) or YYYYMMDD (year, year, year, year, month, month, day, day). It is identified as **DT**.
- <time> is a four or six digit numeric field based on the 24 hour clock of the format HHMM (hour, hour, minute, minute) or HHMMSS (hour, hour, minute, minute, second, second). It is identified as **TM**.
- <identifier> is an element specific to the Headers and Trailers for identifying unique parameters. It is identified as **ID**.
- <command> is an element that is used to instruct a VMD to perform a specific function (i.e., RESET audit data) or set a mode (i.e., SAVE audit data). It is identified as **CD**.

› 2.3.2.2 Length

The Data Dictionary also provides information as to the minimum and maximum length of characters within an element. These are listed as xx/yy where xx is the minimum and yy is the maximum. An example would be 01/08 which indicates that the minimum element length is 1 character and the maximum is 8 characters.





2.3.2.3 Examples of Data Elements

Table 2.

Element identifier	Description	Element Type	Element Length Min/Max	Example
ID101	Vending Machine Serial Number	Alphanumeric AN	01/20	VMC123
ID104	Build standard	Numeric N0	01/04	6
ID106	Asset Number	Alphanumeric AN	01/20	CAN MACHINE 45
CA302	Value of Cash to Cashbox (\$5.75)	Currency Nc	01/08	575
PA102	Product price (\$1.35)	Currency Nc	01/08	135
DA201	Value of Card Sales (\$845.00)	Currency Nc	01/08	84500
EA302	Date of this audit read	Date DT	06/08	021231 or 20021231
EA303	Time of this audit read	Time TM	04/06	1345 or 134515





2.4 MANDATORY HEADERS AND TRAILERS

The following sections provide details on the mandatory Headers, Trailers, and Data Record Integrity Check.

2.4.1 Application Header and Trailer (DXS and DXE)

The **DXS** Application Header and **DXE** Application Trailer surround the transaction set or sets that are transferred from one device to the other. Note that only one **DXS** and one **DXE** are permitted within an audit or configuration file.

The vending industry conforms to the following envelope and element definitions; however, a few of the descriptions have changed over time as noted with an asterisk (*) below:

DXS -Application Header

DXS01 - COMMUNICATION ID (of sender) vending industry => 10 digit ID UCC ID or 3 character manufacturer code plus 7 digits (Note 4).	AN 10/10
DXS02 - FUNCTIONAL IDENTIFIER (*) vending industry => VA (Note 1)	ID 02/02
DXS03 - VERSION (*) vending industry => V1/1 vending industry => V0/6 (Note 3)	ID 04/12 (Note 2)
DXS04 - TRANSMISSION CONTROL NUMBER vending industry => 1	N0 01/05
DXS05 - COMMUNICATION ID (of recipient) vending industry => <u>not used / not sent</u>	AN 01/10
DXS06 - TEST CODE STATUS vending industry => <u>not used / not sent</u>	ID 01/01

DXE - Application Trailer

DXE01 - TRANSMISSION CONTROL NUMBER vending industry => 1	N0 01/05
DXE02 - NUMBER OF INCLUDED SETS vending industry => 1	N0 01/06





This variable number will be equal to the number of ST transaction sets. For a single transfer to / from a VMD, this number will always be one (1).

Note 1: VA implies Vending Audit. Existing, initial production devices may also send VX which has been grandfathered.

Note 2: V1/1 specifies the version for all VMDs prior to DTS Version 6.0. Existing, initial production devices may send VEND2 which has been grandfathered.

Note 3: V0/6 specifies the version for all VMDs starting with DTS Version 6.0.

Note 4: DTS Version 6.0 and above devices must use the 3 character manufacturing code plus 7 digits.

2.4.2. Transaction Set Header and Trailer

The **ST** Transaction Set Header and **SE** Transaction Set Trailer surround each transaction set that is transferred from one device to the other. Note that one or more Transaction Sets are permitted within an audit or configuration file; however, **only one Transaction Set is allowed from a vending machine device to a data carrier or vice versa**. Transfers from a data carrier to a business computer (or vice versa) is where more than one Transaction Set is permitted.

ST -Transaction Set Header

ST01 - TRANSACTION SET HEADER ID 03/03
vending industry => 001

ST02 - TRANSACTION SET CONTROL NUMBER AN 04/09
vending industry => 0001 or incrementing if multiple transaction sets

For a single transfer to / from a VMD, this number will always be 0001.

SE -Transaction Set Trailer

SE01 - NUMBER OF INCLUDED SETS NO 01/06
vending industry => variable

This number is the number of data segments included in the transfer starting with and including the ST and finishing with and including the SE.

SE02 - TRANSACTION SET CONTROL NUMBER AN 04/09
vending industry => 0001 or incrementing if multiple transaction sets

For a single transfer to / from a VMD, this number will always be 0001.





2.4.3. Data Record Integrity Check

Each transaction set data record has a CRC-16 based integrity check associated with it. This is based on the **DEX/UCS Delivery/Return Base Records (Transaction Sets)** as described in the **UCS/DSD Implementation Guide Section VII**.

G85 - Record Integrity Check

G8501 - INTEGRITY CHECK VALUE
vending industry => as defined

AN 04/04

The G85 Record Integrity Check is used to verify the contents of the complete transaction set from the beginning of the ST data segment to the end of the data prior to the G85 data segment. If the contents of the data are altered in any way the calculated G85 Record Integrity Check will be different signifying that part of the transaction set has been altered or corrupted.

All VMDs sending audit data must transfer the G85 data segment prior to sending the SE - Transaction Set Trailer. There is no requirement that the Data Carrier (DC) check the G85 Record Integrity Check; however, it is recommended.

All Data Carriers sending configuration data must transfer the G85 data segment prior to sending the SE - Transaction Set Trailer. There is no requirement that the VMD check the G85 Record Integrity Check; however, it is recommended.

The G85 data segment is sent as four ASCII characters (0-9, A, B, C, D, E, F) indicating the four nibbles of a CRC-16 calculation. Since the CRC-16 is based on two bytes, the most significant byte is sent first and the least significant byte is sent second. In essence, if the CRC-16 had a value of 1234h, the G85 Record Integrity Check would be sent as **G85*1234**. Early implementations of much equipment may have this order reversed, it is a reasonable test to check both orderings for systems prior to DTS version 6.0.

The G85 Record Integrity Check contains the data segments from the beginning of the Transaction Set Header data segment (starts with the "S" in the ST) to the "CRLF" (carriage return / line feed) at the end of the data prior to the G85 data segment.





The data elements contained in the G85 Record Integrity Check are shown in **bold print**.

DXS*XYZ1234567*VA*V0/6*1crlf	Application Header
ST*001*0001crlf	Transaction Set Header
ID1*ABC98765*****12234crlf	Identification data segment
VA1*4550*2450crlf	Vend Transaction data segment
VA3*91*49crlf	Free Vend Transaction data segment
CA3*****2700*225*475*2000crlf	Cash In data segment
CA4***250*0crlf	Cash Out data segment
EA2*EGS*****0crlf	Event Information data segment
EA3*****24*10crlf	Number of Reads data segment
G85*1234crlf	Record Integrity Check (example)
SE*10*0001crlf	Transaction Set Trailer
DXE*1*1crlf	Application Trailer

It should be noted that the G85 Record Integrity Check does not contain any of the control characters used by the protocol (DEX, DDCMP, or any other) to transfer the data.

The CRC -16 algorithm is based on the following generating function:

$$G(x) = x^{16} + x^{15} + x^2 + x^0$$

All examples in the Data Transfer Standard depict the G85 as 1234 to indicate the order of the bytes as transferred. **Obviously, the correct CRC should be transmitted.**

Also note that the G85 is sent in the opposite order of the DEX protocol block CRC (see Chapter 4.4).





2.4.4 Example Report

The following is an example of an Audit Report and a Configuration Report.

Audit Report:

DXS*XYZ1234567*VA*V0/6*1	Application header (Mandatory Header)
ST*001*0001	Transaction Set header (Mandatory Header)
ID1*ABC98765*****11223344	Identification data segment
VA1*1000*200	Vend Transaction data segment
VA3*50*1	Free Vend Transaction data segment
CA3*****1250*250*400*6	Cash In data segment
CA4***250*0	Cash Out data segment
PA1*1*50*****	Product 1 Information data segment
PA4*1	Product 1 Free Vend Transaction data segment
PA7*1*CA*0*50*72*3600*11*550	Product 1 Cash Transaction data segment
PA7*1*DA*1*50*756*37800*121*6050	Product 1 Cashless 1 Transaction data segment
PA7*1*DA*2*25*33*825*4*100	Product 1 Cashless 1 Transaction data segment
PA1*2*50*****	Product 2 Information data segment
PA4*0	Product 2 Free Vend Transaction data segment
PA7*2*CA*0*50*40*2000*10*500	Product 2 Cash Transaction data segment
PA7*2*DA*1*50*600*30000*100*5000	Product 2 Cashless 1 Transaction data segment
PA7*2*DA*2*25*30*750*2*50	Product 2 Cashless 1 Transaction data segment
EA2*EGS****1	Event Information
EA3*****24*10	Number of Reads Information
G85*1234	Record Integrity Check (Mandatory)
SE*16*0001	Transaction Set trailer (Mandatory Trailer)
DXE*1*1	Application trailer (Mandatory Trailer)





Configuration Report:

DXS*XYZ1234567*VA*V0/6*1	Application header (Mandatory Header)
ST*001*0001	Transaction Set header (Mandatory Header)
IC1*****987654	Identification data segment
PC7*1*CA*0*50	Product 1 Information data segment
PC7*1*DA*1*50	Product 1 Information data segment
PC7*1*DA*2*25	Product 1 Information data segment
G85*1234	Record Integrity Check (Mandatory)
SE*06*0001	Transaction Set trailer (Mandatory Trailer)
DXE*1*1	Application trailer (Mandatory Trailer)

2.5 RECOMMENDED AUDIT REPORT

The following table includes the recommended data elements which have to be transferred from a vending machine device. Data which does not exist because for example no cashless payment system is available do not have to be transferred. For additional data which exceeds the defined amount of data a co-ordination with the manufacturer of the relevant device is necessary.

Below you will find a list of most useful elements which an operator may expect.

Some audit information is available in two forms: "Since Initialisation" and "Since Last Reset". In this case at least one of them has to be transferred.

The following table lists the data elements which are necessary to create a report of the cash flow in a vending machine. For a full list of data elements see appendix A.





Block Identifier	Data Element Number	Element Description	Type	
DXS	01 – M	COMMUNICATION ID OF SENDER	AN	
	02 – M	FUNCTIONAL IDENTIFIER (VA)	ID	
	03 – M	VERSION (0/6)	ID	
	04 – M	TRANSMISSION CONTROL NUMBER (1)	N0	
	05 – O	COMMUNICATION ID OF RECIPIENT	AN	
ST	01 – M	TRANSACTION SET HEADER (001)	ID	
	02 – M	TRANSACTION SET CONTROL NUMBER (0001)	AN	
AM1		01 – O	AUDIT MODULE / COMMS GATEWAY SERIAL NUMBER	AN
		02 – O	AUDIT MODULE / COMMS GATEWAY MODEL NUMBER	AN
		03 – O	AUDIT MODULE / COMMS GATEWAY SOFTWARE REVISION	N0
	AC 1	05 – CM ^{CG}	AUDIT MODULE / COMMS GATEWAY ASSET NUMBER	AN
ID1		01 – O	MACHINE SERIAL NUMBER	AN
		02 – O	MACHINE MODEL NUMBER	AN
		03 – O	MACHINE BUILD STANDARD	N0
	IC1	04 – O	MACHINE LOCATION	AN
	IC1	06 – M	MACHINE ASSET NUMBER	AN
ID4		01 – O	DECIMAL POINT POSITION	N0
		02 – O	CURRENCY NUMERIC CODE	N0
		03 – O	CURRENCY ALPHABETIC CODE	AN
ID6	IC6	01 – M	CURRENT CASH BAG NUMBER	AN
CB1		01 – O	VMC CONTROL BOARD SERIAL NUMBER	AN





Block Identifier	Data Element Number	Element Description	Type
	02 – O	VMC CONTROL BOARD MODEL NUMBER	AN
	03 – CM	VMC CONTROL BOARD BUILD STANDARD	AN
VA1	01 – M	VALUE OF ALL PAID VEND SALES SINCE INITIALIZATION	Nc
	02 – M	NUMBER OF ALL PAID VEND SALES SINCE INITIALIZATION	N0
	03 – O	VALUE OF ALL PAID VEND SALES SINCE LAST RESET	Nc
	04 – O	NUMBER OF ALL PAID VEND SALES SINCE LAST RESET	N0
VA2	01 – O	TEST VEND VALUE OF SALES SINCE INITIALIZATION	Nc
	02 – O	NUMBER OF TEST VENDS SINCE INITIALIZATION	N0
	03 – O	TEST VEND VALUE OF SALES SINCE LAST RESET	Nc
	04 – O	NUMBER OF TEST VENDS SINCE LAST RESET	N0
VA3	01 – M	FREE VEND VALUE OF SALES SINCE INITIALIZATION	Nc
	02 – M	NUMBER OF FREE VEND SALES SINCE INITIALIZATION	N0
	03 – O	FREE VEND VALUE OF SALES SINCE LAST RESET	Nc
	04 – O	NUMBER OF FREE VEND SALES SINCE LAST RESET	N0
CA1	01 – $\frac{M^{CM}}{O^{VMC/VMD}}$	CHANGER SERIAL NUMBER	AN
	02 – $\frac{M^{CM}}{O^{VMC/VMD}}$	COIN MECHANISM MODEL NUMBER	AN
	03 – $\frac{M^{CM}}{O^{VMC/VMD}}$	COIN MECHANISM SOFTWARE REVISION	N0
CA2	01 – $\frac{M^{CM}}{O^{VMC/VMD}}$	VALUE OF CASH SALES SINCE INITIALIZATION	Nc
	02 – $\frac{M^{CM}}{O^{VMC/VMD}}$	NUMBER OF CASH VENDS SINCE INITIALIZATION	N0





Block Identifier	Data Element Number	Element Description	Type
	03 - M ^{CM} / O _{VMC/VMD}	VALUE OF CASH SALES SINCE LAST RESET	Nc
	04 - M ^{CM} / O _{VMC/VMD}	NUMBER OF CASH VENDS SINCE LAST RESET	NO
CA3	01 - O	VALUE OF CASH IN SINCE LAST RESET	Nc
	02 - O	VALUE OF CASH TO CASH BOX SINCE LAST RESET	Nc
	03 - O	VALUE OF CASH TO TUBES SINCE LAST RESET	Nc
	04 - O (NOTE 6) (NOTE 6)	VALUE OF BILLS IN SINCE LAST RESET	NO / Nc
	05 - O	VALUE OF CASH IN SINCE INITIALIZATION	Nc
	06 - CM	VALUE OF CASH TO BOX SINCE INITIALIZATION	Nc
	07 - CM	VALUE OF CASH TO TUBES SINCE INITIALIZATION	Nc
	08 - CM (NOTE 6)	VALUE OF BILLS IN SINCE INITIALIZATION	NO / Nc
	09 - O (NOTE 6)	VALUE OF BILLS IN SINCE LAST RESET	Nc
	10 - CM (NOTE 6)	VALUE OF BILLS IN SINCE INITIALIZATION	Nc
	11 - CM	VALUE OF BILLS TO RECYCLER SINCE LAST RESET	Nc
	12 - CM	VALUE OF BILLS TO RECYCLER SINCE INITIALIZATION	Nc
CA4	01 - O	VALUE OF CASH DISPENSED SINCE LAST RESET	Nc
	02 - O	VALUE OF MANUAL CASH DISPENSED SINCE LAST RESET	Nc
	03 - CM	VALUE OF CASH DISPENSED SINCE INITIALIZATION	Nc
	04 - CM	VALUE OF MANUAL CASH DISPENSED SINCE INITIALIZATION	Nc
	05 - CM	VALUE OF BILLS DISPENSED SINCE LAST RESET	Nc





Block Identifier	Data Element Number	Element Description	Type
	06 – CM	VALUE OF BILLS MANUALLY DISPENSED SINCE LAST RESET	Nc
	07 – CM	VALUE OF BILLS TRANSFERRED TO RECYCLER SINCE LAST RESET	Nc
	08 – CM	VALUE OF BILLS DISPENSED SINCE INITIALISATION	Nc
	09 – CM	VALUE OF BILLS MANUALLY DISPENSED SINCE INITIATLISATION	Nc
	10 – CM	VALUE OF BILLS TRANSFERRED TO RECYCLER SINCE INITIATLISATION	Nc
CA8	01 – O	VALUE OF CASH OVERPAY SINCE LAST RESET	Nc
	02 – CM	VALUE OF CASH OVERPAY SINCE INITIALIZATION	Nc
CA10	01 – O	VALUE OF CASH FILLED SINCE LAST RESET	Nc
	02 – CM	VALUE OF CASH FILLED SINCE INITIALIZATION	Nc
	03 – O	VALUE OF BILLS FILLED SINCE LAST RESET	Nc
	04 – CM	VALUE OF BILLS FILLED SINCE INITIALISATION	Nc
CA16	01 – O	VALUE CREDITED FROM MACHINE SINCE LAST RESET	Nc
	02 – CM (Note 7)	VALUE CREDITED FROM MACHINE SINCE INITIALIZATION	Nc
BA1	01 – O	BILL VALIDATOR SERIAL NUMBER	AN
	02 – O	BILL VALIDATOR MODEL NUMBER	AN
	03 – O	BILL VALIDATOR SOFTWARE REVISION	N0
DA1	01 – M ^{CD} / O ^{VMC}	CASHLESS 1 SERIAL NUMBER	AN
	02 – M ^{CD} / O ^{VMC}	CASHLESS 1 MODEL NUMBER	AN
	03 – M ^{CD} / O ^{VMC}	CASHLESS 1 SOFTWARE REVISION	N0
DA2	01 – CM	VALUE OF CASHLESS 1 SALES SINCE INITIALIZATION	Nc





Block Identifier	Data Element Number	Element Description	Type
	02 – CM	NUMBER OF CASHLESS 1 SALES SINCE INITIALIZATION	N0
	03 – O	VALUE OF CASHLESS 1 SALES SINCE LAST RESET	Nc
	04 – O	NUMBER OF CASHLESS 1 SALES SINCE LAST RESET	N0
DA4	01 – CM	VALUE OF CREDIT TO CASHLESS 1 SINCE INITIALIZATION	Nc
	02 – O	VALUE OF CREDIT TO CASHLESS 1 SINCE LAST RESET	Nc
DA7	01 – CM (Note 5)	CASHLESS 1 USER GROUP NUMBER	N0
	02 – O	CASHLESS 1 USER GROUP NET SALES SINCE LAST RESET	Nc
	03 – O	CASHLESS 1 USER GROUP VALUE ADDED TO CARD SINCE LAST RESET	Nc
	04 – O	CASHLESS 1 USER GROUP VALUE OF CARD DISCOUNTS SINCE LAST RESET	Nc
	07 – CM (Note 5)	CASHLESS 1 USER GROUP NET SALES SINCE INITIALISATION	Nc
	08 – CM (Note 5)	USER GROUP VALUE ADDED TO CASHLESS 1 SINCE INITIALISATION	Nc
	09 – CM (Note 5)	USER GROUP VALUE OF CASHLESS 1 DISCOUNTS SINCE INITIALISATION	Nc
DA10	01 – CM	CASHLESS 1 NUMBER OF MIXED PAYMENT VENDS SINCE INITIALISATION	N0
	02 -- CM	CASHLESS 1 VALUE OF MIXED PAYMENT CASHLESS AMOUNT SINCE INITIALISATION	Nc
	03 – CM	CASHLESS 1 NUMBER OF MIXED PAYMENT VENDS SINCE LAST RESET	N0
	04 – CM	CASHLESS 1 VALUE OF MIXED PAYMENT CASHLESS AMOUNT SINCE LAST RESET	Nc





Block Identifier	Data Element Number	Element Description	Type
DB1	01 – M ^{CD} / O ^{VMC}	CASHLESS 2 SERIAL NUMBER	AN
	02 – M ^{CD} / O ^{VMC}	CASHLESS 2 MODEL NUMBER	AN
	03 – M ^{CD} / O ^{VMC}	CASHLESS 2 SOFTWARE REVISION	N0
DB2	01 – CM	VALUE OF CASHLESS 2 SALES SINCE INITIALIZATION	Nc
	02 – CM	NUMBER OF CASHLESS 2 SALES SINCE INITIALIZATION	N0
	03 – O	VALUE OF CASHLESS 2 SALES SINCE LAST RESET	Nc
	04 – O	NUMBER OF CASHLESS 2 SALES SINCE LAST RESET	N0
DB4	01 – CM	VALUE OF CREDIT TO CASHLESS 2 SINCE INITIALIZATION	Nc
	02 – O	VALUE OF CREDIT TO CASHLESS 2 SINCE LAST RESET	Nc
DB7	01 – CM (Note 5)	USER GROUP NUMBER	N0
	02 – O	CASHLESS 2 USER GROUP NET SALES SINCE LAST RESET	Nc
	03 – O	CASHLESS 2 USER GROUP VALUE ADDED TO CARD SINCE LAST RESET	Nc
	04 – O	CASHLESS 2 USER GROUP VALUE OF CARD DISCOUNTS SINCE LAST RESET	Nc
	07 – CM (Note 5)	CASHLESS 2 USER GROUP NET SALES SINCE INITIALISATION	Nc
	08 – CM (Note 5)	USER GROUP VALUE ADDED TO CASHLESS 2 SINCE INITIALISATION	Nc
	09 – CM (Note 5)	USER GROUP VALUE OF CASHLESS 2 DISCOUNTS SINCE INITIALISATION	Nc
DB10	01 – CM	CASHLESS 2 NUMBER OF MIXED PAYMENT VENDS SINCE INITIALISATION	N0





Block Identifier	Data Element Number	Element Description	Type
	02 -- CM	CASHLESS 2 VALUE OF MIXED PAYMENT CASHLESS AMOUNT SINCE INITIALISATION	Nc
	03 – CM	CASHLESS 2 NUMBER OF MIXED PAYMENT VENDS SINCE LAST RESET	N0
	04 – CM	CASHLESS 2 VALUE OF MIXED PAYMENT CASHLESS AMOUNT SINCE LAST RESET	Nc
HA1	01 – M^{CM} / $O_{VMC/VMD}$	HOPPER/DISPENSER SERIAL NUMBER	AN
	02 – M^{CM} / $O_{VMC/VMD}$	HOPPER/DISPENSER MODEL NUMBER	AN
	03 – M^{CM} / $O_{VMC/VMD}$	HOPPER/DISPENSER SOFTWARE REVISION	N0
HA2	01 – O	VALUE OF CASH IN SINCE LAST RESET	Nc
	02 – O	VALUE OF CASH FILLED SINCE LAST RESET	Nc
	03 – CM	VALUE OF CASH IN SINCE INITIALISATION	Nc
	04 – CM	VALUE OF CASH FILLED SINCE INITIALISATION	N0 / Nc
HA3	01 – O	VALUE OF CASH DISPENSED SINCE LAST RESET	Nc
	02 – O	VALUE OF CASH MANUALLY DISPENSED SINCE LAST RESET	Nc
	03 – CM	VALUE OF CASH DISPENSED SINCE INITIALISATION	Nc
	04 – CM	VALUE OF CASH MANUALLY DISPENSED SINCE INITIALISATION	Nc
HB1	01 – M^{CM} / $O_{VMC/VMD}$	HOPPER/DISPENSER SERIAL NUMBER	AN
	02 – M^{CM} / $O_{VMC/VMD}$	HOPPER/DISPENSER MODEL NUMBER	AN





Block Identifier	Data Element Number	Element Description	Type	
	03 - M ^{CM} / O ^{VMD/VMD}	HOPPER/DISPENSER SOFTWARE REVISION	N0	
HB2	01 - O	VALUE OF CASH IN SINCE LAST RESET	Nc	
	02 - O	VALUE OF CASH FILLED SINCE LAST RESET	Nc	
	03 - CM	VALUE OF CASH IN SINCE INITIALISATION	Nc	
	04 - CM	VALUE OF CASH FILLED SINCE INITIALISATION	N0 / Nc	
HB3	01 - O	VALUE OF CASH DISPENSED SINCE LAST RESET	Nc	
	02 - O	VALUE OF CASH MANUALLY DISPENSED SINCE LAST RESET	Nc	
	03 - CM	VALUE OF CASH DISPENSED SINCE INITIALISATION	Nc	
	04 - CM	VALUE OF CASH MANUALLY DISPENSED SINCE INITIALISATION	Nc	
TA2	01 - CM	VALUE OF TOKEN (COUPON) SALES SINCE INITIALIZATION	Nc	
	02 - CM	NUMBER OF TOKEN (COUPON) SALES SINCE INITIALIZATION	N0	
	03 - O	VALUE OF TOKEN (COUPON) SALES SINCE LAST RESET	Nc	
	04 - O	NUMBER OF TOKEN (COUPON) SALES SINCE LAST RESET	N0	
	05 - CM	VALUE OF VALUE TOKEN (COUPON) SALES SINCE INITIALIZATION	Nc	
	06 - CM	NUMBER OF VALUE TOKEN (COUPON) SALES SINCE INITIALIZATION	N0	
	07 - O	VALUE OF VALUE TOKEN (COUPON) SALES SINCE LAST RESET	Nc	
	08 - O	NUMBER OF VALUE TOKEN (COUPON) SALES SINCE LAST RESET	N0	
PA1	PC1	01 - M (Note 2)	PRODUCT IDENTIFIER (Recommend: Product Identifier = Panel Selection #)	AN





Block Identifier	Data Element Number	Element Description	Type	
	PC1	02 - O (Note 2)	PRICE	Nc
	PC1	03 - O (Note 2)	PRODUCT IDENTIFICATION	AN
	PC1	07 - M (Note 2,3)	SELECTION STATUS (0 or blank (recommended) = Selection Present) (1 = Selection Not Present)	N0
	PC1	08 - CM	CURRENT PRODUCT LEVEL	N0
	PC1	09 - CM	MINIMUM PRODUCT LEVEL	N0
PA2		01 - CM (Note 1)	NUMBER OF PAID PRODUCTS VENDED SINCE INITIALIZATION	N0
		02 - CM (Note 1)	VALUE OF PAID PRODUCTS VENDED SINCE INITIALIZATION	Nc
		03 - CM (Note 1)	NUMBER OF PAID PRODUCTS VENDED SINCE LAST RESET	N0
		04 - O	VALUE OF PAID PRODUCTS VENDED SINCE LAST RESET	Nc
		05 - CM (Note 1)	NUMBER OF DISCOUNTS SINCE INITIALIZATION	N0
		06 - CM (Note 1)	VALUE OF DISCOUNTS SINCE INITIALIZATION	Nc
		07 - O	NUMBER OF DISCOUNTS SINCE LAST RESET	N0
		08 - O	VALUE OF DISCOUNTS SINCE LAST RESET	Nc
		09 - O	NUMBER OF SURCHARGED PAID SINCE INITIALIZATION	N0
		10 - O	VALUE OF SURCHARGES PAID SINCE INITIALIZATION	Nc
		11 - O	NUMBER OF SURCHARGED PAID SINCE LAST RESET	N0
		12 - O	VALUE OF SURCHARGES PAID SINCE LAST RESET	Nc





Block Identifier	Data Element Number	Element Description	Type
PA4	01 – M	NUMBER OF FREE VENDS SINCE INITIALIZATION	N0
	02 – O	VALUE OF FREE VENDS SINCE INITIALIZATION	Nc
	03 – O	NUMBER OF FREE VENDS SINCE LAST RESET	N0
	04 – O	VALUE OF FREE VENDS SINCE LAST RESET	Nc
	05 – CM	NUMBER OF FREE VENDS WITHOUT CUP SINCE INITIALISATION	N0
	06 – CM	NUMBER OF FREE VENDS WITHOUT CUP SINCE LAST RESET	N0
PA5	01 – O	DATE OF MOST RECENT SALE	DT
	02 – O	TIME OF MOST RECENT SALE	TM
PA7	PC7 01 – CM (Note 1)	PRODUCT NUMBER	AN
	PC7 02 – CM (Note 1)	PAYMENT DEVICE	AN
	PC7 03 – CM (Note 1)	PRICE LIST NUMBER	N0
	PC7 04 – CM (Note 1)	APPLIED PRICE	Nc
	05 – CM (Note 1)	NUMBER OF SALES SINCE INITIALISATION	N0
	06 – CM (Note 1)	VALUE OF SALES SINCE INITIALISATION	Nc
	07 – CM (Note 1)	NUMER OF SALES SINCE LAST RESET	N0
	08 – CM (Note 1)	VALUE OF SALES SINCE LAST RESET	Nc
PA8	01 – CM	NUMBER OF MIXED PAYMENT VENDS SINCE INITIALISATION	N0
	02 – CM	VALUE OF MIXED PAYMENT CASH AMOUNT SINCE INITIALISATION	Nc
	03 – CM	NUMBER OF MIXED PAYMENT VENDS SINCE LAST RESET	N0
	04 – CM	VALUE OF MIXED PAYMENT CASH AMOUNT SINCE LAST RESET	Nc
EA1	01 – O (Note 4)	EVENT IDENTIFICATION	AN





Block Identifier	Data Element Number	Element Description	Type
	02 - O	DATE OF EVENT	DT
	03 - O	TIME OF EVENT	TM
	04 - O	DURATION OF EVENT IN MINUTES	N0
EA2	01 - M (Note 4)	EVENT IDENTIFICATION	AN
	02 - O	NUMBER OF EVENTS SINCE LAST RESET	N0
	03 - O	NUMBER OF EVENTS SINCE INITIALIZATION	N0
	05 - M	CURRENT EVENT ACTIVITY (1=ACTIVE / 0 (OR BLANK) =INACTIVE)	N0
	06 - O	DURATION OF EVENT(S) IN MINUTES (includes multiple occurrences)	N0
EA3	01 - O	NUMBER OF READS WITH RESET SINCE INITIALIZATION	N0
	02 - O	DATE OF THIS READOUT	DT
	03 - O	TIME OF THIS READOUT	TM
	04 - O	TIME TERMINAL / INTERROGATOR IDENTIFICATION	AN
	05 - O	DATE OF LAST READ OUT	DT
	06 - O	TIME OF LAST READ OUT	TM
	07 - O	LAST TERMINAL / INTERROGATOR IDENTIFICATION	AN
	09 - M	NUMBER OF READS WITH OR WITHOUT RESET SINCE INITIALIZATION	N0
	10 - M	NUMBER OF RESETS SINCE INITIALIZATION (Not Event Resets) (RESETs can be automatic after a read, via the SD105 RESET command, partial via SD104, or manual via a machine service mode)	N0
EA7	01 - O	NUMBER OF POWER OUTAGES SINCE LAST RESET	N0





Block Identifier	Data Element Number	Element Description	Type
	02 – O	NUMBER OF POWER OUTAGES SINCE INITIALIZATION	N0
SD1	01 – O	CURRENT PASSWORD	AN
	02 – O	NEW PASSWORD	CD
	03 – O	REPORTING INSTRUCTIONS	CD
	04 – O	RESET SELECTED DATA	CD
	05 – M	RESET ALL INTERVAL DATA CONTROL (AUTO, SAVE, RESET)	CD
	06 – M	RESET EVENTS CONTROL (AUTO, SAVE, RESET)	CD
G85	01 – M	RECORD INTEGRITY CHECK	AN
SE	01 – M	NUMBER OF INCLUDED SETS (Variable Number)	N0
	02 – M	TRANSACTION SET CONTROL NUMBER (Normally 0001)	N0
DXE	01 – M	TRANSMISSION CONTROL NUMBER (1)	N0
	02 – M	NUMBER OF INCLUDED SETS (1)	N0



M = Mandatory (must be transferred)

O = Optional (recommended element if manufacturer can support)

CM = Conditional Mandatory (required if the device or feature is present in vending system)

M^{CM}/O^{VMC} = Mandatory if VMD is Coin Mech or Optional if VMD is VMC

M^{CD}/O^{VMC} = Mandatory if VMD is Cashless Device or Optional if VMD is VMC

M^{CG}/O^{VMC} = Mandatory if VMD is communication gateway or Optional if VMD is VMC

The column "Block Identifier" also lists configuration elements (IC1, ...). The list shows the minimum requirement.

Note 1 – Refer chapter 5.1.7 (As from EVA-DTS version 6.1 the PA2 and LA elements shall be grandfathered as far as PA7 reporting is fully implemented. In markets where the price list feature is uncommon and rarely used, it is still allowed to use PA2. If cashless in combination with pricelists are used in the machines, PA7 must be implemented. It is also recommended to use PA7 for all new designs).

Note 2 – If motor / actuator / mechanism present or historical (since initialization) data is present.

Note 3 – An example of a 1 being sent would be if the motor/actuator/mechanism was present previously, and something occurred so that it is not being currently detected (i.e., removed, broken wire, etc.) It is **not** intended to indicate that a product is not available for vending (i.e., sold out).

Note 4 - If the machine detects events, see section 2.8 for reporting details.

Note 5 – If cashless device supports User Groups.

Note 6 – Historically CA304 and CA308 have used two different formats. These formats are used in a wide installed base and must be maintained in existing and new designs for 5 years from the introduction of Version 6.0 (until 2009). After this date, new designs need only send CA309 and CA310. Check with equipment suppliers to verify their formatting.



Implemented formats include:

1) In older North American implementations, the value of the note is divided by 100, and is sent as an N0 data type.

Example: A \$5.00 bill is sent as 5. A \$20.00 bill is sent as 20.

2) In most European implementations, the value of the note is not divided by 100, and is sent as an Nc data type.

Example: A €5.00 bill is sent as 500. A €20.00 bill is sent as 2000.

Note 7 – Example, for bottle return machines.

2.6 RESETTING INTERVAL DATA ELEMENTS

Interval data elements have the ability to be reset back to zero for ease of accumulating data between different audit transfers. The following sections describe the different methods to reset the elements provided by the **Data Transfer Standard**.

2.6.1 Interval Data Elements (All)

Resetting all the interval data elements is controlled by the **SD105** element per below. Note that this is a mandatory function.

AUTO - Sending **AUTO** puts the vending machine device (VMD) into a specific operational mode. The interval data will be automatically reset after each successful read transfer. This mode will stay in effect until a **SAVE** command is received. This will be the default state for vending machine devices.

SAVE - Sending **SAVE** puts the vending machine device (VMD) into a specific operational mode. The interval data will not be automatically reset after each read transfer. This mode will stay in effect until an **AUTO** command is received.

RESET - Sending **RESET** is a command to the vending machine device (VMD). All interval data will be reset after the current successful SD105 transfer. Sending **RESET** does not change the **AUTO** or **SAVE** mode of the VMD.

Note: Some VMCs may allow data to be reset locally at the machine via a special **SERVICE** mode.





2.6.2 Interval Data Elements (Selective)

Resetting **selective** interval data groups will be controlled by the **SD104**. This will be an optional function. Note that only groups of elements identified by the <block identifier> are selectable for resetting, not the individual data elements. This is accomplished by listing the <block identifiers> separated by commas. For selective resetting to be effective, the vending machine device must have been previously set to **SAVE** mode via the SD105 element. It is optional whether or not the **SAVE** mode command is resent in SD105.

Examples are shown below:

The CA3xx and CA4xx resettable elements are to be reset. The specified group(s) of "since last reset" data elements will be reset after the following successful SD104 transfer.

SD1**CA3, CA4**

The VA1xx, CA2xx, and DA2xx resettable elements are to be reset. The specified group(s) of "since last reset" data elements will be reset after the following successful SD104 transfer. The SD105 "SAVE" command can be optionally sent to continue the "save" mode of operation.

SD1**VA1, CA2, DA2*SAVE** (optional, continues **SAVE** mode)

It should be noted that for both the SD105 and SD104 commands above, since these are configuration type elements, they are sent to the vending machine device (VMD) from the Data Carrier (DC). For the DEX/UCS protocol, this requires a separate First and Second Handshake to set the direction of data transfer (to the VMD). In a typical scenario when the VMD is in the SAVE mode, the audit would be performed first and then the RESET command would be sent.

First Handshake	DC to VMD
Second Handshake	VMD to DC
Data Transfer (Audit Data)	VMD to DC
First Handshake	DC to VMD
Second Handshake	VMD to DC
Data Transfer (SD105 = RESET)	DC to VMD





2.7 DATA REPORTING

2.7.1 Selective Reporting of Data

Although all of the data elements are typically transferred from the vending machine device to the data carrier, there is a provision in the **Data Transfer Standard** to transfer selected groups of data elements.

If the number of elements to be read out is required to be modified, then the SD103 element should be sent to the VMD specifying which elements are to be read out at the next read out.

The SD103 data element identifies a list of the groups of elements that will be reported during an audit. Note that the structure is similar to the SD104 Selective Resets as described in Section 2.6.2.

Selecting data groups is controlled by the SD103. This is an optional function. Note that only groups of elements identified by the <block identifier> are selectable for reporting, not the individual data elements. This is accomplished by listing the <block identifiers> separated by commas.

Examples of sending the reporting list are shown below:

The CA301 to CA304 elements and CA401 & CA402 elements are to be reported.

SD1*CA3, CA4**

The VA103 & VA104, CA203 & CA204, and DA203 & DA204 elements are to be reported.

SD1*VA1,CA2, DA2**

If there are no elements in the SD103 transferred to the vending machine device, all the data elements are transferred from the vending machine device to the data carrier at the next readout. By default, or if the SD103 is left blank, then all available data will be read out.

It should be noted that elements identified by SD103 as elements to be transferred from the vending machine device to the data carrier at the next readout only are identified after the readout. The SD103 data element has to be transferred to the vending machine device every time readout of selected data elements is wanted.



2.7.2 Reporting of Data using lists

The recommended Audit Report specified in Section 2.5 is defined as Audit Collection list (List 1).

In DDCMP protocol additional lists are specified as defined in Section 3.6

2.8 EVENT REPORTING INSTRUCTIONS

Events are occurrences in a vending machine device that get stored and reported to the data carrier when an audit is performed. Although events can often be faults in a machine, they also indicate normal functions such as door openings or closings. The EA1 data segment captures the date, time, and duration of the event and the EA2 data segment captures the number of the events.

To minimize the amount of data to be transferred, fault reference codes are sent using a three or four character structured code segmented as follows:

<u>First Letter</u>	<u>Second Letter</u>	<u>Third Letter & Optional #</u>
E - Equipment	Event Unit affected Code	Specific Event Code
O - Operational Event	Operation Affected Code	Specific Event Code

Appendix C lists the complete Equipment Events (E based codes) and Operational Events (O based codes).

The following sections describe the operation of the events with respect to reporting and resetting / clearing.

EVENT States

Events will have three states:

State 1 - No Incidence & Not Active – An EVENT is not occurring and is inactive. This is the normal state of EVENTS, i.e., not happening.

State 2 - Incidence & Active – An EVENT has occurred and it is currently active.

This is the state of an EVENT that has occurred and has not been repaired or corrected itself.

State 3 - Incidence & Not Active – An EVENT has occurred and is currently inactive.

This is the state of an EVENT that has occurred and has been repaired or corrected itself.



2.8.1 Event Inclusion

An EVENT will only be included in an audit (i.e., the EA201 & EA205 sent) if it is in **State 2** or **State 3**. Historical events (**State 1**) are not transmitted. In essence, an EVENT is only sent if it occurred since the last transmission and is still active or if it occurred since the last audit and has been repaired or corrected itself.

This allows EVENTS to be detected by the host system regardless of whether or not they are currently active.

2.8.2 Event Resetting / Clearing

EVENTs can only be reset/cleared by the Data Transfer Standard (DEX/UCS or Enhanced DDCMP (eDDCMP) and only if they are in **State 3**. In essence, an EVENT can only be reset if it is not active, i.e., the EVENT has been fixed at the machine or has corrected itself. This allows all vending machine reportable EVENTS to be logged by the Host System and does not allow an active EVENT to be cleared/reset before a repair is made or it corrects itself.

The **SD106** data element operates similar to the **SD105**. This allows for flexibility in the resetting/clearing of EVENT reporting.

- AUTO** - Sending **AUTO** in **SD106** puts the vending machine device (VMD) into a specific operational EVENT mode. All **State 3** EVENTS will be automatically reset after each successful read transfer. This mode will stay in effect until a **SAVE** command is received. This will be the default state for vending machine devices.
- SAVE** - Sending **SAVE** in **SD106** puts the vending machine device (VMD) into a specific operational EVENT mode. **State 3** EVENTS will not be automatically reset after each read transfer. This mode will stay in effect until an **AUTO** command is received.
- RESET** - Sending **RESET** is a command to the vending machine device (VMD). All **State 3** EVENTS will be reset after the current successful SD105 transfer. Sending **RESET** does not change the **AUTO** or **SAVE** mode of the VMD.





2.8.3 Event Reporting Examples

The following examples are provided to better understand the EVENT reporting mechanism. Note that the EVENT codes are defined in Appendix C and are highlighted in **bold**.

Example 1

The following mandatory data elements provide the basic EVENT information required by the host system. This EVENT is in the STATE 2 category.

EA201 indicates EVENT EGS which is defined as Door Open
EA205 indicates that the EVENT EGS is currently active (the door is open)

DXS*XYZ1234567*VA*V0/6*1	Application header (Mandatory Header)
ST*001*0001	Transaction Set header (Mandatory Header)
ID1*ABC98765*****11223344	Identification data segment
VA1*1000*200	Vend Transaction data segment
VA3*50*1	Free Vend Transaction data segment
CA3*****1250*250*400*6	Cash In data segment
CA4***250*0	Cash Out data segment
PA1*1*50*****	Product 1 Information data segment
PA4*1	Product 1 Free Vend Transaction data segment
PA7*1*CA*0*50*72*3600*11*550	Product 1 Cash Transaction data segment
PA7*1*DA*1*50*756*37800*121*6050	Product 1 Cashless 1 Transaction data segment
PA7*1*DA*2*25*33*825*4*100	Product 1 Cashless 1 Transaction data segment
PA1*2*50*****	Product 2 Information data segment
PA4*0	Product 2 Free Vend Transaction data segment
PA7*2*CA*0*50*40*2000*10*500	Product 2 Cash Transaction data segment
PA7*2*DA*1*50*600*30000*100*5000	Product 2 Cashless 1 Transaction data segment
PA7*2*DA*2*25*30*750*2*50	Product 2 Cashless 1 Transaction data segment
EA2*EGS****1	Event Information
EA3*****24*10	Number of Reads Information
G85*1234	Record Integrity Check (Mandatory)
SE*16*0001	Transaction Set trailer (Mandatory Trailer)
DXE*1*1	Application trailer (Mandatory Trailer)





Example 2

The example above can be expanded to show additional optional EVENT information. The following data elements provide optional and basic EVENT information required by the host system. This EVENT is in the STATE 3 category.

EA101 indicates EVENT EGS which is defined as Door Open

EA102 indicates the EVENT took place on 24 June, 2002

EA103 indicates the EVENT took place at 14:30

EA104 indicates the EVENT has occurred for 52 minutes

EA201 indicates EVENT EGS which is defined as Door Open

EA202 indicates the EVENT has occurred 4 times since the last audit

EA203 indicates the EVENT has occurred 36 time since initialization

EA205 indicates that the EVENT EGS is currently inactive (the door is closed)

DXS*XYZ1234567*VA*V0/6*1	Application header (Mandatory Header)
ST*001*0001	Transaction Set header (Mandatory Header)
ID1*ABC98765*****11223344	Identification data segment
VA1*1000*200	Vend Transaction data segment
VA3*50*1	Free Vend Transaction data segment
CA3*****1250*250*400*6	Cash In data segment
CA4***250*0	Cash Out data segment
PA1*1*50*****	Product 1 Information data segment
PA4*1	Product 1 Free Vend Transaction data segment
PA7*1*CA*0*50*72*3600*11*550	Product 1 Cash Transaction data segment
PA7*1*DA*1*50*756*37800*121*6050	Product 1 Cashless 1 Transaction data segment
PA7*1*DA*2*25*33*825*4*100	Product 1 Cashless 1 Transaction data segment
PA1*2*50*****	Product 2 Information data segment
PA4*0	Product 2 Free Vend Transaction data segment
PA7*2*CA*0*50*40*2000*10*500	Product 2 Cash Transaction data segment
PA7*2*DA*1*50*600*30000*100*5000	Product 2 Cashless 1 Transaction data segment
PA7*2*DA*2*25*30*750*2*50	Product 2 Cashless 1 Transaction data segment
EA1*EGS*020624*1430*52	Event Timed Information
EA2*EGS*4*36**0	Event Information
EA3*****24*10	Number of Reads Information
G85*1234	Record Integrity Check (Mandatory)
SE*17*0001	Transaction Set trailer (Mandatory Trailer)
DXE*1*1	Application trailer (Mandatory Trailer)





Example 3

The previous example can be further expanded to show additional related EVENTS and their information. The following data elements provide optional and basic EVENT information required by the host system. The door open EVENT is in the STATE 3 category (closed), but the refrigeration EVENT is still active and in the STATE 2 category. The machine was read 2 minutes after the door was closed (15:24), but before the refrigeration had dropped back to normal temperature.

EA101 indicates EVENT EGS which is defined as Door Open

EA102 indicates the EVENT took place on 24 June, 2002

EA103 indicates the EVENT took place at 14:30

EA104 indicates the EVENT has occurred for 52 minutes

EA201 indicates EVENT EGS which is defined as Door Open

EA202 indicates the EVENT has occurred 4 times since the last audit

EA203 indicates the EVENT has occurred 36 times since initialization

EA205 indicates that the EVENT EGS is currently inactive (the door is closed)

EA101 indicates EVENT EJJ which is defined as Refrigeration

EA102 indicates the EVENT took place on 24 June, 2002

EA103 indicates the EVENT took place at 15:50

EA104 indicates the EVENT has occurred for 34 minutes

EA201 indicates EVENT EJJ which is defined as Refrigeration

EA202 indicates the EVENT has occurred 1 time since the last audit

EA203 indicates the EVENT has occurred 2 times since initialization

EA205 indicates that the EVENT EGS is currently inactive (the door is closed)





DXS*XYZ1234567*VA*V0/6*1	Application header (Mandatory Header)
ST*001*0001	Transaction Set header (Mandatory Header)
ID1*ABC98765*****11223344	Identification data segment
VA1*1000*200	Vend Transaction data segment
VA3*50*1	Free Vend Transaction data segment
CA3*****1250*250*400*6	Cash In data segment
CA4***250*0	Cash Out data segment
PA1*1*50*****	Product 1 Information data segment
PA4*1	Product 1 Free Vend Transaction data segment
PA7*1*CA*0*50*72*3600*11*550	Product 1 Cash Transaction data segment
PA7*1*DA*1*50*756*37800*121*6050	Product 1 Cashless 1 Transaction data segment
PA7*1*DA*2*25*33*825*4*100	Product 1 Cashless 1 Transaction data segment
PA1*2*50****	Product 2 Information data segment
PA4*0	Product 2 Free Vend Transaction data segment
PA7*2*CA*0*50*40*2000*10*500	Product 2 Cash Transaction data segment
PA7*2*DA*1*50*600*30000*100*5000	Product 2 Cashless 1 Transaction data segment
PA7*2*DA*2*25*30*750*2*50	Product 2 Cashless 1 Transaction data segment
EA1*EGS*020624*1430*52	Event Timed Information
EA2*EGS*4*36**0	Event Information
EA1*EJJ*020624*1500*22	Event Timed Information
EA2*EJJ*1*2**1	Event Information
EA3*020624*1524*****24*10	Number of Reads Information
G85*1234	Record Integrity Check (Mandatory)
SE*19*0001	Transaction Set trailer (Mandatory Trailer)
DXE*1*1	Application trailer (Mandatory Trailer)



CHAPTER 3 - DATA TRANSFER USING ENHANCED DDCMP

A communications trace can be found in directory DDCMP Software available on the EVA website www.vending-europe.eu.

3.1 SCOPE

This chapter defines the Enhanced DDCMP, which is based on the previous (older) DDCMP Protocol

Implementation (EVA- DTS Version 4.1). Enhanced DDCMP specifies a method of transferring data either via an optical or a hardwire link within a vending environment.

The main features of EOP

Enhanced DDCMP are:

- Supports an optical bus for networking of more than one slave device.
- Defines a hardware implementation compatible with IrDA.
- Defines a protocol, based on the existing DDCMP implementation used in the vending industry that can transmit data securely.

The following pages specify how to establish an IrDA - hardware compatible link, (also possible as a direct connect link), to allow networking of more than one slave device at transmission rates up to 115200 baud, using an optical link.



With these additions, Enhanced DDCMP allows data transfer between a handheld computer and a cashless payment system. As the transmission rate may be incremented up to 115200 bps, the amount of data can be large enough for cashless payment systems as for future vending machines.

One of the most important features of Enhanced DDCMP is that it is compatible with the older DDCMP protocols used by the vending industry. Enhanced DDCMP shall be used for all new developments of product complying with this specification.

Chapter 6 contains some application notes to aid the practical implementation and support of the protocol as well as compatibility with the previous standard of DDCMP.

3.1.1 Terms

The terms defined below are used throughout the document.

Master	The device that initiates the DDCMP communications session.
Slave	The device that responds to the initial master communications.
Transmitting Station	The device that is sending data/command messages. This can swap between the slave and the master device during one DDCMP session.
Receiving Station	The device that is receiving data/command messages. This can swap between the slave and the master device during one DDCMP session.





3.2 INTERFACE OVERVIEW

Enhanced DDCMP defines a communications protocol for the interchange of data between two or more units: one unit is nominated as master while the other units are nominated as slaves.

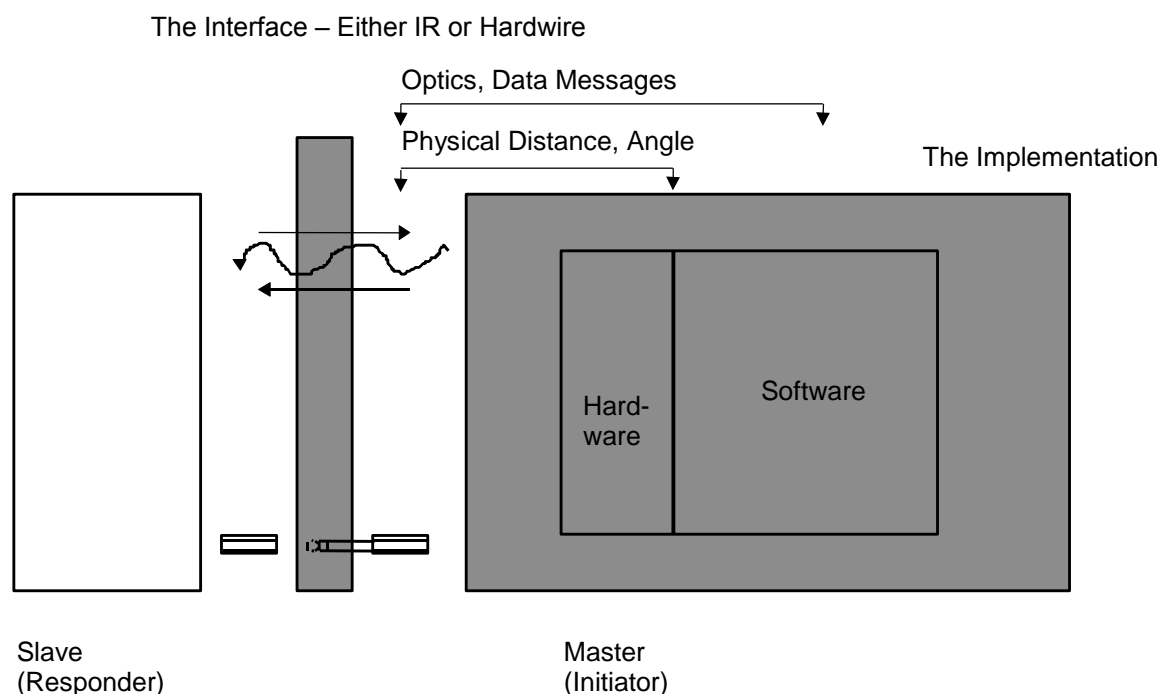

Figure 2: Coverage of the Specification (shaded areas)

(Please note that the hardware & software implementation in the slave is identical to that in the master.)

The master in any DDCMP session is the initiator of the session (in a standard set-up this will always be the Data Carrier). However, if the link is Direct Connect (as described in 7.3) then either end can initiate the session and hence be the master.

In order to avoid a communications error occurring if the Data Carrier and the Vending Machine initiate communications at the same time, the Data Carrier must take priority. Therefore, if the Vending Machine detects a comms error in the first START message, it must wait for a period of time equal to the STACK timeout x 2 (see Table 2) before trying to initiate the link again.

The communications can take place between different units as shown in the following table, with the first two of these pairs being the most common.





Table 1: Example of Communicating Units

Slave	Master	Recommended Connection
Vending Machine	Data Carrier	Optical
Cashless Payment System	Data Carrier	Optical
Audit Databox System	Data Carrier	Optical
Data Carrier	Computer	Direct Connect / Optical (point to point)
Vending Machine	Computer	Direct Connect / Optical (point to point)
Data Carrier	Data Carrier	Direct Connect / Optical (point to point)

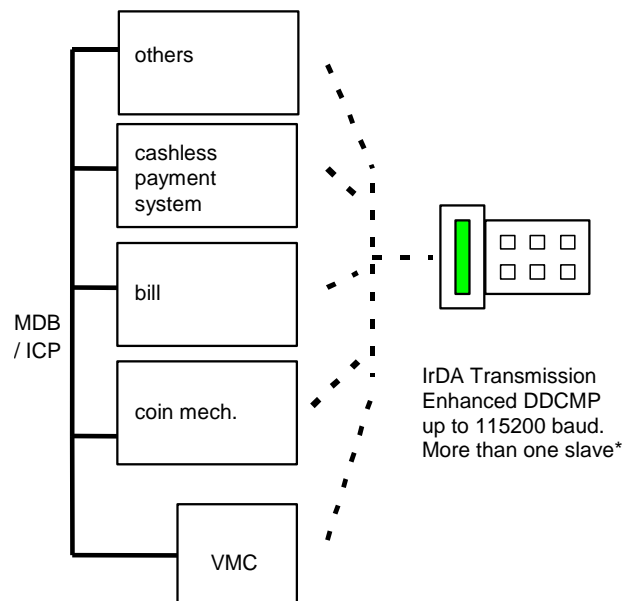

Within the Vending Machine, it is possible that any one of a number of electronic units will communicate with a Data Carrier, as shown in Figure 2a, either all at once* or one after another. The presently established units being a Coin Mechanism, a Card Unit, an audit Databox and the VMC.

Figure 2a: Enhanced DDCMP: Optical Bus configuration

* Note: To read all devices at once, each peripheral has to have its own individual address set and the handheld needs to know these addresses beforehand. In this case, once the read has been instigated by the user, each device is then read in turn and the data stored separately within the handheld.

The interchange of data will normally be bi-directional, with the master sending control and command messages to the slaves which will normally reply by transmitting its stored data.





The protocol is organised into five levels as follows:

Level	Contents	Section	Name
5	Required Functions + Data	3.7	Communications Session
4	Control Info, Message Info Order of transmit & receive Command Messages Data Messages	3.6	Application Level Details
3	ACK/NACK+START/STACK Error handling	3.5	Session Level Details
2	Cyclic Redundancy Check Character Sequence (Frame) Baud Rate, Start & Stop bits	3.4	Datalink Level
1	Optical Modulation / Connector	7.4	Physical Level Details

By viewing the communications as a layered protocol, it is intended to aid the implementation by dividing the tasks to be accomplished into easily achievable & testable segments.

Most sections can be read stand alone, however they should be read in sequence, either forward (lowest level first) or reverse (highest level first).



3.2.1 General Data Transfer Operation

Before communications can be started, the devices must be 'connected' either optically, by placing the master's optical Tx/Rx unit within 1 metre of the slaves', or directly, using the jack plug and socket.

Once the slave device is idle (i.e. not executing any function) it will automatically respond to communications activity from the master device. The master device initiates a communications session by sending a 'start' command. Thereafter, until the master device sends a 'finish' command to terminate the communication session, the slave device will obey any command it receives provided the slave's address matches the masters requesting address.

If any abnormalities are detected in the communications such that it is not possible to carry on with the sequence of commands, the master device can re-initialise the communications link. The slave device will abort whatever it was doing and revert to waiting for a command. (See application note 6.2.2.5)

As a safeguard against communications link malfunction, the slave devices will automatically terminate communications if there has been no communications activity for a specified timeout. (Receive data message/link time-out, see table 2).

If the master device wishes to keep the communications link active then it should send commands within the Receive data message/link time-out of each other. One of the commands - 'WhoAreYou' - can be used to keep the link alive, assuming there are no other actions the master device wishes to perform.

The automatic communications start-up means that slaves can be left unattended at a remote site (e.g. if connected via a modem and the telephone system). If long delays occur, e.g. if re-dialling after losing a telephone connection, the Master can simply re-start communications without any manual intervention.

3.3 PHYSICAL LEVEL DETAILS

Please refer to chapter 7 for details of the IrDA and direct connect physical layers.

The optical Link is IrDA-1.0 compatible at the physical layer only. For more detailed information refer to the IrDA Physical Signaling Layer Specification, which can be found on the IrDA web site, Uwww.irda.orgU.





3.4 DATALINK LEVEL

The Datalink Message Level provides a means of communicating a data message, without error, between at least two stations on a communications link.

The protocol used is loosely based on a sub-set of the DEC Data Communications Message Protocol (DDCMP) designed by Digital Equipment Corporation. It is also an extension to the EVA-DTS DDCMP implementation as described in version 4.1. The reader may wish to refer to the DDCMP Specification document number AA-DS99A-TC for details of the original protocol.

It is the intention of this specification to contain sufficient information to allow an implementer to proceed without reference to the formal DDCMP specification. The DDCMP functions implemented are :

Initialise link.

Transmit data message.

Receive data message.

The Datalink level is the lower 'layer' of the Enhanced DDCMP implementation. As such it deals principally with four items :

- Initialisation & message counting (START,STACK + ACK,NACK).
- Cyclic Redundancy Check.
- Character Sequencing (framing).
- Error Handling.





3.4.1 Data Format

› 3.4.1.1 Optical Bit Format

A binary low (start bit) is defined as the presence of one pulse of optical energy at the source (carrier and subcarrier), starting with the beginning of the binary low (

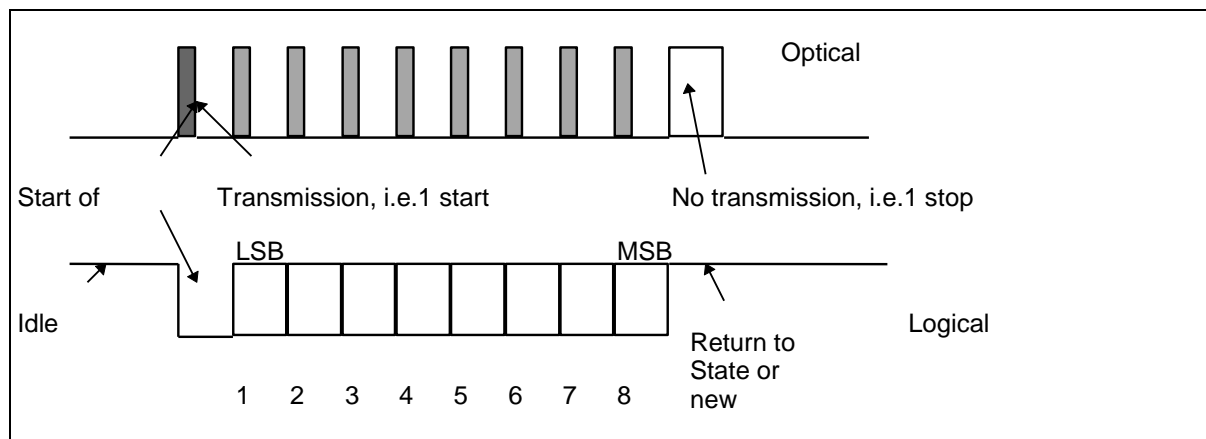

stop bit) is defined as the absence of any transmitted optical energy from the source.

Figure 4: Asynchronous Data Format



› 3.4.1.2 Byte Format

10 bits / byte, consisting of one start bit, 8 data bits, and one stop bit. The data bits are transmitted least significant bit first (after start bit) and most significant bit last (before stop bit). There are no general restrictions as to data values.

3.4.2 Basic Transmission Parameters

The communications link can handle, in half duplex mode, transmission and reception of any 8 bit character combination

Standard starting Rate: 2400 Baud

Maximum high speed Rate: 115200 Baud

The actual baud rate used will be the lowest common baud rate supported by the 2 link nodes.

› 3.4.2.1 Synchronisation

3.4.2.2.1 Bit Sync

Intrinsic to link receiver circuits, with a maximum timing skew of up to 25% of the bit width in any bit of a transmitted character no error on reception should be caused.

3.4.2.2.2 Byte Sync

Asynchronous with start bit & stop bit framing.



3.4.2.2.3 Transmission Sync

During start and start acknowledge sequence, some bytes of the START and STACK messages are used to define the master's baud rate and the slave's baud rate capability. If a new baud rate is necessary, an additional START and STACK message sequence is required at the new baud rate to establish the new rate.

See control messages (section 3.6.2) for details.

NOTE 1: An example of changing speed characteristics is detailed in the application notes section (6.2.1.1).

NOTE 2: If older peripherals are to be supported for compatibility reasons, refer to EVA-DTS 4.1 for start-up sequence.

3.4.2.2.4 Message Sync

Message framing shall be dependent on detection of specific bytes within the message to define the start and length of each message in the case of variable length messages. Alternatively, in the case of fixed length messages, the message framing shall be in accordance with this specification and may be determined during a sequence of messages by reference to the message type or number within the sequence.

Message framing is done in two different ways:

- Fixed length messages have a specific format, as detailed below in the specification.
- Variable length messages: Length data is always passed in bytes 2 and 3 of the data message header.



3.4.3 Message Framing

The Enhanced DDCMP's fundamental unit of transmission is a collection of characters, or 'frames'. In the majority of frames the first character implies exactly how many characters are expected to be received in the frame being transmitted. In the case of some data messages the first character implies a variable length frame and a subsequent character (usually the second or third) either implies or defines, dependent on the message, exactly how long this frame being transmitted actually is.

As would be expected, there are lower level communications modules which deal with transmitting each character within the frame, and each bit within the character. These are not usually regarded as forming part of the Enhanced DDCMP modules.

The purpose of framing is to provide a robust communications channel which is resistant to errors and capable of 'clean' recovery when errors do occur.



3.4.4 Data Length Restrictions

The implementation of the Enhanced DDCMP link assumes a multiple point-to-point half duplex communications link i.e. transmission in one direction at a time. In this implementation one message is sent at a time, awaiting an acknowledgement before a further message is sent: i.e. no pipe-lining is handled. Data messages are restricted in length as follows:

from master to slave:

Blocks up to 16383 bytes, subject to slave buffer size, comprised of:

- 8 bytes for an ACK to a pre-sent transmitted message.
- 8 bytes for message header.
- 2 bytes for message data block ID and message number.
- up to 16365 bytes as data.
- 2 bytes for data CRC.
- to a maximum data file length of 64k bytes (the Enhanced DDCMP limit) & then a new data message is needed, or
- to an unlimited data file length, using the select flag mechanism to transmit data messages of unknown length.

from slave to master:

Blocks up to 16383 bytes, subject to transmit buffer size which is implementation specific, comprised of:

- 8 bytes for an ACK to a pre-sent transmitted message.
- 8 bytes for message header.
- 2 bytes for message data block ID and message number.
- up to 16365 bytes as data.
- 2 bytes for data CRC.
- to a maximum data file length of 64k bytes (the Enhanced DDCMP limit),or
- to an unlimited data file length, using the select flag mechanism to transmit data messages of unknown length.

The recommended default buffer length is 256 bytes throughout the system. Alternate slave buffer lengths are to be explicitly communicated using the 'Who Are You' command/response sequence.



3.4.5 Cyclic Redundancy Check

All messages have a fixed length header (6 bytes) followed by two CRC-16 check bytes. Message framing by the receiving end is achieved when the header, starting with one of three possible byte values, is received with a valid CRC-16 check.

The type of message is indicated by the first, and sometimes the second byte, in the header. All Control Messages consist of just the header. Data Messages consist of the header which specifies the length (in bytes) of all of the data, followed by the current data block. Two CRC-16 check bytes follow the data block. These apply to the data bytes only.

The CRC-16 algorithm used is:

$$p(x) = x^{16} + x^{15} + x^2 + x^0$$

Examples of how to code this in C and Assembler are shown in Section 6.1.2.





3.4.6 Datalink Timings/Restrictions

Maximum START attempts	10
STACK time-out period	250 ms
Maximum data transfer attempts	5
Received data message/link time-out	5 seconds
Received data message/link time-out in connection with READ /WRITE DATA or PROGRAM SLAVE DEVICE command	15 seconds
ACK time-out period	170 ms
Inter-character time-out	65 ms
Idle condition	
Minimum turn around time in the receiver	40ms
Rx to Tx Delay (See 3.7.3)	
Maximum turn around time in the transmitter	4ms
Tx to Rx Delay (See 3.7.3)	

Table 2: Link time-outs and restrictions





3.5 SESSION LEVEL

3.5.1 Initialization & Maintenance

There are two parts to low level synchronisation, firstly initialising the link and secondly keeping the link going.

Low level initialisation is achieved by the master transmitting a START control message at a standard rate of 2400 baud.

The slave station should respond with a STACK (STart ACKnowledge) control message, whenever its slave address matches the requested address.

A second START/STACK pair will be exchanged, at a new baud rate, if baud rates are changed (i.e. slave agrees to speed suggested by master).

Data may then be passed between the stations by enclosing it in a data message for transfer across the communications link. Each data message transmitted by a station will require an ACK control message to be transmitted by the other station when it has successfully received the data message. Non-arrival of the ACK within the specified time period (ACK time out period, table 2) will indicate to the transmitting station that the transmission was not successful or there was no slave with such an address and will be treated similar to a NACK. (See application note 6.2.2.3).

Enhanced DDCMP incorporates a NACK control message to allow a speedier indication of certain error conditions such as corrupt data. If error conditions occur, the transmitting station will re-attempt the transfer a number of times before finally giving up (Maximum data transfer attempts, table 2). (See application note 6.2.2.4).



› 3.5.1.1 Data Message Sequence Number Checking

Each station must maintain two message sequence numbers:

- Transmit Number - the number of the current message being transmitted.
- Receive Number - the number of the current message being received.

Successful transmission of a message occurs when the number in the message (the Transmit Number in the transmitting station) is the same as the Receive Number in the receiving station.

The use of data message sequence numbers allows the possibility for a data message to be used as an ACK to a data message sent in the previous direction. This is referred to as the 'piggy-back ACK' mechanism and allows a reduction in the protocol overhead on a busy half-duplex communications link.

This feature of the sequence number mechanism handles the case where an ACK control message is not successfully received. In such a case the transmitting station will re-transmit the original message. The receiving station will see a sequence error so send a NACK. The effect is that the original transmitting station will see a matching sequence number in the response and so assume that the message transfer was successful. (See application note 6.2.2.6).

Note that if the data message transfer has failed (Max data transfer attempts reached) and the receiving station does not respond to any attempts to reinitialise the link, then the transmitting station should give up and indicate that an error has occurred.

Note 1: The message sequence number mechanism described here is a much-simplified form of that available in a full DDCMP implementation. This is because, unlike the full implementation in which a single ACK will serve to acknowledge a sequence of data messages, each data message will be acknowledged individually.

Note 2: Message numbering should always start with 1.



3.5.2 Error Handling

The Datalink level exists to overcome errors on a communications link. If the link was not subject to errors then there would be no need for the protocol level. Error handling is, therefore, an inherent part of the protocol and has been included in the rules for data transfer described further below. The current section serves to amplify some points concerning the detection of and recovery from errors.

› 3.5.2.1 Error And Abnormal Conditions

All messages incorporate redundancy checks i.e. CRC's to allow detection of corrupted data. Data messages are assigned sequence numbers to allow detection of lost or repeated messages.

An error or abnormal condition exists when one of the following occurs:

- A message does not arrive within a specified time
- A message contains an unexpected slave address
- A message is corrupted (its contents do not match the redundancy check value)
- Data message sequence numbers do not match
- Data message is too long for the receiving station to handle.
- A START message is received during a message transfer sequence.
- An unexpected type of message arrives, e.g. an ACK instead of a data message.
- The station address is invalid.

It is also possible for incomplete messages to be received. In this case, the assumption is that receive overrun has occurred causing loss of characters. This is regarded as a corrupt data condition rather than a receive time-out.



› 3.5.2.2 Recovery

When an error or abnormal condition occurs it is important for the receiving station to maintain synchronisation or re-establish synchronisation with the transmitting station. If the message is not corrupt then, ideally, the receiving station should be able to continue to the end of the message (if not already there). If the message is corrupt:

- The receiving station scans the character stream looking for the sequence that identifies a new message – at the current baud rate.
- The transmitting station waits for idle (no communication activity), before attempting to send next message – at the current baud rate.

The main classes of recovery action are:

1. Immediate termination of the transfer attempt if:

- Receiving station does not receive message within specified time period (Received data message/link time-out, table 2).
- START message received (at the current baud rate).

2. Receiving station sends a NACK control message and waits for retransmission of the data message if:

- corrupt data.
- data message sequence number mismatch.
- data too long for buffer.
- buffer temporarily unavailable.

3. Transmitting station re-transmits the data message if:

- no acknowledgement (within ACK timeout, table 2).
- corrupt acknowledgement.
- ACK with out-of-sequence message numbers.
- NACK received with out-of-sequence message numbers.

4. Receiving station waits for re-transmission of the data message if:

- Any other error or abnormal condition occurs





If the recovery action requires a re-attempt of a data message transfer then this is not attempted if the maximum number of attempts has already been reached. At that point either or both stations will assume that there has been a total communications failure. The link will require re-initialisation before data messages can be transferred again.

A total breakdown of communications could lead to one station still awaiting a data message when the other decides to re-initialise the link. The receipt of a START message at any time must cause the receiving station to abort its function and re-initialise the communications link. (See application note 6.2.2.5).

Note, timings referred to in table 2 relate to the end of the data command message to the end of the ACK/NACK or data message header as shown in the example below.

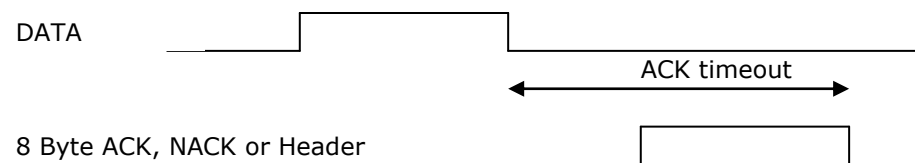



3.6 APPLICATION LEVEL DETAILS

3.6.1 Message Types

Control and Data Messages may be distinguished by the first character (Hex representation) in the message string:

'05' - Indicates a Control Message

'81' - Indicates a Data Message

Within Data Messages, there is another level of differentiation, as indicated by the first character of the Data Block following the Data Message Header:

'77' - Indicates a Command Message

'88' - Indicates a Command Message Response

'99' - Indicates a Data Block





The various message types are listed below :

Control Messages

Start	("START")
Start Acknowledge	("STACK")
Acknowledge	("ACK")
No Acknowledge	("NACK")

Data Messages

Command Messages*

Hex Designators

Who Are You	77 + E0
Program Slave Device	77 + E1
Read Data**	77 + E2
Write Data**	77 + E3
Delete Data	77 + E4
Program Module	77 + E5
Read Memory	77 + E6
Finish Communications	77 + FF

Command Responses*

Who Are You – Accepted / Rejected	88 + E0
Program Slave Device - Accepted / Rejected	88 + E1
Read Data – Accepted / Rejected	88 + E2
Write Data – Accepted / Rejected	88 + E3
Delete Data – Accepted / Rejected	88 + E4





	Program Module – Accepted / Rejected	88 + E5
	Read Memory – Accepted / Rejected	88 + E6
Application Data Messages*		
	Data Blocks	99 +

* - These items are treated as an enhanced DDCMP data message, i.e. contains a CRC suffix and is preceded by a Data Message Header with its own CRC suffix.

** - used to read and write EVA-DTS reports.

› 3.6.1.1 Message Format

Control Message 8 Bytes header only (including 2 byte CRC)

Data Message 8 Bytes header (including 2 byte CRC) + Variable length data field.

The Data Message Protocol sends Control, Command and Data Block messages in two fundamental forms. The first of these applies solely to Control Messages, all of which are sent exactly as shown in a subsequent section in this chapter. The second form applies to all other forms of message, which in strict Enhanced DDCMP terms are treated as Data Messages, and are all prefixed by the same Data Message Header.





› 3.6.1.2 DDCMP List numbers

The list number principle is only supported by the DDCMP and Enhanced DDCMP protocols. List numbers are used by the Read and Write Data DDCMP messages to specify the type of read or write that is being carried out. The following list numbers have been defined:

No.	List Name	List Meaning
1	Audit Collection List	Standard audit data only.
2	Security Read List	Standard audit data is read without resetting the interim data. (Read only)
50	Default Overall Dump List	All data (configuration and audit) contained in the control board.
64	Machine Configuration List	Control board configuration data e.g. space to sales data.

Further information on the use and meaning of these lists can be found in section 6.2 of this document.





3.6.2 Control Messages

The following Control Messages may be sent on their own:

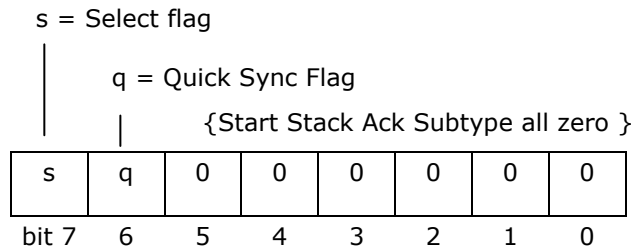

START	05	06	40	00	mbd	sadd	CRC16 (ls)	CRC16 (ms)
-------	----	----	----	----	-----	------	------------	------------

STACK	05	07	40	sbd	mbd	sadd	CRC16 (ls)	CRC16 (ms)
-------	----	----	----	-----	-----	------	------------	------------

ACK	05	01	40	rr	00	sadd	CRC16 (ls)	CRC16 (ms)
-----	----	----	----	----	----	------	------------	------------

NACK	05	02	40	rr	00	sadd	CRC16 (ls)	CRC16 (ms)
------	----	----	----	----	----	------	------------	------------

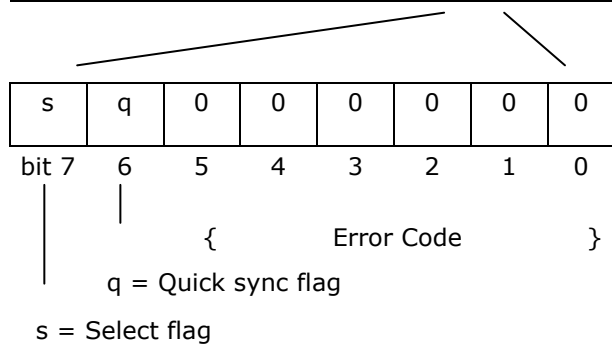



Where definitions are :

mbd / mbr	<p>N.B.If this value is not zero, the master requests further communication at a different baud rate.00 = baud rate remains unchanged</p> <p>(01 = 1200 baud not recommended for IrDA-links)</p> <p>02 = 2400 baud</p> <p>03 = 4800 baud</p> <p>04 = 9600 baud</p> <p>05 = 19200 baud</p> <p>06 = 38400 baud</p> <p>07 = 57600 baud</p> <p>08 = 115200 baud</p> <p>On STACK frame mbr is a copy of mbr from previous START if supported, otherwise the maximum supported rate.</p>
sadd	Station address, the address of the master requested device as defined in table 4.
sbd / sbr	<p>The slave's capable baud rate to communicate</p> <p>00 = default slave, the master isn't allowed to change baud rate from the actual established link, so stay within EVA-Enhanced DDCMP (or EVA-DDCMP version 4.1, if appropriate).</p> <p>01 - 08 see mbr. Master and Slave choose for further communication the minimum value of sbr and mbr.</p>



Table 3 Abbreviations

Within the Control Message, each byte has a different function:

Byte No	Meaning
1	Always 05, indicates start of control message
2	01 to 07, defines the type of control message
3	The most significant 2 bits are the Select Flag and the Quick Sync Flag. The Select Flag is used to alter the selection of which side of the link is master and which is slave. In the Enhanced DDCMP link this flag is always reset to zero, i.e. the Interrogating Station is the Master.

The Quick Sync flag is only used for synchronous comms links and can reduce the time taken to resynchronise the link. It indicates that the next message will not about this message and thus for an asynchronous link, where this condition always exists, the flag is set to 1.

not used: always set to 1

The least significant six bits for the START, STACK, and ACK messages are the subtype of the message, i.e. a potential extension to byte #2, and are not used. They are always reset to 0.

For the NACK message, the least significant 6 bits represent the error code and have the following range of values:

A. Error usually due to transmission medium:

1 = header block check error - i.e. CRC16 error in either a Control Message Header or a Data Message Header.

2 = Data field block check error - i.e. CRC16 error in either a Command Message / Response or a Data Message.

3 = REP response – this is not used in the Enhanced DDCMP Communications link.

B. Error usually due to computer / interface

8 = buffer temporarily unavailable

9 = receive overrun



- 16 = message too long
- 17 = message header format error
- 4 The number of the last Control Message or Data Message received ok. This is always reset to 0 by a START message and is also used as the slave's transmission rate indicator in the corresponding STACK. Thereafter the number increments for each Data Message Header transmitted i.e. if no data message has been received or transmitted the count is 0. It is used as a check on message synchronisation by the Master. (see application note 6.2.1.1)
- 5 This is a 'fill byte' and is always reset to 0, whereas during start/stack, it is used to identify the masters requesting transmission rate
- 6 The Station Address field or Network Node, always set to 1 in point to point old DDCMP communications (broadcast request). All values except 1 indicate the slave must check the requested address matches it's own before it responds.
- 7,8 CRC 16 Code for block check error detection.

› 3.6.2.1 Predefined Address Values

Using standard DDCMP:

In the older links, the value of sadd is always 0x01. In EVA V4.1, each transaction contains sadd = 0x01 and establishes a point to point connection, so each device answers to a 0x01 request. Therefore, for compatibility with that revision, each slave has to answer to 0x01 address.

Using Enhanced DDCMP:

If sadd is different from 0x01, it signals an addressed connection and only the slave with the matching address will answer.

N.B. A higher baud rate can still be negotiated with the slave device, even if it has a default address of 0x01, as long as it indicates it can support higher baud rates i.e. sbd > 0.

Table 4 defines a set of addresses either reserved or defined by this standard. The address of a device should default to the value shown, but the device must be capable of being manually altered to avoid any device clashes.





Device	Sub-Device	address
reserved		0x00
point to point (V4.1)	All	0x01
	individual reserved addresses	0x02..0x1f
Default COINMECH		0x02
Default CASHLESS SYSTEM		0x03
Default BILL VALIDATOR		0x04
Default AUDIT MODULE		0x05
Default PUBLIC CASHLESS SYSTEM		0x06
Default vending machine		0x07
		0x08
		0x09
		0x0a
		0x0b
		0x0c
		0x0d
		0x0e
		0x0f
	VMC	0x10
	VMC	0x11
	VMC	0x12





Device	Sub-Device	address
	VMC	0x13
	VMC	0x14
	VMC	0x15
	VMC	0x16
	VMC	0x17
	VMC	0x18
	VMC	0x19
	VMC	0x1a
	VMC	0x1b
	VMC	0x1c
	VMC	0x1d
	VMC	0x1e
	VMC	0x1f
	individual free addresses	0x20..0xff

Table 4 – Allocated device addresses





3.6.3 Data Message Header

The following Data Message Header will always be sent just before the Data Message to which it refers:

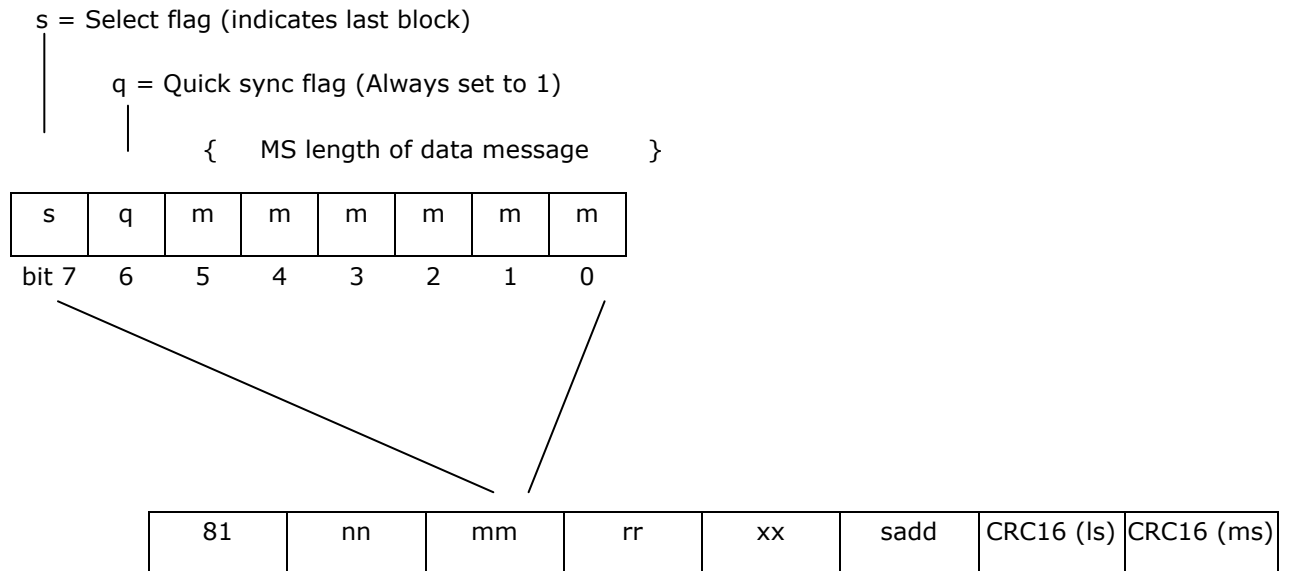

- mm = MS Length of Data Message
- nn = LS Length of Data Message
- rr = No. of last Rx OK (not data block)
- xx = No. of this Tx (not data block)



Within the Data Message Header, each byte has a different function:

Byte No	Meaning
1	Always 81, indicates start of data message header
2	LS length of the data message immediately following the header.
3	The most significant 2 bits are the Select Flag and the Quick Sync Flag. Select Flag is used to handle data transfers of data files of unknown length, set to 1 if last block being transmitted. Quick sync flag is always set to 1. The least significant six bits of the data message header are the ms length of the data message immediately following the header. Thus there are 14 bits (8+6) to indicate the block length. This forms the protocol limit for any one message.
4	The number of the last Control Message or Data Message received correctly. The number increments for each Data Message Header transmitted. It is used as a check on message synchronisation by the Master.
5	The number of this transmission, which is used in conjunction with the Rx ok byte to maintain message synchronisation.
6	The Station Address field or Network Node, as defined in table 4.
7	CRC16 LS Byte
8	CRC16 MS Byte



3.6.4 Data Messages

› 3.6.4.1 Command Messages & Responses

All of the messages in this sub section are preceded by a Data Message Header, as defined in section 3.6.3 of this document. In all of these messages, the CRC16 bytes are sent in LS Byte, MS Byte order.

3.6.4.1.1 Who Are You

COMMAND

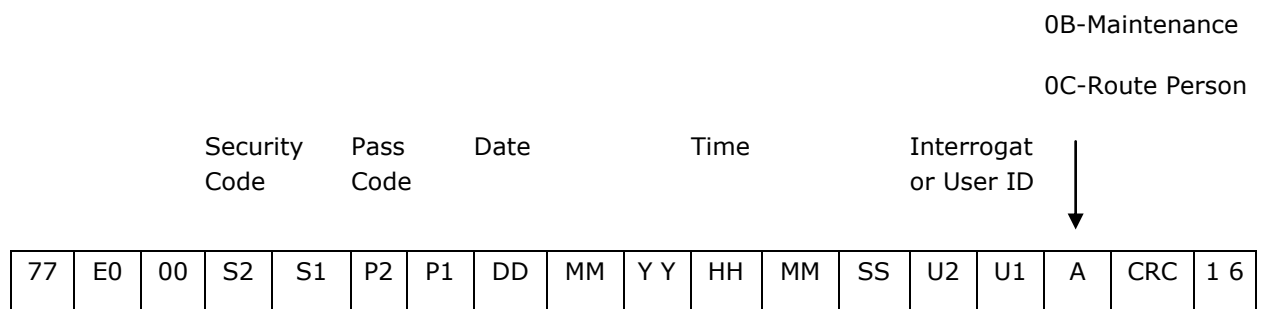

ACCEPTED RESPONSE

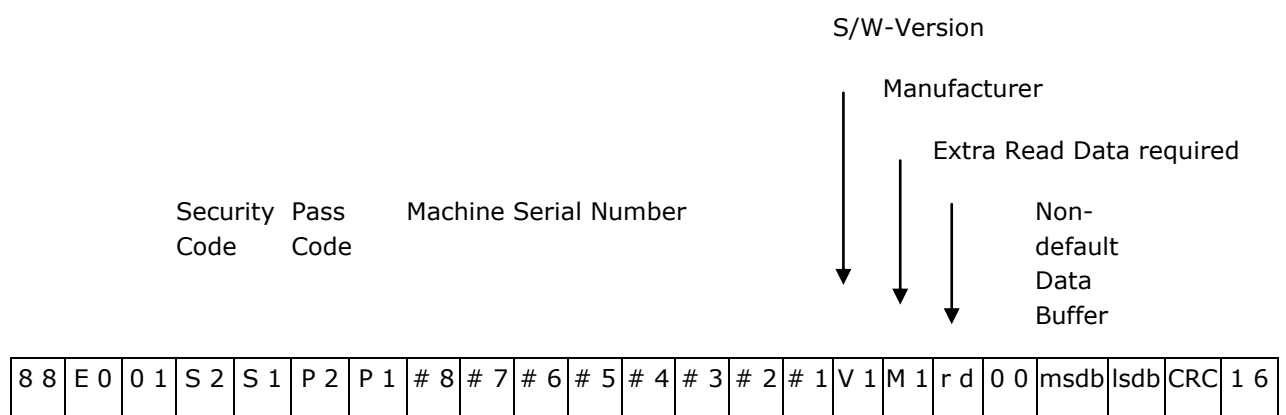

REJECTED RESPONSE

Denial Code = 01 - Security or Pass Codes do not match



8 8	E 0	0 0	0 1	CRC	1 6
-----	-----	-----	-----	-----	-----

Notes:

1. Machine Serial Number is ASCII.
2. Subscript digits are in increasing order of significance, i.e. #8 is most significant digit and #1 is least significant digit in Machine Serial Number.
3. This item is treated as an enhanced DDCMP data message, i.e. contains a CRC suffix and is preceded by a Data Message Header with its own CRC suffix.
4. Security Code & Pass Code are zero by default. Security and Passcode should be programmed, if the requesting device sends a non-zero value. (See application note 6.1.6).
5. Manufacturer Codes (ignored).
6. The RD value indicates the number of extra Read Data commands required to fully transfer the data i.e. if set to 1 there will be 1 extra read, if 2, there will be 2 etc.
7. The DB value (formed from msdb and lsdb) is to indicate the receive buffer size. A value of 0000H is the default buffer size of 256 bytes.
8. The date sent in this message is in BCD format. e.g. 20th June 2002 is 200602.





3.6.4.1.2 Program Slave Device

COMMAND

														OB-Maintenance																																					
														OC-Poute Person																																					
Security Code				Pass Code				Date				Time				Interrogator User ID		Machine Serial Number																																	
7	7	E	1	0	0	S	2	S	1	P	2	P	1	D	D	M	M	Y	Y	H	H	M	M	S	S	U	2	U	1	A	#	8	#	7	#	6	#	5	#	4	#	3	#	2	#	1	C	R	C	1	6

ACCEPTED RESPONSE

Security Code								Pass Code				Machine Serial Number																						
8	8	E	1	0	1	S	2	S	1	P	2	P	1	#	8	#	7	#	6	#	5	#	4	#	3	#	2	#	1	C	R	C	1	6

REJECTED RESPONSE

Sent if Security or Pass Codes do not match

8	8	E	1	0	0	C	R	C	1	6
---	---	---	---	---	---	---	---	---	---	---



Notes:

1. Machine Serial Number is ASCII, normally limited to digits 0-9.

2. Subscript digits are in increasing order of significance, i.e. #8 is most significant digit and #1 is least significant digit in Machine Serial Number

3. This item is treated as an enhanced DDCMP data message. i.e. contains a CRC suffix and is preceded by a Data Message Header with its own CRC suffix.

4. The date sent in this message is in BCD format.

3.6.4.1.3 Read Data

COMMAND

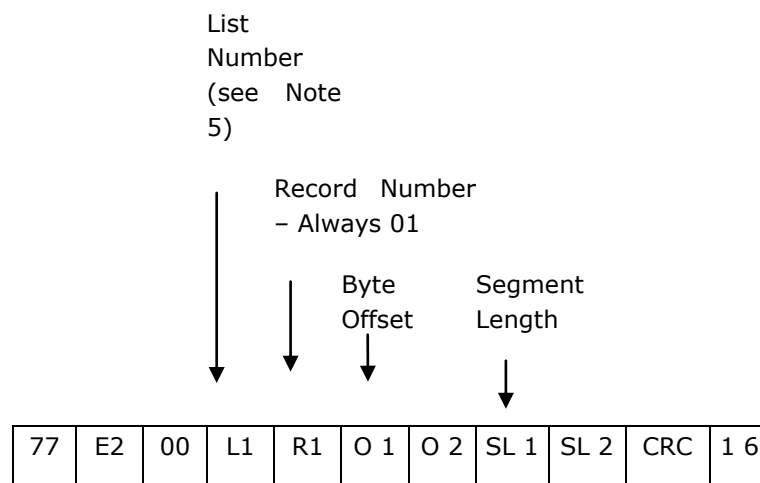



ACCEPTED RESPONSE

List
Number
(see Note
5)

Record Number
- Always 01

Byte
Offset

Segment
Length

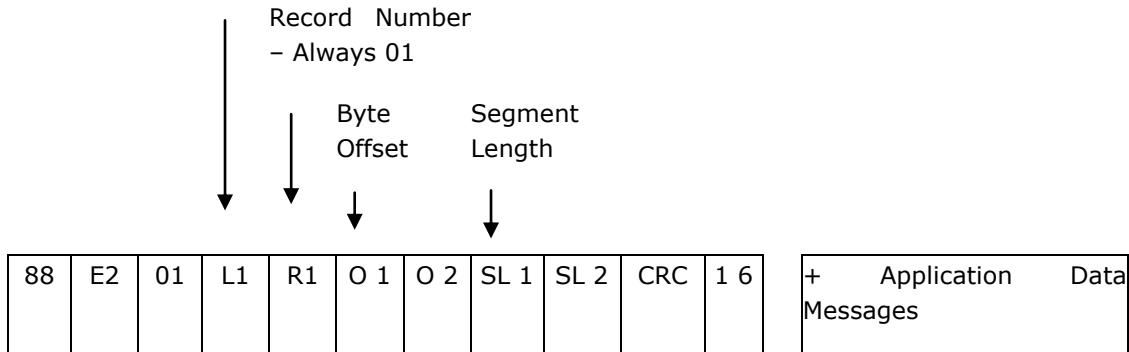

Record Length if SL in Command was Zero

REJECTED RESPONSE

Sent If No Record or if byte offset/segment length
exceeds record length

88	E2	00	CRC	16
----	----	----	-----	----



Notes:

1. Byte Offset & Segment length are set to Zero for the complete record. If non-zero then data of length <SL> is read from byte offset <O> from the start of the data.
2. The List Number corresponds to the collection of Records forming the list.
3. This item is treated as an enhanced DDCMP data message, i.e. contains a CRC suffix and is preceded by a Data Message Header with its own CRC suffix.
4. The Data Messages contain the data being read.
5. List Numbers are defined in section 3.6.1.2.
6. If the segment length in the ACCEPTED RESPONSE is FFFFH, the data file length is unknown and the end of transmission is signalled by setting the select flag. If this method is used, all blocks except the last one, are sent with select flag cleared. The last block is signalled by setting the select flag set. (See application note 6.2.1.9).





3.6.4.1.4 Write Data

COMMAND

List
Number
(see Note
4)

Segment
Length



77	E3	00	L1	SL 1	SL 2	CRC	1 6
----	----	----	----	------	------	-----	-----

+Application Data Messages

ACCEPTED RESPONSE

88	E3	01	CRC	1 6
----	----	----	-----	-----

REJECTED RESPONSE

Sent if Insufficient Space

8 8	E 3	0 0	CRC	1 6
-----	-----	-----	-----	-----



Notes:

- 1.The List Number corresponds to the collection of Records forming the list.
- 2.This item is treated as a enhanced DDCMP data message, i.e. contains a CRC suffix and is preceded by a Data Message Header with its own CRC suffix.
- 3.The Data Messages contain the data being written and are limited to 16365 bytes at a time.
- 4.List Numbers are defined in section 3.6.1.2.
- 5.If the segment length in the WRITE DATA COMMAND is FFFFH, the data file length is unknown and the end of transmission is signalled by setting the select flag. If this method is used, all blocks except the last one, are sent with select flag cleared. The last block is signalled by setting the select flag set. (See application note 6.2.1.9)





3.6.4.1.5 Delete Data

COMMAND

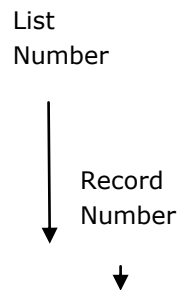

77	E4	00	L1	R1	CRC	1 6
----	----	----	----	----	-----	-----

ACCEPTED RESPONSE

88	E4	01	CRC	1 6
----	----	----	-----	-----

REJECTED RESPONSE

8 8	E 4	0 0	CRC	1 6
-----	-----	-----	-----	-----

Notes:

1.This message is mainly used by a PC to delete audit data temporarily stored on a handheld data carrier. It should not be used to delete data held in an audit storage device such as those contained within vending machines or coinmechs. (See application note 6.1.4.2)

2.This item is treated as a enhanced Protocol data message, i.e. contains a CRC suffix and is preceded by a Data Message Header with its own CRC suffix.





3.6.4.1.6 Program Module

COMMAND

Record Size

77	E5	00	RS 1	RS 2	CRC	16
----	----	----	------	------	-----	----

+Data Messages

ACCEPTED RESPONSE

88	E5	01	RS1	RS2	CRC	1 6
----	----	----	-----	-----	-----	-----

REJECTED RESPONSE

Error Code



8 8	E 5	0 0	E C	CRC	1 6
-----	-----	-----	-----	-----	-----

Notes:

- 1.This message is not used widely, but is used in some applications to update firmware in a slave device. It does not need to be implemented to read/write EVA/DTS audit data.
- 2.This item is treated as a Enhanced DDCMP data message, i.e. contains a CRC suffix and is preceded by a Data Message Header with its own CRC suffix.
- 3.If the segment length in the PROGRAM MODULE COMMAND is FFFFH, the data file length is unknown and the end of transmission is signalled by setting the select flag. If this method is used, all blocks except the last one, are sent with select flag cleared. The last block is signalled by setting the select flag set. (See application note 6.2.1.9)





3.6.4.1.7 Read Memory

COMMAND

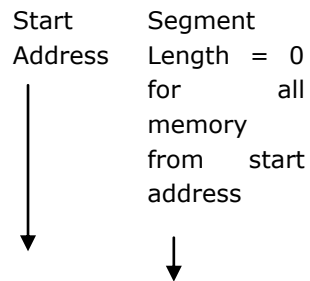

77	E6	00	SA 1	SA 2	SL 1	SL 2	CRC	16
----	----	----	------	------	------	------	-----	----

ACCEPTED RESPONSE

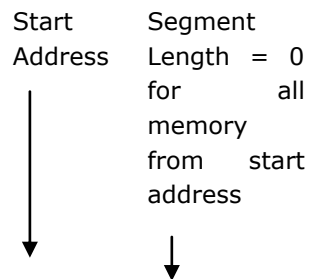

88	E6	01	SA 1	SA 2	SL 1	SL 2	CRC	16
----	----	----	------	------	------	------	-----	----

+ Application Data Messages

REJECTED RESPONSE

88	E6	00	CRC	16
----	----	----	-----	----



Notes:

1. Again, this message is not used widely, but is used in some applications to read the device memory to obtain device specific information, usually for the device developers. It does not need to be implemented to read/write EVA/DTS audit data.

2. Segment length is set to Zero for all memory from the Start Address.

3. This item is treated as an enhanced DDCMP data message, i.e. contains a CRC suffix and is preceded by a Data Message Header with its own CRC suffix.

4. The Data Messages contain the data being read.

5. If the segment length in the ACCEPTED RESPONSE is FFFFH, the data file length is unknown and the end of transmission is signalled, setting the select flag. If this method is used, all blocks except the last one, are sent with select flag cleared. The last block is signalled by setting the select flag set. (See application note 6.2.1.9)

3.6.4.1.8 Finish Communications

COMMAND

77	FF	CRC	16
----	----	-----	----

ACCEPTED RESPONSE

A NACK is sent

05	01	40	rr	00	sadd	CRC16	CRC16
----	----	----	----	----	------	-------	-------

REJECTED RESPONSE

a NACK is sent

05	02	40	rr	00	sadd	CRC16	CRC16
----	----	----	----	----	------	-------	-------



Notes:

1.If receiving station decides that operation (either collecting audit or writing data) was not successful then no response is sent. (See application note 6.1.5)

2.NACK only sent if error detected in transmission of FINISH command.

3.See section 3.6.2 for details on ACK and NACK messages.

› 3.6.4.2 Application data messages

The data file to be communicated can be thought of as a continuous string of bytes, independent of its content:



Maximum 64k Bytes or unlimited if select flag is used

This data file may then be split up into Data Blocks for communication in connection with the Read Data, Write Data etc. commands, building a user data message:

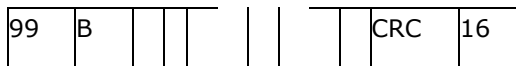

(more blocks if needed to send the data file)

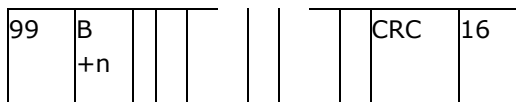
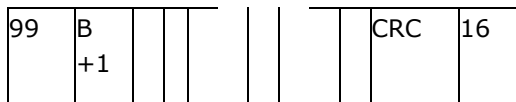

B is Block Number (First block is block 0)Data Bytes

Max. 16365 Bytes or less (see chapter 3.6.3)

Note: refer to 3.6.3. byte no 3

Each Data block is preceded by a message header, used to specify the block length. The data file length is given in the appropriate Read command, Write command, or by the select flag.



3.6.5 Message Sequence

There are three fundamental message sequences in general usage within the Enhanced DDCMP described in this document:

Audit Collection with optional Configuration

Program Slave Device with optional Configuration

Security Collection

All of these are described in the Application Notes section for DDCMP.

Please note that the message sequence examples in the Application Notes section show how a message sequence is most often composed, but the defined commands (Read Data, Write Data, Delete Data, etc.) are available and can be used in an arbitrary succession dependent on the purpose of the message sequence.





3.7 COMMUNICATIONS SESSION

The Communications Session is established and maintained with the sole purpose of communicating information from Master to Slave and vice versa.

Establishing the link is completed once the initial START - STACK message pair have passed between Master and Slave, if no baud rate change is requested. If the baud is necessary to change, an additional START-STACK pair is required while working within the baud rate.

Maintaining the link is accomplished at different levels within the communications software, by means of the relevant error correction features that the link provides.

Termination of the link is achieved by means of the master transmitting a FINISH command to the Slave and the Slave ACKnowledging that command.



› 3.7.2.1 Transmitting station

The user data is encapsulated in a data message and assigned the next transmit message sequence number (Message Tx Number = Internal Tx Number).

Transmit the data message and wait for acknowledgement.

IF an ACK control message, a NACK control message or a data message is received successfully and the response sequence number matches the one for the transmitted message (Message Rx Number = Tx Stn Transmit Number).

THEN Increment internal Tx Number (modulo 256). User software is informed of the successful transfer.

ELSEIF A corrupt message or an ACK/NACK/data message with non matching sequence numbers has been received.

THEN The data message is re-transmitted.

ELSEIF There has been no response within the ACK timeout period (table 2).

THEN The data message is re-transmitted.

ENDIF

(See application note 6.2.2.1 and Figure 5)

NOTE: If the transmitting station fails to transfer the message (i.e. Max data transfer attempts have been reached), it must still increment it's internal Tx number. This prevents the next transmitted message appearing to be the same as the previous (failed) one. However, most of the time this would lead to a sequence error being detected by the receiver (unless it happened to have received the previous message correctly despite the transmitter thinking it had failed) and the link would need to be re-initialised to synchronise the sequence numbers.

(See application note 6.2.2.4)





Process Flow for Transmitting Station

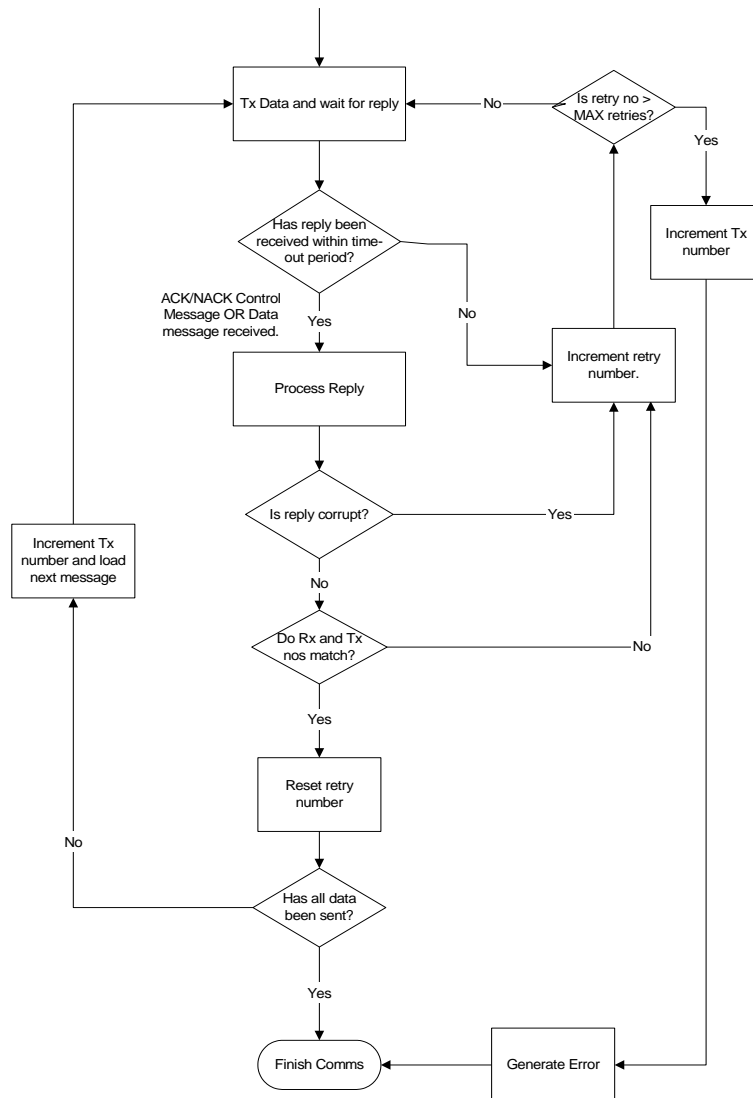

Figure 5: Transmitting Station Process Flow



› 3.7.2.2 Receiving Station

IF The data message is received successfully, i.e. the block checks are valid and the message Tx number is the same as the next one expected (Message Tx Number = Internal Rx Number)

THEN The Receive Number is incremented (modulo 256). An ACK control message containing the last received message sequence number is transmitted. The user software is informed of the successful receipt.

ELSEIF No data message is received within a pre-defined period (Received data message/link timeout, table 2).

THEN The user software is informed that there is no message.

ELSEIF The data message is received but it is corrupt, the message sequence number is not as expected or the data is too long for the receiver's buffer.

THEN a NACK control message containing the last successfully received message sequence number is transmitted.

ELSEIF a data message is received but it does not fulfil one of the above conditions

THEN The station ignores the message.

ENDIF

NOTE: If the transfer attempt fails and the maximum number of attempts has not been reached then the transfer is re-attempted. The receive data message time-out should be set long enough to allow for the maximum attempts by the transmitter (see table 2).





Process Flow for Receiving Station

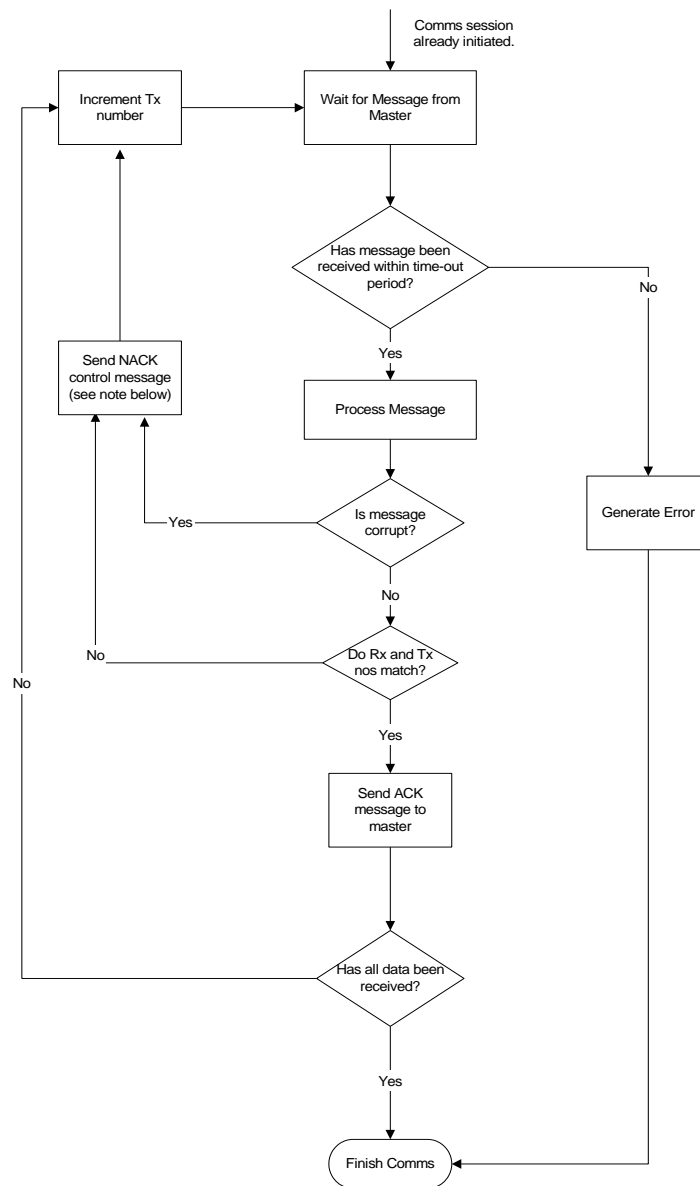

Figure 6: Receiving Station Process Flow



(See Note 1 - Because the link is asynchronous, if the slave responds with a NACK, the master may still send the next message causing collisions on the optical bus. If this occurs, the master will not receive the NACK, the slave will receive a corrupt message again, send a NACK and it could be possible to get into an infinite communications loop. Because of this, the slave device should send the NACK only once for each corrupt message sequence and remain silent thereafter. (See application note 6.2.2.3)

3.7.3 Turnaround Time

There are two turn around times appropriate to the Enhanced DDCMP communications link, dependent on the activity taking place, transmission or reception.

When a unit is transmitting it must ensure that on completion of a transmission it is ready to receive within the minimum time consistent with the hardware used. Likewise when a unit is receiving, it must allow a period of time after the end of the last reception to ensure that it does not transmit before the receivers at the other end are ready. These turnaround times are shown in table 2.





CHAPTER 4 - DATA TRANSFER USING DEX/UCS

A monitored communication can be found in directory DEX/UCS Software on this CD-Rom.

4.1 SCOPE

This specification defines a direct connect (electrically hardwired) communications interface for the interchange of data between two units in the vending environment. The interface / protocol is based on the DEX/UCS communications standard that was developed by the Uniform Code Council, Inc. and various sponsoring associations of the US grocery store industry.

The following Uniform Code Council (UCC) document **may be** obtained prior to implementing the direct connect vending system for more information and background on the UCC's implementation. This chapter of the EVA-DTS provides details of the system for the vending industry. The actual DEX/UCS protocol specification for the interface implementation is provided by the UCC document. It should be noted that the document provides more information than is required by the vending interface. This chapter will reference the pertinent sections which are applicable. See Section 4.8 for additional details.

The previous EVA-DTS, up to and including Version 5.0, referenced the original UCC document published in 1989 and titled:

Uniform Communications Standards for Direct Store Delivery – Implementation and User Guide (UCS/DSD-IUG)

This version of the EVA-DTS references the latest UCC document version **004010UCS** published in January, 1998 and titled:

UCS for Direct Store Delivery Implementation Guide (UCS/DSD)





It is available from:

Uniform Code Council, Inc.
7887 Washington Village Drive, Suite 300
Dayton, Ohio 45459

(937) 435-3870

(800) 543-8137 (USA only)

(937) 435-7317 (Fax)

www.uc-council.org

info@uc-council.org (E-mail)

4.2 INTERFACE OVERVIEW

The vending direct connect interface standard has been adapted from the DEX/UCS standard to directly link two electronic devices together for transferring vending audit or configuration data. Examples of vending audit data are the amount of cash accepted / dispensed, the amount and number of vend / product transactions, the number and/or times of events, etc. Examples of configuration data are setting prices, device asset numbers, time/date, etc.

The medium for the vending audit or configuration data transfer is based on the DEX/UCS fixed communications protocol and physical interface. The actual data records that are transferred follow the format of the DEX/UCS Delivery/Return Base Records; however, those records were intended for the US grocery industry. The details of the data records unique to the vending environment are found in the Data Dictionary (Appendix A) of the EVA Data Transfer Standard.

Throughout this chapter reference will be made to three specific types of electronic devices as defined below:

- Vending Machine Device (VMD) - refers to the actual device in the vending machine that monitors the various transactions and assimilates the audit data. This device may also be able to be configured using the DEX/UCS protocol. Examples of targets are vending machine control boards, coin mechanisms, cashless readers, audit devices, etc.
- Data Carrier (DC) - refers to the actual device that interrogates or configures the VMD using DEX/UCS. Examples are hand held terminals, portable computers, radio telemetry systems, cellular systems, etc.
- Business System Computer (BSC) - refers to the higher level computer system that the DCs upload with their collected data from the VMD or receive configuration/setup information. Examples are mainframes, minis, personal computers, etc. It should be noted that it is **not** a requirement that the DC to BSC interface be implemented via the standard DEX/UCS interface. Numerous proprietary and open means of transferring data between the DC and BSC exist worldwide in the industry.



The DEX/UCS communications protocol follows a four level (layer) approach similar in form to the International Standards Organization (ISO) "Open Systems Interconnection." The following subsections provide an overview of the DEX/UCS protocol starting with the lowest level of the four layers.

4.3 PHYSICAL LEVEL DETAILS

(Ref: **UCS/DSD Chapter VII Physical Level**)

Please refer to EVA-DTS Chapter 7.

Earlier versions of this specification allowed for some other method of initiating the DEX/UCS transfer in the VMD (i.e., a pushbutton) if automatic detect was not performed. It is the recommendation of NAMA and the EVA that for new designs after July, 2002, **no manual means of initiating an audit data transfer be permitted in a VMD**. This is especially important for unattended sites with remote access. In these cases, communications must be able to be started without manual intervention.

DEX transmissions must be able to be established with the vending machine door either open or closed. This is again especially true for unattended sites with remote access.

4.4 DATA LINK LEVEL DETAILS

(Ref: **UCS/DSD Chapter VII Data Link Level**)

(Ref: **UCS/DSD Appendix B**)

The details of the DEX/UCS Data Link Level are thoroughly defined in the UCS/DSD Chapter VII titled "DATA LINK LEVEL" and Appendix B titled "CRC GENERATION." The Data Link Level describes the actual serial communications parameters of the interface.

The implementation by the vending industry follows these sections explicitly and no further clarification is required.

Transmission Timing, Speed, and Format: The actual data communications is based on an asynchronous, half duplex serial interface operating with the characteristics of a 9600 bits per second transfer rate, eight bit bytes, no parity. The data bytes are based on the seven bit ASCII character set with the exception of the CRC-16 integrity bytes which use the full eight bits.

Allowable Characters: Except for the two byte block check CRC-16, all characters sent via DEX/UCS shall be the lower 127 ASCII characters (00h to 7Eh).



Specific control characters and combinations that are permitted are:

01h SOH	0Ah LF	10h 30h DLE 0 (ACK 0)
02h STX	0Dh CR	10h 31h DLE 1 (ACK 1)
03h ETX	10h DLE	10h 3Bh DLE ; (WACK)
04h EOT	15h NAK	
05h ENQ	16h SYN	
	17h ETB	

All printable characters (20h to 7Eh) are permitted for use in alphanumeric elements with the exception of an asterisk (*) which is used as a data element delimiter.

Flow Control: No hardware or software (XON/XOFF) flow control is provided.

Message transfer and blocking protocol: Message transfer control on a data block basis is provided by the procedures outlined in the Message Transfer Blocking Protocol section of the UCS/DSD Chapter VII which provides for blocking that is independent of message content.

Block Size: All data records are sent as variable length data blocks with an individual maximum size of **245** bytes. The (up to) 245 byte block is defined as that data following the **DLE STX** and continuing through and including the **DLE ETB** or **DLE ETX**. The CRC-16 is not included.

Block Cyclic Redundancy Check (CRC-16): The block CRC-16 is a 16-bit character generated by applying a specified algorithm to the contents of the transmission block. The CRC-16 is sent as two 8-bit bytes with the least significant byte sent first and the most significant byte sent second. In essence, if the CRC-16 had a value of 1234h, the block CRC would be sent as **34h 12h**. **Note that this is the opposite order that the G85 CRC is transmitted (see Chapter 2.4.3).**

The block CRC-16 is calculated starting with (and including) the first byte after the **STX** and ending with (and including) the **ETB** or **ETX**. Note that it will exclude any **DLE** or **SYN** control characters. For an explanation of the CRC-16 algorithm see Appendix B of the UCS/DSD Implementation Guide.





4.5 SESSION LEVEL DETAILS

(Ref: **UCS/DSD Chapter VII Session Level**)

The procedures for the establishment and termination of the communication session are based on the Establishment and Termination section of the UCS/DSD Chapter VII Session Level. This section defines the communications protocol where two directly connected devices (non-switched, point-to-point) may bid for master status. The ability to bid for master status provides the capability for transferring data in either direction between the two devices.

However, as of July, 2002, it is the recommendation of NAMA and the EVA that **all VMDs that are able to be configured** (i.e. vending machine control boards, coin mechanisms that hold prices, etc.) **do not bid** for master status except when reporting errors or other critical events. These VMDs should assume slave status at the initiation of the DEX transfer in order for the DC to direct the VMD as to whether audit information is to be read or configuration information is to be sent.

The details of the DEX/UCS Session Level are thoroughly defined in the UCS/DSD Chapter VII titled "SESSION LEVEL". The Session Level describes the three consecutive parts of the data transfer:

- **First Handshake** Session Level
- **Second Handshake** Session Level
- **Data Record Transfer** Session & Application Level

The following subsections are provided to highlight exceptions and provide further clarification for the vending industry.





4.5.1 Vending Machine Session Establishment

Prior to the three sessions occurring, the physical direct connection and the establishment of which device assume MASTER status must occur. MASTER status implies which device starts the first Handshake.

The interrogation of the VMD by the Data Carrier (DC) falls into the category of an unattended interchange (reference UCS/DSD Chapter VII Session Level Establishment and Termination section, "Contention for Master Status"). Although the DC plugs into or electrically connects to the VMD, the vending industry initially made an **exception** to the DEX/UCS specification and elected to have the VMD assume MASTER status for the First Handshake. This has been done for all current production coin mechanisms and most pre Multi-Drop Bus (MDB) vending machine controllers.

Most current generation vending machines controllers (primarily, but not limited to Multi-Drop Bus (MDB) controllers) assume the SLAVE status for the First Handshake. This has been done to allow the DC, as MASTER, to select the direction of data transfer to either retrieve audit data or transfer configuration/setup parameters.

With the introduction of real time telemetry systems, it has become optional for vending machine controllers to initiate a data transfer when an error or some other unique event occurs. This will allow the telemetry system to "immediately" notify the host system regarding the abnormal situation. The method for doing this will be for the vending machine controller to assume MASTER status for the First Handshake. Once the session is established, the controller will transfer the EA1 and/or EA2 event based data elements. It is up to the system design of the telemetry system to process the data further.

The two types of VMD session establishment place a requirement on the DCs to determine if it will become a MASTER or SLAVE for the First Handshake per below:

The DC, when connecting to a MASTER status VMD must allow for the first ENQs to be transmitted automatically from the VMD. Assuming the DC is capable of full-duplex communications, receipt of the VMD's ENQ prior to its ENQ transmission should result in the DC aborting its transmission and becoming an instant SLAVE. Otherwise, if the DC transmits its ENQ prior to or simultaneously with the VMD's, the VMD may miss the ENQ if half-duplex or throw it away if full-duplex. Regardless, the VMD will retransmit another ENQ and await the required DLE 0 (ACK 0) response. The DC, upon receiving the VMD's second ENQ should revert back to SLAVE status and continue with the First Handshake.

Following the physical connection and master/slave establishment, the actual three part data transmission will occur. This data interchange will adhere to the definitions of the referenced DEX/UCS documents.



4.5.2 Business System Computer Session Establishment

If the business system computer transfers audit / configuration data via the DEX/UCS protocol, when a DC plugs into a business system computer, the DC assumes MASTER status of the First Handshake. The business computer will therefore be the SLAVE.

Following the physical connection and master/slave establishment, the actual three part data transmission will occur. This data interchange will adhere to the definitions of the referenced DEX/UCS documents.

4.5.3 Session Establishment Formats

The following two examples show the First and Second Handshake formats used when the:

DC is the First Handshake master and the VMD is the slave

VMD is the First Handshake master and the DC is the slave

Note that the Second Handshake always reverses the master / slave role.

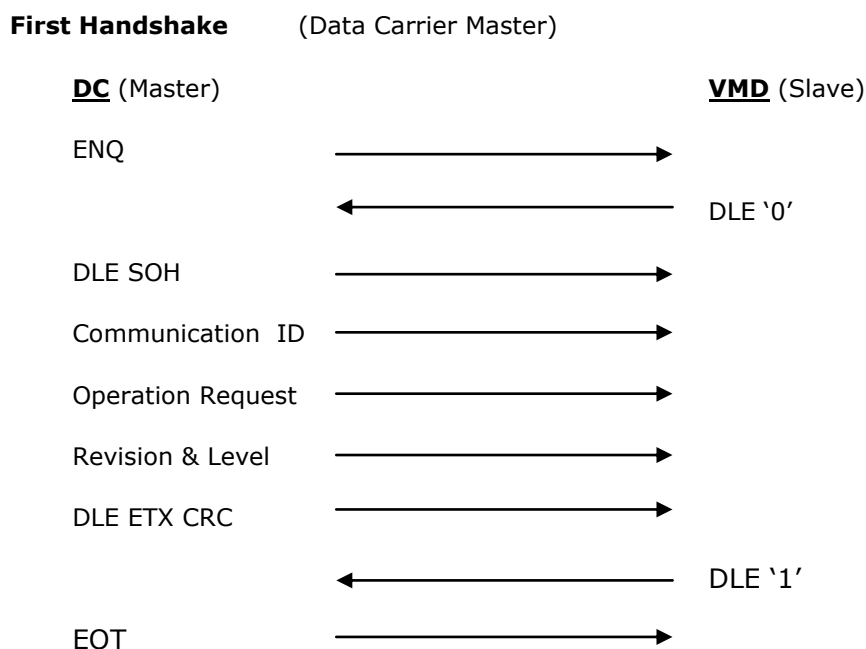

The CRC starts with the Comm ID and ends with the ETX, excluding the DLE

Second Handshake

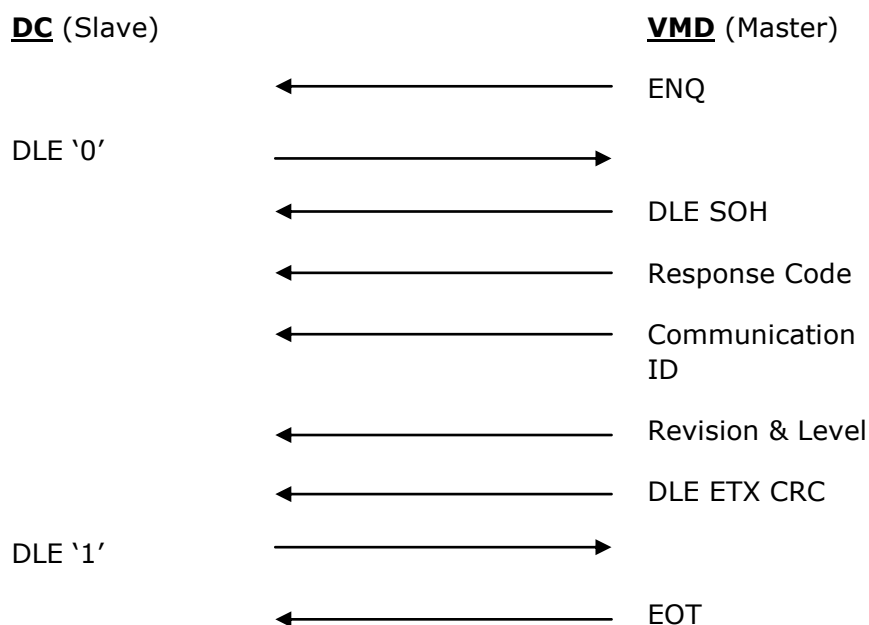

The CRC starts with the Response Code and ends with the ETX, excluding the DLE

10 digit Communication ID (Section 4.5.4)

Operation Request for Data Transfer Direction (Section 4.5.5)

R = Read (read audit information)

S = Send (send configuration information)

Revision & Level fixed at R01L01 or R00L06 (Section 4.5.6)

Response Code (Section 4.5.7)

00 = OK





First Handshake VMD Master / DC Slave (attempting to be master)

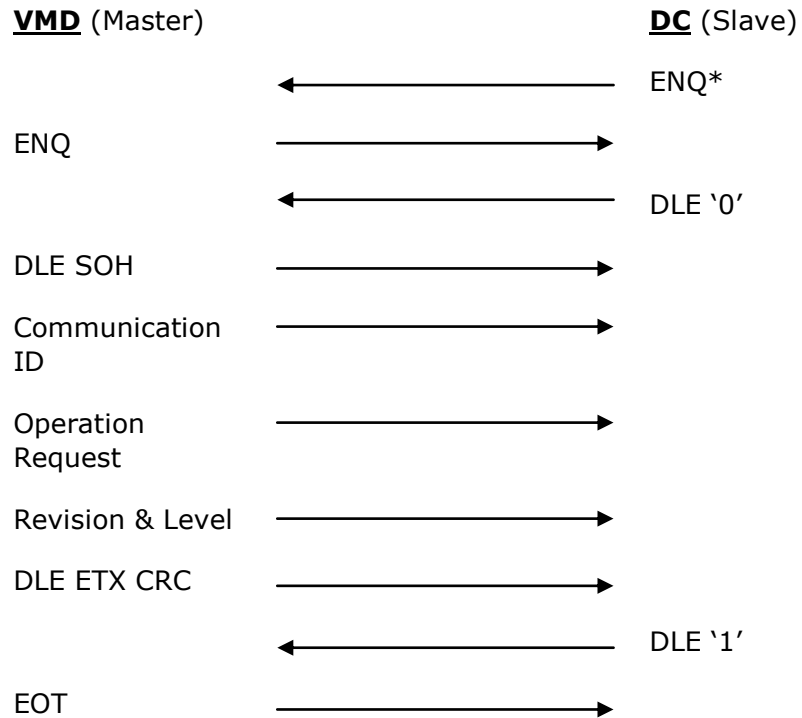

The CRC starts with the Comm ID and ends with the ETX, excluding the DLE

*ENQ ignored by VMD

Second Handshake

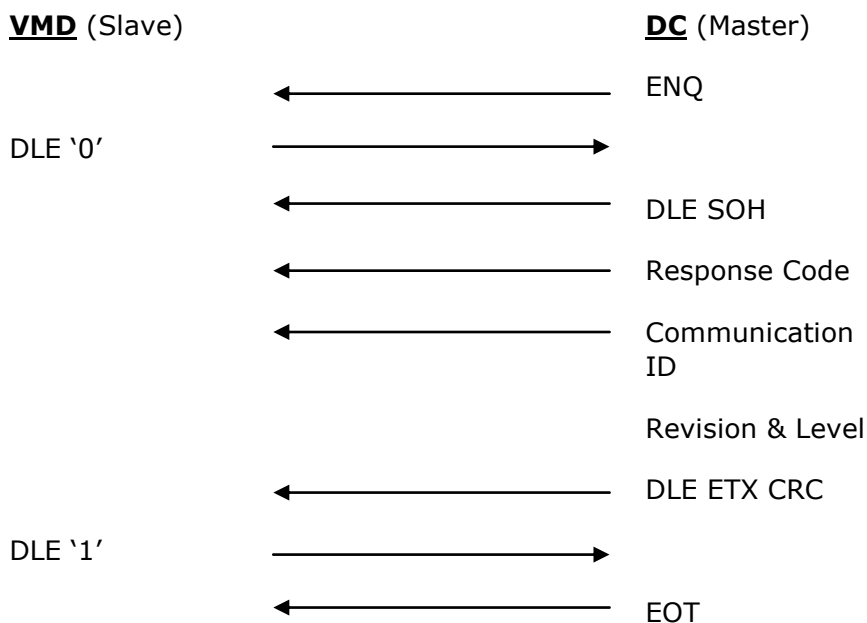

The CRC starts with the Response Code and ends with the ETX, excluding the DLE

10 digit Communication ID (Section 4.5.4)

Operation Request for Data Transfer Direction (Section 4.5.5)

S = Send (send audit information)

Revision and Level fixed at R01L01 or R00L06 (Section 4.5.6)

Response Code (Section 4.5.7)

00 = OK



4.5.4 Communication IDs

(ref: UCS/DSD Chapter VII Session Level)

During the First and Second Handshake the connected devices will transmit their respective Communication IDs. These IDs are ten alphanumeric characters which are either:

- the upper six (6) digits as assigned by the Uniform Code Council to uniquely identify each manufacturer. The lower four (4) digits are assigned by the manufacturer and can be varied as desired.

Or

- the upper three (3) characters are the manufacturer code as specified in Appendix B. The lower seven (7) digits are assigned by the manufacturer and can be varied as desired.

This method will be mandatory for all Version 6.0 and higher devices.

4.5.5 Operation Request

(ref: UCS/DSD Chapter VII Session Level)

The vending industry has adopted the "S" (Send) and "R" (Read) operation request designators and an "M" (Manufacturer Specific State) with the following definitions:

Data Carrier (DC) is Master for First Handshake

"S" = Request to send configuration data to VMD

"R" = Request to read audit data from VMD

"M" = Request to enter a Manufacturer Specific State

Version 6.0 has added the "M" operation request code that would be sent by the Master and interpreted by VMDs that are First Handshake Slaves to go into a manufacturer specific state following the completion of the Second Handshake with the "OK" response code (00). This allows Data Carriers (and/or manufacturing test equipment) to switch the VMD into a special state. This state is intended for non DEX/UCS communications and should only be used for hardware parameter setups, diagnostics, test-modes, FLASH memory downloads, etc.

Normal DEX/UCS cash and/or product setups must still be performed through the configuration data records as outlined in the Data Dictionary (Appendix A). The individual manufacturers shall determine their own serial communications parameters and protocols once the manufacture specific state is entered.

Vending Machine Device (VMD) is Master for First Handshake

"S" = Request to send data to DC



4.5.6 Revision & Level

(ref: UCS/DSD Chapter VII Session Level)

The vending industry initially adopted the single revision (R01) and level (L01) standard for the initial DEX/UCS implementation. Systems implementing the requirements of the EVA-DTS Version 6.0 and above should use the DTS version tracking number, e.g. DTS Version 6.0 would be revision 0 (R00) and level 6 (L06).

4.5.7 Response Codes

(ref: UCS/DSD Chapter VII Session Level)

During the Second Handshake, the Master device (Slave in the First Handshake) will send a Response Code. This code will determine whether or not the actual data transfer will take place. Although seven codes are defined (00 to 05, & 90) most vending applications only use Response Code 00 (OK).

- 00 = OK (to transfer data)
- 01 = Unrecognized Communication ID
- 02 = Unsupported Revision & Level
- 03 = Operation conflict, try again
- 04 = No data to transfer
- 05 = Undefined error
- 90 = Manufacturer Specific State

The vending industry has added a seventh code (90) which would be interpreted by VMDs that are First Handshake Masters to go into a manufacturer specific state following the completion of the Second Handshake. This allows Data Carriers (and/or manufacturing test equipment) to switch the VMD into a special state. This state is intended for non DEX/UCS communications and should only be used for hardware parameter setups, diagnostics, test-modes, etc.

Normal DEX/UCS cash and/or product setups must still be performed through the configuration data records as outlined in the Data Dictionary (Appendix A). The individual manufacturers shall determine their own serial communications parameters and protocols once the manufacture specific state is entered.



4.5.8 Timers and Limits

(ref: UCS/DSD Chapter VII Session Level)

All timer and limit definitions as specified in the referenced DEX/UCS documents shall apply and must be consulted for complete specifications. Additional timing requirements are listed below and are recommended for all new designs after July, 2002.

Response time: Before responding to an ENQ, data block, or any other transmitted control character (DLE 0/1 (ACK 0/1), NAK, etc.), the responding unit should wait a minimum of 10 milliseconds before answering back. Some devices can only operate in half-duplex mode and require a short period of time to switch over from send to receive. If the response is too quick, it may be received before the switch over is complete and be missed.

Intersession pause: As stated in Section 4.5, the DEX/UCS data transmission process consists of three consecutive sessions – two handshake sessions and one data exchange session. Before initiating the second or third session, the initiating device should pause a minimum of 100 milliseconds to avoid confusion in processing control characters associated with the end of one session and the beginning of the next.

Timer A margin: The sending device uses Timer A to protect against an invalid or no response from the receiving device. Upon sending an ENQ or completing the transmission of a block, the sending device starts Timer A (1 second) and then waits for the proper response. To provide margin, the receiving device should respond within no greater than 950 milliseconds.

If the receiving device cannot be ready with the normal response within the Timer A period, it can respond with a wait acknowledge represented by a WACK (DLE ;). To again provide margin, the receiving device should not wait the full second before responding with the WACK. It should instead respond back within 950 milliseconds.

Upon receiving the WACK, the sending device should wait between 100 to 500 milliseconds before sending the next ENQ to continue the data transfer process.

Timer B margin: The receiving device uses Timer B (100 milliseconds) to protect against the non-recognition of a block terminating character by the sending device. If the sending device wishes to pause while sending data, it should periodically (every 90 milliseconds or less) send TSYN (DLE SYN) characters as fillers. This will avoid a Timer B time-out.

Timer C margin: The DEX/UCS protocol does not use Timer C.

Timer D margin: Both the sending and receiving devices use Timer D (2 seconds) to protect against no activity during the First Handshake, the Second Handshake, or the Data Transfer. To provide for margin, it is recommended that devices wait at least 2.1 to 2.2 seconds before detecting a Timer D timeout situation.



Timer "O": It should be noted that Timer D is not an overall DEX timer and does not apply to the idle time before the First Handshake, the Second Handshake, or the Data Transfer. These times are specified as "indefinite". In essence, there could be an infinite amount of time between the DEX plug being inserted and the First Handshake, between the end of the First Handshake and the start of the Second Handshake, or between the end of the Second Handshake and the start of the Data Transfer.

To prevent against a vending system hang, it is recommended that VMDs initiate an overall non-activity timer of 60 seconds. This would start when the DEX plug is inserted (or electrically connected) or communication is established and would be restarted each time a character is transmitted or received. If this overall timeout is reached, the VMD should revert back to its normal vending functions.

4.6 SESSION / APPLICATION LEVEL DATA TRANSFER

(ref: **UCS/DSD Chapter VII Session Level**)

After initial communications is established in the beginning of the Session Level between the two devices, the data records are transmitted in either single or multiple block transfers until the communications is terminated.

It should be noted that the actual Data Transfer is considered part of the Session Level; however, the data content is considered part of the Application Level.





4.6.1 Data Transfer Formats

Audit Data Transfer from VMD to Data Carrier

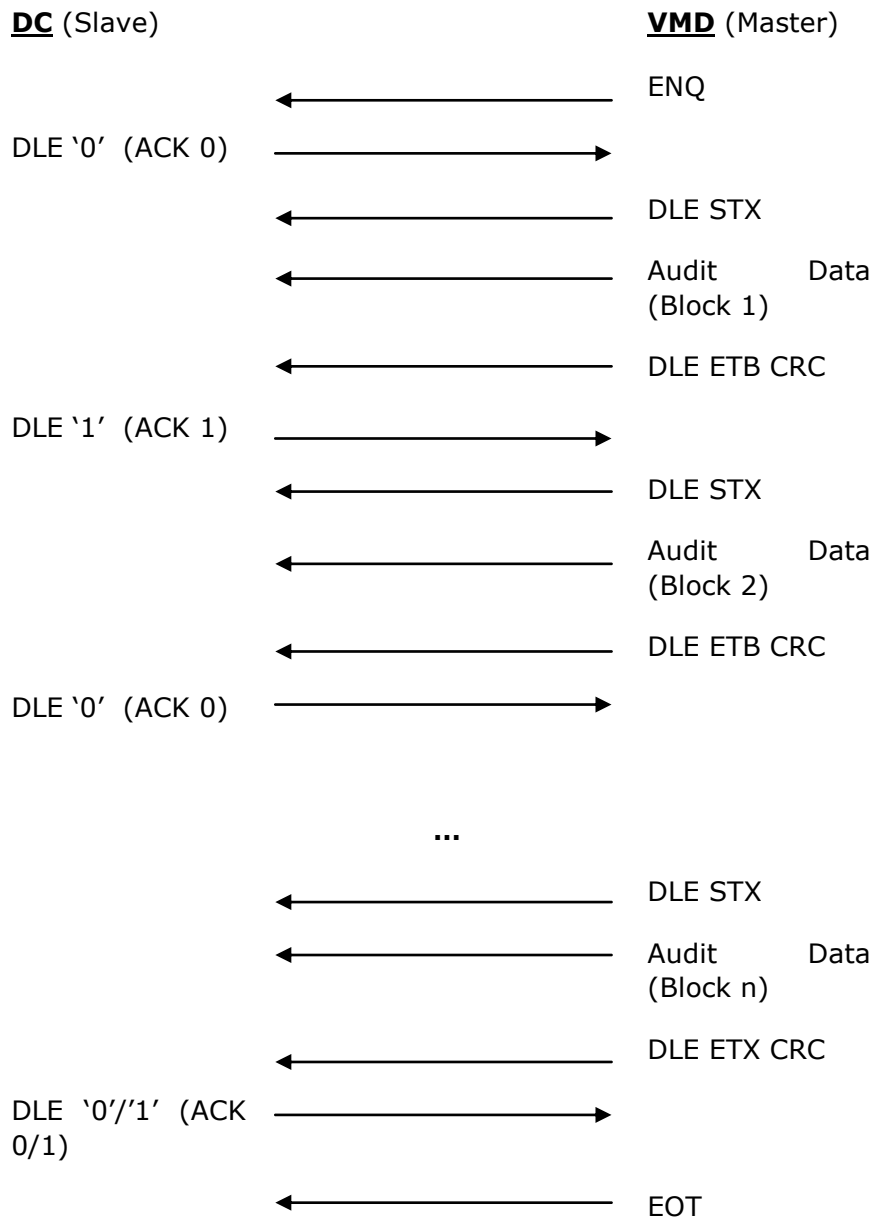

Each CRC starts with the Audit Data and ends with the ETB or ETX, excluding the DLE

Configuration Data Transfer from Data Carrier to VMD

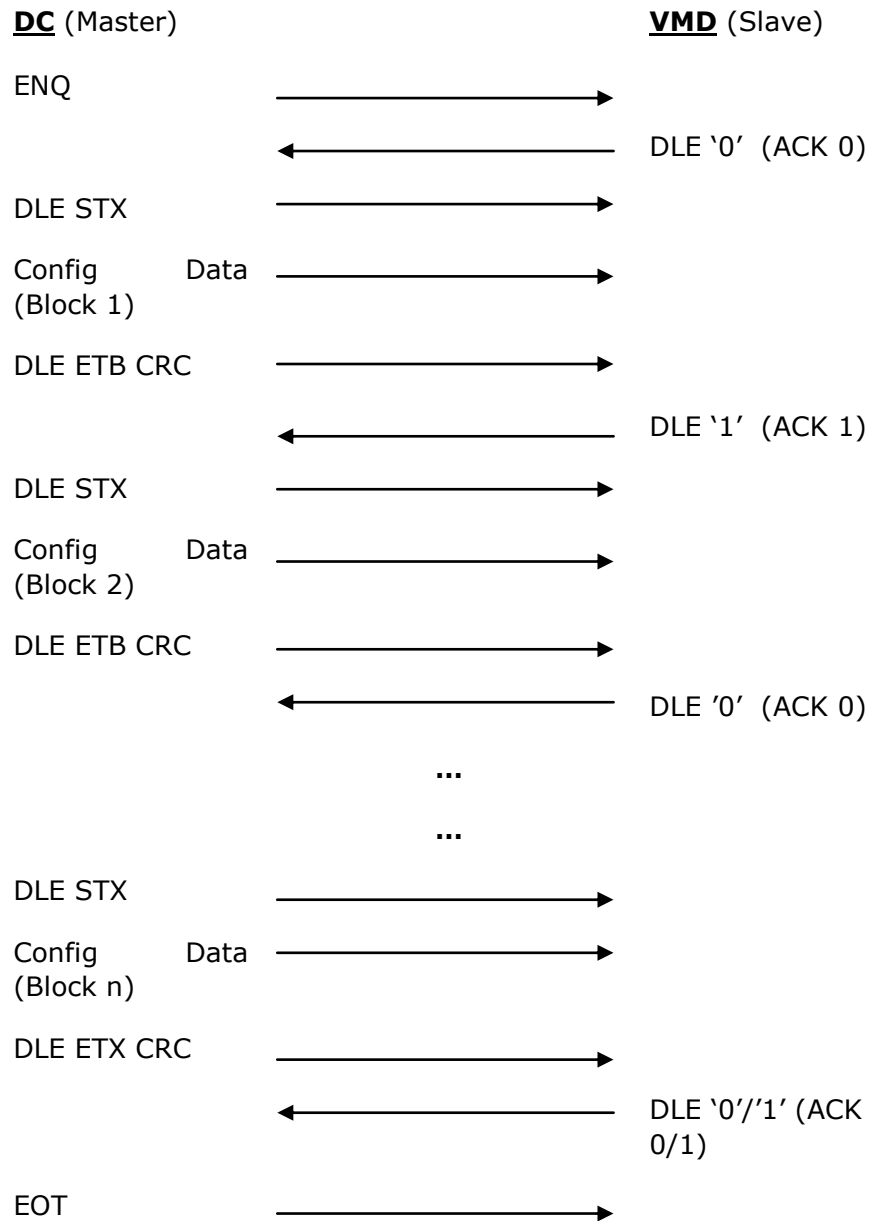

Each CRC starts with the Config Data and ends with the ETB or ETX, excluding the DLE



4.6.2 Overall Data Format

The overall format of the transferred data after the First and Second Handshake follows the format as defined in Chapter 2 of the Data Transfer Standard.

4.7 DEX DATA TRANSFER EXAMPLES

The following examples are provided to help clarify the overall format of a typical DEX data transfer between a Data Carrier (DC) and a Vending Machine Device (VMD). Note that numerous other data elements could be sent as specified in the Data Dictionary (Appendix A). The resettable elements are shown in **bold**.

The following example details an audit transfer initiated by the DC:

DC Communication ID XYZ1234567

VMD Communication ID QRS7654321

Vending Machine Model ABC1234, S/N 112233445566, Rev 0101

Located in "Building 1" with Asset Number 777888999

5 vends occurred (2 recent since last interval data reset)

1 recent cash from COL 1 (50c vend with \$1, 50c change)

1 previous cash from COL 2 (\$1 vend with \$1)

1 recent card from COL 3 (\$1 vend with \$1 card credit)

1 previous card from COL 3 (\$1 vend with \$1 card credit)

1 previous cash from COL 4 (50c vend with 50c)

0 vends from COL 5

4 audit reads 2 power-ons (1 recent since last interval data reset)





First Handshake (data sent from DC)

XYZ1234567RR00L06 (Request to Read)

Second Handshake (data sent from VMD)

QRS765432100R00L06 (OK)

Data Transfer (data sent from VMD)

DXS*RST7654321*VA*V0/6*1
ST*001*0001
ID1*112233445566*ABC1234*0101*Building 1**777888999
VA1*400*5***150*2**
CA2*200*3***50*1**
DA2*200*2***100*1**
CA3***100*0*0*1***250*50*0*2
CA4***50*0***50*0
PA1*COL 1*50*Snack 1
PA2*1*100***1*100**
PA1*COL 2*100*Snack 2
PA2*1*100***0*0**
PA1*COL 3*100*Snack 3
PA2*2*200***1*100**
PA1*COL 4*50*Snack 4
PA2*1*50***0*0**
PA1*COL 5*200*Snack 5
PA2*0*0***0*0**
EA3*4
EA7*1*2
G85*1234 (example G85 CRC is 1234)
SE*21*0001
DXE*1*1



The G85 CRC is calculated from the "S" in ST through the "CRLF" following EA7*1*2

The SE01 Number of Included Sets is calculated from ST through and including SE

The following example details a configuration initiated by the DC:

DC Communication ID XYZ1234567

VMD Communication ID QRS7654321

Asset Number will be changed to 55556666

COL 1 will have price changed to 25c and product changed to Mint 1

COL 2 will have price changed to 50c and product changed to Mint 2

COL 3 will have price changed to 75c and product changed to Mint 3

COL 4 will have price changed to \$1.00 and product changed to Mint 4

COL 5 will have price changed to \$1.25 and product changed to Mint 5

First Handshake (data sent from DC)

XYZ1234567SR00L06 (Request to Send)

Second Handshake (data sent from VMD)

QRS765432100R00L06 (OK)

Data Transfer (data sent from DC)

DXS*XYZ1234567*VA*V0/6*1

ST*001*0001

ID1*****55556666

PC1*COL 1*25*Mint 1

PC1*COL 2*50* Mint 2

PC1*COL 3*75* Mint 3

PC1*COL 4*100* Mint 4

PC1*COL 5*125* Mint 5

G85*1234 (example G85 CRC is 1234)

SE*9*0001

DXE*1*1

The G85 CRC is calculated from the "S" in ST through the "CRLF" following LE*0100

The SE01 Number of Included Sets is calculated from ST through and including SE





4.8 APPLICABLE DEX/UCS DOCUMENTATION

The Uniform Code Council document "UCS for Direct Store Delivery Implementation Guide" provides a tremendous amount of information as to the operation of DEX/UCS. Although the entire document is very informative, more is provided than what is actually required for the vending industry. The following highlights the sections which are required for implementing this specification. Note the document is organized into two parts, the main chapters in the front and the appendices in the back.

UCS/DSD Implementation Guide Chapters

(Version 004010UCS)

III. THE UCS/DSD STANDARDS

DXS/DXE HEADER/TRAILER CONTROL SEGMENTS

DEX/UCS COMMUNICATIONS STANDARDS

Direct Connect Interface Standard

VI. MESSAGE FORMATS

INTRODUCTION

Transaction Set Syntax

Classification of Data Elements and Segments

Data Element Types

Data Element Length

DEX/UCS CONTROL SEGMENTS

DXS – Application Header

DXE – Application Trailer

894 - DELIVERY/RETURN BASE RECORD

ST – Transaction Set Header

G85 – Record Integrity Check

SE – Transaction Set Trailer

VII. DIRECT CONNECT INTERFACE STANDARD

Appendix B – CRC GENERATION





CHAPTER 5 - APPLICATION NOTES - DATA

5.1. APPLICATION NOTES FOR THE DATA

5.1.1. Data Element Configuration

This section explains a method by which part of the Vending Machine's electronics configuration may be reported or changed. The example chosen is a Freshbrew Coffee Machine and the Data Groups shown in the example are ID1 and IC1 for reporting and changing configuration respectively.

Let us say that the Vending Machine is manufactured by the All Brewed Coffee Company (supplier ID code is ABC), and has serial number 9240571, and is an AB740 Machine Model with Build Standard 31. It is operated by the company Modern Vending Services (MVS) on site 19, which is located on route number 7, and has the MVS Machine Number 34.

The Asset Number of the Vending Machine is defined by the operator MVS to be a 2 digit route number, followed by a 2 digit site number and ending with a 2 digit machine number for that site. MVS managers also prefix their Asset Numbers with the User Code MVS, so as to ensure that they always get good data.

When first installed, the Vending Machine is able to report the manufacturer (ABC) programmed settings, which are contained in elements ID101, ID102 and ID103. These would be reported as follows within a longer stream of data from the machine :

ID1 * ABC9240571 * AB740 * 31 cr lf

If the installer only wanted to know the serial number, and was not interested in the model or build standard numbers, the report would be shorter :

ID1 * ABC9240571 cr lf

Note in both cases the unit serial number would normally be prefixed with the Manufacturer ID code from appendix B of this standard.





If the Installer now wishes to set the Asset Number of the unit, they now enter the number using their portable Data Carrier, and the Data Carrier would send to the Vending Machine the following information together with any other configuration information that may be required:

```
IC1 * ABC9240571 * * * * * MVS071934 cr lf
```

This could be shortened still further, since the machine to be configured has already been confirmed in the ID1 field sent by the machine prior to the transmission of the IC1 data. In this case, the message would appear as :

```
IC1 * * * * * MVS071934 cr lf
```

The Vending Machine Serial Number cannot be reset by the Installer or the route person at any time. Thus if the message `IC1 * MVS07 * * * * * MVS987654 cr lf` were to be sent, the Vending Machine **WOULD** change the Asset Number, but **WOULD NOT** change the Serial Number. In this method, Service Record integrity may be preserved, since the user always knows that the data for the Vending Machine ABC9240571 always refers to the one physical unit, and is never duplicated or altered.

Note that this example may also apply to the following units UNIT Reporting Changing

Vending Machine (shown above) ID1 IC1

Coin Mechanism CA1 CC1

Vending Machine Controller CB1 BC1

Cashless 1 DA1 DC1

Cashless 2 DB1 DD1

Communication Gateway FA1 FC1

Audit Module AM1 AC1

Token Acceptor TA1 TC1

Every unit has a programmable asset number. It is mainly used for tracking purposes. It is separate from the serial number and field configurable. Some units offer a keyboard or download option to program this asset number. However the operator needs one single asset number to identify a complete installation of a vending machine and its associated units (Coin Mechanism, Cashless Device, Controller Board, ...). The Control Board Asset Number of a Vending Machine is only related to the Control Board itself. It is not a mandatory field. Therefore the Machine Asset Number is the reference for accounting purposes. It is the mandatory field ID106. The Report Data Processing Software of an Operator requires the Machine Asset Number. A Vending Machine must offer the possibility to set ID106 in the field.





5.1.2. Manual Data Entry

From time to time the operator will have to deal with machines which are not equipped with modern electronics and are unable to report, for example, the number of cups or cans sold. In this case, the Standard makes provision for the portable Data Carrier to store the manually entered Meter / Counter Readings in Data Groups MR1 and MR2.

This requires the software of the Data Carrier - whose actual method of operation is outside the scope of this standard or application note - to be able to construct a Data Record as if it had come from an EVA_DTS compatible machine. This would require storage of the Machine Asset Number, in ID106, the relevant Meter Readings, and any other data that the operator may require.

For example, if MidShires Vending Services have machine 123 which has sold a total of 4567 cups since it was installed, the message stream could be as small as:

```
ID1 * * * * * MVS123 cr lf MR1 * 4567 cr lf
```

If output directly on a ticket printer, the above data would appear as:

```
ID1 * * * * * MVS123  
MR1 * 4567
```

which although not the easiest thing to understand to an untrained person, will make sense once explained. Clearly, the use of reported meter readings cannot prevent inaccurate reporting of sales information, since the person has to visually read the meter in the machine, then enter the data into their portable Data Carrier, before it can be entered to and processed by the Computer system.

5.1.3. Repeating Data Groups

A number of data elements are intended to be sent repeatedly, their application changing in accordance with one of the elements within the repeated groups, usually the first.

The example given here relates to the reporting of multiple product sales by which the information can be sent, either from the machine to the Data Carrier, or from the Carrier to the Computer.

Let us look at the data for two products sold from a snack machine





Table 1

Product	Keys consumer has to press to select the product	Selection index used inside the machine	Price	Product unique ID (e.g. Bar Code)	Spiral capacity	Filling level
Mars Bar	D6	46	23 p	5000159018 50	12	11
Polo Mint	E6	56	13 p	50251056	28	26



Let us say that the first product had sold 10 units this week, 300 since machine installation, and the second product had sold 20 units this week, 200 since machine installation.

The data reported by the fully EVA-DTS compatible system, giving all possible information mentioned, would be:

PA1 * 46 * 23 * 500015901850 * 12 * 11 cr lf

PA2 * 300 * 6900 * 10 * 230 cr lf

PA1 * 56 * 13 * 50251056 * 28 * 26 cr lf

PA2 * 200 * 2600 * 20 * 260 cr lf

If output directly on a ticket printer, the above data would appear as :

PA1 * 46 * 23 * 500015901850 * 12 * 11

PA2 * 300 * 6900 * 10 * 230

PA1 * 56 * 13 * 50251056 * 28 * 26

PA2 * 200 * 2600 * 20 * 260

clearly showing that the PA2 group describing the product sales follows the PA1 group, identifying which product.

Other examples of repeating information may be found, for example:

DA1-DA7 Debit Card transactions DA101

PA1 - PA5 Products Sold PA101

CA11 Coins Accepted CA1101

CA12 Coins Dispensed CA1201

CA13 Manually Filled Coin CA1301

CA14 Banknotes Accepted CA1401

TA7 Tokens Accepted TA701

TA8 Token Dispensed TA801

TA9 Tokens Filled TA901

LA1 PriceList LA101

EA1 Event Durations EA101

EA2 Event Occurrences EA201

EA8 Repeating Events EA801

TA9 Tokens Filled TA901

LA1 PriceList LA101

EA1 Event Durations EA101

EA2 Event Occurrences EA201

EA8 Repeating Events EA801

and so on.



5.1.4. Selective reporting and selective resetting of data elements

› 5.1.4.1. Using the command (CD) method

Typically all of the data elements are transferred from the vending machine device (**VMD**) to the data carrier (**DC**) but often is only a limited amount of data elements of interest for a specific operator/company. There is a provision in the **Data Transfer Standard** to transfer selected groups of data elements and thereby reduce the transmission time and the amount of data transmitted. Please be aware of that selective reporting and selective resetting of data elements are optional functionality. Underneath is an example showing the Principle of selective reporting and selective resetting of data elements. The **VMD** is in this example in AUTO mode (SD105 = AUTO) when the session starts.

VMD

DC

SD1*0*0*EA1, EA2, VA1SAVE**



The elements in **SD103** identify **EA1**, **EA2** and **VA1** to be reported during following audit readout. **SD105** is set to **SAVE** to instruct the **VMD** not to reset all **Interval Data Elements** after the following audit readout.

If SD103 is empty, then all data defined by list number will be read out.



All elements identified by block identifier **EA1**, **EA2** and **VA1** are reported in this readout

SD1*0*0*EA1,EA2*AUTO



The elements in **SD104** identify **EA1** and **EA2** to be reset when the **VMD** receives this message.

If SD104 is empty, then all resettable elements of the list will be rest.

SD105 is set to **AUTO**



› 5.1.4.2 Using the list method

Lists are defined in 3.6.1.2

READOUT OF DATA

There are 2 different principles, the record mask principle and the SD1 principle, to decide which data are to be read out.

THE SD1 PRINCIPLE

This principle works in the way that a specification file in the form of SD1 is sent (write) before the readout of data.

The field SD103 contains information about which data you wish to read out at the next readout (read); SD103 may contain either

- one or more data block identifiers (as PA1, EA1, etc) or
- record layout identifiers (L101, L102)

The elements composing the SD103 field are separated by commas.

The field SD104 can contain information about specific resettable data that you wish to reset after the next readout. (in same format as SD103)

The field SD105 can contain information about resetting of all resettable data after the next readout.

The field SD105 can accept the following values:

1 means: Reset all data

0 means: Don't reset, reset only data specified within SD104

If the field is not sent, the data will not be reset.

A record layout is a vendor specific layout of audit data, and is a specific list of audit data selected from the audit dictionary. L101 is the minimum EVA-DTS specified layout (see 2.4)



Example 1:

SD1*0*0*EA1,EA2,VA1*EA1,EA2CRLF

Read out SD103:EA1, Reset SD104:EA1, EA2

EA2 (event/error after next readout (read) protocol) and VA1 (sales audit) at the next readout (read).

Example 2:

SD1*0*0*EA1,EA2,VA1**1CRLF

Reset all resettable data after the next readout

The element ID1 (Machine Identification) is always sent, also in spite of the block identifier having not been specified in SD103.

Concerning "Message Sequence", please see the example "AUDIT COLLECTION WITH CONFIGURATION BY SD1" in update reference.

THE LIST NUMBER PRINCIPLE

If no SD103 specification (write) is sent, before a "read command" is given, all data will according to the "list number specification" be read out.

If a list 1 is read out the resettable data will hereafter be reset. If list 2 is read out, no data will be reset. The list contents can change from vendor to vendor, but some type of data must be present from any EVA-DTS compliant device. (set reference to minimum audit data list).

READ-IN OF DATA

If you wish to configurate/program a vending machine (write), it is often so that the machine must not contain any audit. In other words, an audit readout with a subsequent reset of resettable digits must be carried through, before the machine can be configurated (write).

Of course, you can send SD1 (write) even though there is audit in the vending machine.





5.1.5. Element Length

A special note is brought to the attention of all users of this standard, concerning the length of various data elements currently implemented in some US equipment which are equipped to provide data prior to this standard being formally published.

As indicated, each of the Vending Data Transfer data elements has a defined minimum and maximum length which provides for variable length data. This is a provision of the DEX/UCS standards which the Vending Industry has adopted. The DEX/UCS standards further state that for numeric and decimal data elements, no leading zeros are permitted to be transmitted.

Initial production vending machine audit devices (VMADs), that use the Direct Connect Communications Protocol, transmit fixed length data elements of eight (8) characters with leading zeros. These devices shall all be grandfathered and all portable data collection devices (PDCDs) should be capable of reading such data. All future VMAD products should adhere to the variable length data standard with the "no leading zeros" specification.

Shown below are the data element numbers which are known to be affected:

VA101	VA102	VA103	VA104				
CA201	CA202	CA203	CA204				
CA301	CA302	CA303	CA304	CA305	CA306	CA307	CA308
CA401	CA402	CA403	CA404				
CA501	CA502						
CA601							
DA201	DA202	DA203	DA204				
DA301	DA302						
DA401	DA402						
DA601	DA602						
EA301							
EA701	EA702						



5.1.6 Data Element Format (Type)

It is often observed that developers process elements in various ways when it comes to the limit of the available digits specified (e.g. "Nc 01 08"). In some cases the specified max. element length is used up after a short period of two years or less. In order to set clear rules for back office developers the following behavior must be implemented:

As soon as the maximum decimal value is reached measuring starts back at zero (e.g. after 99'999'999 continue with 0). It is not allowed to extend the element size even when the hexadecimal value would support it.

It is also possible for the machine to reach internal overflow conditions before the maximum specified element size has been reached. In this case, a reset of the value to '0' will be based on binary numbers (byte, word and double word)

Back office developers can detect an overflow by cross checking resettable and cumulative values of the last read out period. After each overflow the offset value according the maximum element length must be added to the new cumulative value (e.g. 327+100'000'000).

5.1.7 Price Lists

New vending machine software must allow the use of existing cashless systems and cards. This includes the use of specific price list numbers reflecting certain user groups. Through MDB communication the cashless device reports any price list that was programmed on the cashless card. Typically this is 0, 1 or 2. Therefore the vending machine must provide a configuration menu that allows matching the given price list on the cashless cards with the programmable price lists on the machine. Any card price list that is not recognized automatically shall be diverted per default to price list 1.

Example	Cashless 1	Cashless 1	Cashless 2	Cashless 2
Price list on cashless card	0	1	1	3
Reported Price List	1	2	1	2



- › 5.1.7.1 Cashless Pricelist number is defined with MDB "BEGINN SESSION Z10"; this number is programmed on the cashless card.
- › 5.1.7.2 Vending machine supplier can obtain a menu for pricelist routing: the price list number of the cashless card shall be connected with the reporting price list number of the vending machine (see example above).
- › 5.1.7.3 All prices in all price lists shall be set to a default value (0xFFFF) before settings are done.
- › 5.1.7.4 Test sales are reported in PA3; these elements report the total cash AND cashless test sales
- › 5.1.7.5 Free vends are reported in PA4; includes free vends induced by the machine AND the cashless system

A vending machine may allow different product prices during specified time bands. In this case the vending machine uses additional price lists to those previously configured for cash and cashless vends.

As from EVA-DTS version 6.1 the PA2 and LA elements shall be grandfathered as far as PA7 reporting is fully implemented.





5.1.8 Mixed Payment Reporting

Often the consumer uses up his cashless fund until the remaining value is too low to buy the desired product. In the case where revaluation is not allowed at the vending machine it can support mixed payment where the required funds are provided via cash and cashless systems. Usually the added cash is used up first before the remaining amount is reduced from the cashless system:

Example 1:

Situation	Action	Display	Audit (Revaluation not allowed)	
Product Price € 1.50	Insert cashless card	€ 0.70	CA2 Value of cash sales	€ 1.00
Cashless Funds € 0.70			CA2 Number of cash vends	1
	Insert € 1.00	€ 1.70	DA2 Value of cashless sales	€ 0.50
			DA2 Number of cashless sales	1
Selection	Cash sales € 1.00	€ 0.20	DA10 Number of Mixed Payment Vends	1
	Cashless sales € 0.50		DA10 Mixed Payment Cashless Amount	€ 0.50
	Dispense product		PA8 Value of mixed payment cash amount	€ 1.00
			PA8 Number of mixed payment vends	1
Change	Return cash € 0	€ 0.20		

The value is reported into the system where it came from (Cash: 1 Euro / Cashless 50 cents). The back office must adjust product statistics as the product is registered twice:

Number of vends: PA708(CA)+ PA708(DA)+ PA708(DB)-PA803

In the example above: 1 + 1 + 0 -1 = 1

It is recommended to update the machine statistics after the "Vend Success". Otherwise all counters and values would need to be set back to the previous status in the case of a product dispense failure.





Example 2:

In this example the product costs € 0.70 when paid with card and € 0.80 when paid with cash.

Situation	Action	Display	Audit (Revaluation not allowed)
Product Price € 0.80 / 0.70	Insert cashless card	€ 0.50	CA2 Value of cash sales € 0.70
Cashless Funds € 0.50			CA2 Number of cash vends 1
	Insert € 1.00	€ 1.50	DA2 Value of cashless sales € 0.00
			DA2 Number of cashless sales 1
Selection	Cash sales € 0.70	€ 0.80	DA10 Number of Mixed Payment Vends 1
	Cashless sales € 0.00		DA10 Mixed Payment Cashless Amount € 0.00
	Dispense product		PA8 Mixed payment cash amount € 0.70
Change	Return cash € 0.30	€ 0.50	PA8 Number of mixed payment vends 1

The value is reported into the system where it came from (Cash: 0.70 Euro). This in fact is a mixed payment as cashless conditions apply and cash funds are used.

The examples above can be similarly applied for Cashless 2. Mixed free vends are not possible.

5.1.9 Difference between "zero price vends" and "free vends"

Please refer Appendix A, "free vend" definition.





5.1.10 Product Level related elements

The following elements are mainly used in remotely managed vending machines (commonly used term: telemetry). The examples given in the table below reflect typical implementations in the current state-of-the-art (2007).

Element	Name	Vending Machine Activity	Filler Activity
PA104	Maximum Capacity	Product Configured via PC104 or menu or preset in factory (default)	PC104, download via data carrier
PA105	Standard Filling Level	Configured via PC105 or menu	PC105, download via data carrier
PA106	Standard Dispensed Quantity	Configured via PC106 or menu	PC106, download via data carrier
PA107	Selection Status	Update with each change of status	
PA108	Current Product Level	Update value after each product vend and after each refill action	PC108, download current level via data carrier after each refill
PA109	Minimum Product Level	Issue event triggering refill activities	PC109, download trigger level via data carrier as required

5.2. EXAMPLES OF UPDATING DTS DATA FIELDS

This section gives examples of how data can be updated. It is not exhaustive and implementers must insure all relevant elements are modified accordingly.

As from EVA-DTS version 6.1 the PA2 and LA elements shall be grandfathered as far as PA7 reporting is fully implemented.



5.2.1 Continuous update

All EVA-DTS elements must be updated with current transaction values. The calculation of monetary totals by multiplying counters with prices may lead to incorrect audit data (example: a price change during the read-out period would lead to incorrect audit data) and is therefore not allowed.

5.2.2 Value Token reporting

Some manufacturers do report value token in CA3. This behaviour is not allowed. Value token are not cash. Tokens shall be reported separately in their dedicated blocks (TA).

5.2.3 Vend Examples

1. Field Used In Example
2. Cash Vend Example
3. Card Vend Example
4. Cash and Non-Revalue Card Vend Example
5. Card Vend (With Discount) Example
6. Card Vend (With Surcharge) Example
7. Vend Token Vend Example
8. Value Token Vend Example
9. Value Token Vend (With Overpay) Example
10. Cash vend Pre-Select (Cup discount) Example
11. Card vend Pre-Select (Cup discount) Example
12. Card vend Pre-Select (card discount) Example
13. Cash vend Pre-Select (surcharge) Example
14. Cash vend (prices lists) Example
15. Card vend (prices lists) Example
16. Value Token Vend (prices lists) Example





5.2.4. Cash Examples

1. Fields Used In Examples

2. Changer Manual Fill Tubes
3. Changer Manual Fill Cash
4. Changer Manual Dispensed
5. Insert Coin Into Cash-Box
6. Insert Coin Into Tubes
7. Escrow (Coins Dispensed)
8. Overpay
9. Card Revalue
10. Insert Banknote

5.2.3. Vend Examples

These examples do not show all concerned data blocks within a vend session. They only describe the treatment of related data blocks under specific circumstances.

› 5.2.3.1 Fields Used In Examples

VA1, CA2, CA7, DA2, DA5, DA10, TA2, TA3, TA5, PA1, (PA2, LA1), PA7, PA8

VA1*0*0*0*0*0*0*0*0*0*0*0

VA101	value of all paid vend sales since initialization $VA101 = CA201 + DA201 + DB201 + TA201 + TA205$
VA102	number of all paid vend sales since initialization
VA103	value of all paid vend sales since last reset $VA103 = CA203 + DA203 + DB203 + TA203 + TA207$
VA104	number of all paid vend sales since last reset
VA105	value of all discounted paid vends since initialization
VA106	number of all discounted paid vends since initialization
VA107	value of all discounted paid vends since last reset
VA108	number of all discounted paid vends since last reset
VA109	value of all surcharged paid vends since initialization
VA110	number of all surcharged paid vends since initialization
VA111	value of all surcharged paid vends since last reset
VA112	number of all surcharged paid vends since last reset





CA2*0*0*0*0

CA201 Value of cash sales (coins+ banknotes) since initialization
CA202 number of cash sales since initialization
CA203 Value of cash sales since last reset
CA204 number of cash sales since last reset

DA2*0*0*0*0

DA201 Value of card sales since initialization
DA202 number of card sales since initialization
DA203 Value of card sales since last reset
DA204 number of card sales since last reset

DA5*0*0*0*0*0*0*0

DA501 Value of card discounts since last reset
DA502 number of card discounts since last reset
DA503 Value of card discounts since initialization
DA504 number of card discounts since initialization
DA505 Value of card surcharges since last reset
DA506 number of card surcharges since last reset
DA507 Value of card surcharges since initialization
DA508 number of card surcharges since initialization

DA10*0*0*0*0

DA1001Cashless 1 Number of Mixed Payment Vends Since Initialization
DA1002Cashless 1 Value of Mixed Payment Cashless Amount Since Initialization
DA1003Cashless 1 Number of Mixed Payment Vends Since Last Reset
DA1004Cashless 1 Value of Mixed Payment Cashless Amount Since Last Reset

TA2*0*0*0*0*0*0*0

TA201 Value of all vend token sales since initialization
TA202 number of all vends token sales since initialization
TA203 Value of all vend token sales since last reset
TA204 number of all vends token sales since last reset
TA205 Value of all value token sales since initialization
TA206 number of all value token sales since initialization
TA207 Value of all value token sales since last reset
TA208 number of all value token sales since last reset

TA5*0*0

TA501 Value of value token overpay received since last reset
Insert money –change paid – vend price = overpay value
TA502 Value of value token overpay received since initialization





PA1*1*40***0**

PA101 Product number
PA102 price of the product
PA107 Selection status:
0 or blank = present
1 = not present

PA2*0*0*0*0*0*0*0* (use PA7)

PA201 number of paid products vended since initialization
PA202 value of paid products vended since initialization
PA203 number of paid products vended since last reset
PA204 value of paid products vended since last reset
PA205 number of discounted paid vends since initialization
PA206 value of discounted paid vends since initialization
PA207 number of discounted paid vends since last reset
PA208 value of discounted paid vends since last reset
PA209 number of surcharges paid since initialization
PA210 value of surcharges paid since initialization
PA211 number of surcharges paid since last reset
PA212 value of surcharges paid since last reset

LA1*0*0*0*0*0 (use PA7)

LA101 price list number
LA102 product number
LA103 price
LA104 number of vends since last reset
LA105 number of vends since initialization

PA7*0*0*0*0*0*0*0

PA701 Product Number
PA702 Payment device
PA703 Price list number
PA704 Applied Price
PA705 Number of sales Since Initialization
PA706 Value of Sales since Initialization
PA707 Number of sales Since Last Reset
PA708 Value of Sales since Last Reset

PAS*0*0*0*0

PA801 Number of Mixed Payment Vends Since Initialization
PA802 Value of Mixed Payment Cash Amount Since Initialization
PA803 Number of Mixed Payment Vends Since Last Reset
PA804 Value of Mixed Payment Cash Amount Since Last Reset





› 5.2.3.2 Cash Vend Example

User makes selection line = 6 price=0.40

VA1

VA101 value = value + 40 (PA1*6*40)
VA102 number = number +1
VA103 value = value + 40 (PA1*6*40)
VA104 number = number +1

CA2

CA201 value = value + 40 (PA1*6*40)
CA202 number = number +1
CA203 value = value + 40 (PA1*6*40)
CA204 number = number +1

Line 6

PA1

PA101 = 6 (product number)
PA102 = 40 (price)
PA107 = 0 (present)

PA2 (use PA7)

PA201 number = number +1
PA202 value = value + 40 (PA1*6*40)
PA203 number = number +1
PA204 value = value + 40 (PA1*6*40)

PA7

PA701 = 6 (product number)
PA702 = CA (payment device)
PA704 = 40 (price)
PA705 number = number +1
PA706 value = value + 40
PA707 number = number +1
PA708 value = value + 40





› 5.2.3.3 Card Vend Example

User makes selection line =6 price=0.40 pricelist=1

VA1

VA101 value = value + 40 (PA1*6*40)
VA102 number = number +1
VA103 value = value + 40 (PA1*6*40)
VA104 number = number +1

DA2

DA201 Value =value + 40 (PA1*6*40)
DA202 number = number +1
DA203 Value =value + 40 (PA1*6*40)
DA204 number = number +1

Line 6

PA1

PA101 = 6 (product number)
PA102 = 40 (price)
PA107 = 0 (present)

PA2 (use PA7)

PA201 number = number +1
PA202 value = value + 40 (PA1*6*40)
PA203 number = number +1
PA204 value = value + 40 (PA1*6*40)

PA7

PA701 = 6 (product number)
PA702 = DA (payment device)
PA703 = 1 (price list number)
PA704 = 40 (price)
PA705 number = number +1
PA706 value = value + 40
PA707 number = number +1
PA708 value = value + 40





› 5.2.3.4 Cash and Non-Revalue Card Vend Example

Selection line 6 price=0.40

User insert a non-revalue credit card with credit = 15

And he insert coins = 25

CA2

CA201 value = value + 25

CA202 number = number + 1

CA203 value = value + 25

CA204 number = number + 1

DA2

DA201 Value =value + 15

DA202 number = number + 1

DA203 Value =value + 15

DA204 number = number + 1

DA10

DA1001 number = number + 1

DA1002 value =value + 15

DA1003 number = number + 1

DA1004 value =value + 15

VA1

VA101 value = value + 40 (PA1*6*40)

VA102 number = number +1

VA103 value = value + 40 (PA1*6*40)

VA104 number = number +1

Line 6

PA1

PA101 = 6 (product number)

PA102 = 40 (price)

PA107 = 0 (present)

PA2 (use PA7)

PA201 number = number +1

PA202 value = value + 40 (PA1*6*40)

PA203 number = number +1

PA204 value = value + 40 (PA1*6*40)





PA7

PA701 = 6 (product number)
PA702 = CA (payment device)
PA704 = 40 (price)
PA705 number = number +1
PA706 value = value + 25
PA707 number = number +1
PA708 value = value + 25
PA701 = 6 (product number)
PA702 = DA (payment device)
PA703 = 1 (price list number)
PA704 = 40 (price)
PA705 number = number +1
PA706 value = value + 15
PA707 number = number +1
PA708 value = value + 15

PA8

PA801 number = number +1
PA802 value = value + 25
PA803 number = number +1
PA804 value = value + 25

› 5.2.3.5 Card Vend (With Discount) Example

*User makes selection line = 6
price list 1 price=0.40
pricelist 2 price=0.10
(card vend 0.30 (card discount 0.40-0.30=0.10))*

VA1

VA101 value = value + 40 (PA1*6***40**)
VA102 number = number +1
VA103 value = value + 40 (PA1*6***40**)
VA104 number = number +1
VA105 value = value + 10 (PA1*6***40**)-card vend **30**
VA106 number = number +1
VA107 value = value + 10
VA108 number = number +1





DA2

DA201	Value =value + 40	(PA1*6*40)
DA202	number = number +1	
DA203	Value =value + 40	(PA1*6*40)
DA204	number = number +1	

DA5

DA501	Value = value + 10	(PA1*6*40)- card vend 30
DA502	number = number +1	
DA503	Value = value + 10	(PA1*6*40)- card vend 30
DA504	number = number +1	

Line 6

PA1

PA101 = 6 (product number)
PA102 = 40 (price)
PA107 = 0 (present)

PA2 (use PA7)

PA201	number = number +1	
PA202	value = value + 40	(PA1*6*40)
PA203	number = number +1	
PA204	value = value + 40	(PA1*6*40)
PA205	number = number +1	
PA206	value = value + 10	(PA1*6*40) - card vend 30
PA207	number = number +1	
PA208	value = value + 10	(PA1*6*40)- card vend 30

PA7

PA701 = 6 (product number)
PA702 = DA (payment device)
PA703 = 2 (price list number)
PA704 = 10 (price)
PA705 number = number +1
PA706 value = value + 10
PA707 number = number +1
PA708 value = value + 10





› 5.2.3.6 Card Vend (With Surcharge) Example

User makes selection line = 6
pricelist 1 price=0.40
pricelist 3 price=0.45
(card vend 0.45 (card surcharge 0.45-0.40=0.05))

VA1

VA101 value = value + 40 (PA1*6*40)
VA102 number = number +1
VA103 value = value + 40 (PA1*6*40)
VA104 number = number +1
VA109 value = value + 5 card vend **45** - (PA1*6*40)
VA110 number = number +1
VA111 value = value + 5
VA112 number = number +1

DA2

DA201 Value =value + 40 (PA1*6*40)
DA202 number = number +1
DA203 Value =value + 40 (PA1*6*40)
DA204 number = number +1

DA5

DA505 Value = value + 5 card vend **45** - (PA1*6*40)
DA506 number = number +1
DA507 Value = value + 5 card vend **45** - (PA1*6*40)
DA508 number = number +1

Line 6

PA1

PA101 = 6 (product number)
PA102 = 40 (price)
PA107 = 0 (present)

PA2 (use PA7)

PA201 number = number +1
PA202 value = value + 40 (PA1*6*40)
PA203 number = number +1
PA204 value = value + 40 (PA1*6*40)
PA209 number = number +1
PA210 value = value + 5 card vend **45** - (PA1*6*40)
PA211 number = number +1
PA212 value = value + 5 card vend **45** - (PA1*6*40)





PA7

PA701 = 6 (product number)
PA702 = DA (payment device)
PA703 = 3 (price list number)
PA704 = 45 (price)
PA705 number = number +1
PA706 value = value + 45
PA707 number = number +1
PA708 value = value + 45

› 5.2.3.7 Vend Token Vend Example

Selection line 6 price=0.40

VA1

VA101 value = value + 40 (PA1*6*40)
VA102 number = number +1
VA103 value = value + 40 (PA1*6*40)
VA104 number = number +1

TA2

TA201 value = value +40 (PA1*6*40)
TA202 number = number +1
TA203 value = value +40 (PA1*6*40)
TA204 number = number +1

PA1

Line 6
PA101 = 6 (product number)
PA102 = 40 (price)
PA107 = 0 (present)

PA2 (use PA7)

PA201 number = number +1
PA202 value = value + 40 (PA1*6*40)
PA203 number = number +1
PA204 value = value + 40 (PA1*6*40)

PA7

PA701 = 6 (product number)
PA702 = TA (payment device)
PA704 = 40 (price)
PA705 number = number +1
PA706 value = value + 40
PA707 number = number +1
PA708 value = value + 40





› 5.2.3.8 Value Token Vend Example

Selection line 6 price=0.40
Value Token=0.40

VA1

VA101 value = value + 40 (PA1*6***40**)
VA102 number = number + 1
VA103 value = value + 40 (PA1*6***40**)
VA104 number = number + 1

TA2

TA205 value = value + 40 (PA1*6***40**)
TA206 number = number + 1
TA207 value = value + 40 (PA1*6***40**)
TA208 number = number + 1

PA1

Line 6
PA101 = 6 (product number)
PA102 = 40 (price)
PA107 = 0 (present)

PA2 (use PA7)

PA201 number = number + 1
PA202 value = value + 40 (PA1*6***40**)
PA203 number = number + 1
PA204 value = value + 40 (PA1*6***40**)

PA7

PA701 = 6 (product number)
PA702 = TA (payment device)
PA704 = 40 (price)
PA705 number = number + 1
PA706 value = value + 40
PA707 number = number + 1
PA708 value = value + 40





› 5.2.3.9 Value Token Vend (With Overpay) Example

Selection line 5 price=0.30

Value Token=0.40 (overpay 0.40-0.30 = 0.10)

VA1

VA101 value = value + 30 (PA1*5***30**)

VA102 number = number +1

VA103 value = value + 30 (PA1*5***30**)

VA104 number = number +1

TA2

TA205 value = value + 30 (PA1*5***30**)

TA206 number = number + 1

TA207 value = value + 30 (PA1*5***30**)

TA208 number = number + 1

TA3

TA301 value = value + 40

TA302 value = value + 40

TA5

TA501 Value = value + 10 (**40** -Pa1*5***30** = 10)

TA502 Value = value + 10

PA1

Line 5

PA101 = 5 (product number)

PA102 = 30 (price)

PA107 = 0 (present)

PA2 (use PA7)

PA201 number = number +1

PA202 value = value + 30 (PA1*5***30**)

PA203 number = number +1

PA204 value = value + 30 (PA1*5***30**)

PA7

PA701 = 5 (product number)

PA702 = TA (payment device)

PA704 = 30 (price)

PA705 number = number +1

PA706 value = value + 30

PA707 number = number +1

PA708 value = value + 30





› 5.2.3.10 Cash Vend Pre-Select (Cup Discount) Example

pre-selection line 12 no-cup discount price =0.35
selection line 6 price =0.40
VMC vend 0.40-0.05= 0.35 (discount no cup 0.05)

VA1

VA101 value = value + 35 (PA1*12***35**)
VA102 number = number +1
VA103 value = value + 35 (PA1*12***35**)
VA104 number = number +1

CA2

CA201 value = value + 35 (PA1*12***35**)
CA202 number = number +1
CA203 value = value + 35 (PA1*12***35**)
CA204 number = number +1

Line 12

PA1

PA101 = 12 (product number)
PA102 = 35 (price)
PA107 = 0 (present)

PA2 (use PA7)

PA201 number = number + 1
PA202 value = value + 35 (PA1*12***35**)
PA203 number = number + 1
PA204 value = value + 35 (PA1*12***35**)

PA7

PA701 = 12 (product number)
PA702 = CA (payment device)
PA704 = 35 (price)
PA705 number = number +1
PA706 value = value + 35
PA707 number = number +1
PA708 value = value + 35





› 5.2.3.11 Card Vend Pre-Select (Cup Discount) Example

pre-selection line 12 no-cup discount price =0.35
selection line 6 price =0.40
VMC vend 0.40-0.05= 0.35 (discount no cup 0.05)

VA1

VA101 value = value + 35 (PA1*12***35**)
VA102 number = number +1
VA103 value = value + 35 (PA1*12***35**)
VA104 number = number +1

DA2

DA201 value = value + 35 (PA1*12***35**)
DA202 number = number +1
DA203 value = value + 35 (PA1*12***35**)
DA204 number = number +1
Line 12

PA1

PA101 = 12 (product number)
PA102 = 35 (price)
PA107 = 0 (present)

PA2 (use PA7)

PA201 number = number + 1
PA202 value = value + 35 (PA1*12***35**)
PA203 number = number + 1
PA204 value = value + 35 (PA1*12***35**)

PA7

PA701 = 12 (product number)
PA702 = DA (payment device)
PA703 = 1 (price list number)
PA704 = 35 (price)
PA705 number = number +1
PA706 value = value + 35
PA707 number = number +1
PA708 value = value + 35





› 5.2.3.12 Card Vend Pre-Select (Card Discount) Example

pre-selection line 12 no-cup discount price = 0.35

selection line 6 price = 0.40

VMC vend 0.35 (discount no cup 0.05)

Card vend 0.30 (discount card 0.35 - 0.30 = 0.05)

pricelist 1 price=0.35 (pre-selection 12)

pricelist 2 price=0.30

VA1

VA101 value = value + 35 (PA1*12***35**)

VA102 number = number +1

VA103 value = value + 35 (PA1*12***35**)

VA104 number = number +1

VA105 value = value + 5 (VMC vend 35 – card vend 30)

VA106 number = number +1

VA107 value = value + 5

VA108 number = number +1

DA2

DA201 value = value + 35 (PA1*12***35**)

DA202 number = number +1

DA203 value = value + 35 (PA1*12***35**)

DA204 number = number +1

DA5

DA501 Value = value + 5 (VMC vend 35 – card vend 30)

DA502 number = number +1

DA503 Value = value + 5

DA504 number = number +1

Line 12

PA1

PA101 = 12 (product number)

PA102 = 35 (price)

PA107 = 0 (present)





PA2 (use PA7)

PA201	number = number + 1	
PA202	value = value + 35	(PA1*12* 35)
PA203	number = number + 1	
PA204	value = value + 35	(PA1*12* 35)
PA205	number = number + 1	
PA206	value = value + 5	(VMC vend 35 – card vend 30)
PA207	number = number + 1	
PA208	value = value + 5	

PA7

PA701	= 12	(product number)
PA702	= DA	(payment device)
PA703	= 2	(price list number)
PA704	= 30	(price)
PA705	number = number +1	
PA706	value = value + 30	
PA707	number = number +1	
PA708	value = value + 30	

› 5.2.3.13 Cash Vend Pre-Select (Surcharge) Example

pre-selection line 1 extra-milk price = 0.45
selection line 6 price = 0.40
VMC vend 0.40 + 0.05 = 0.45

VA1

VA101	value = value + 45	(PA1*1* 45)
VA102	number = number +1	
VA103	value = value + 45	(PA1*1* 45)
VA104	number = number +1	

CA2

CA201	value = value + 45	(PA1*1* 45)
CA202	number = number +1	
CA203	value = value + 45	(PA1*1* 45)
CA204	number = number +1	

Line 1

PA1

PA101	= 1	(product number)
PA102	= 45	(price)
PA107	= 0	(present)





PA2 (use PA7)

PA201 number = number + 1
PA202 value = value + **45** (PA1*1***45**)
PA203 number = number + 1
PA204 value = value + **45** (PA1*1***45**)

PA7

PA701 = 1 (product number)
PA702 = CA (payment device)
PA704 = 45 (price)
PA705 number = number + 1
PA706 value = value + 45
PA707 number = number + 1
PA708 value = value + 45

› 5.2.3.14 Cash Vend (Prices Lists)

LIST 0 Example

list 0 line = 6 price=0.40
list 1 line = 6 price=0.30
list 2 line = 6 price=0.50
User makes selection list 0 line = 6 price= 0.40

VA1

VA101 value = value + 40 (LA1*0*6***40**)
VA102 number = number + 1
VA103 value = value + 40 (LA1*0*6***40**)
VA104 number = number + 1

CA2

CA201 Value = value + 40 (LA1*0*6***40**)
CA202 number = number + 1
CA203 Value = value + 40 (LA1*0*6***40**)
CA204 number = number + 1

Line 6

PA1

PA101 = 6 (product number)
PA102 = (price)
PA107 = 0 (present)





PA2 (use PA7)

PA201 number = number + 1
PA202 value = value + 40 (LA1*0*6*40)
PA203 number = number + 1
PA204 value = value + 40 (LA1*0*6*40)

LA1 (use PA7)

LA101 = 0
LA102 = 6
LA103 = 40
LA104 number = number + 1
LA105 number = number + 1

PA7

PA701 = 6 (product number)
PA702 = CA (payment device)
PA703 = 0 (price list number)
PA704 = 40 (price)
PA705 number = number + 1
PA706 value = value + 40
PA707 number = number + 1
PA708 value = value + 40

› 5.2.3.14 Cash Vend LIST 1 Example

list 0 line = 6 price=0.40
list 1 line = 6 price=0.30
list 2 line = 6 price=0.50
User makes selection list 1 line = 6 price = 0.30

VA1

VA101 value = value + 30 (LA1*1*6*30)
VA102 number = number + 1
VA103 value = value + 30 (LA1*1*6*30)
VA104 number = number + 1

CA2

CA201 Value =value + 30 (LA1*1*6*30)
CA202 number = number + 1
CA203 Value =value + 30 (LA1*1*6*30)
CA204 number = number + 1
Line 6





PA1

PA101 = 6 (product number)

PA102 = (price)

PA107 = 0 (present)

PA2 (use PA7)

PA201 number = number + 1

PA202 value = value + 30 (LA1*1*6*30)

PA203 number = number + 1

PA204 value = value + 30 (LA1*1*6*30)

LA1 (use PA7)

LA101 = 1

LA102 = 6

LA103 = 30

LA104 number = number + 1

LA105 number = number + 1

PA7

PA701 = 6 (product number)

PA702 = CA (payment device)

PA703 = 1 (price list number)

PA704 = 30 (price)

PA705 number = number +1

PA706 value = value + 30

PA707 number = number +1

PA708 value = value + 30





Cash Vend LIST 2 Example

list 0 line = 6 price=0.40

list 1 line = 6 price=0.30

list 2 line = 6 price=0.50

User makes selection list 2 line = 6 price = 0.50

VA1

VA101 value = value + 50 (LA1*2*6*50)

VA102 number = number + 1

VA103 value = value + 50 ((LA1*2*6*50)

VA104 number = number + 1

CA2

CA201 Value =value + 50 (LA1*2*6*50)

CA202 number = number + 1

CA203 Value =value + 50 (LA1*2*6*50)

CA204 number = number + 1

Line 6

PA1

PA101 = 6 (product number)

PA102 = (price)

PA107 = 0 (present)

PA2 (use PA7)

PA201 number = number + 1

PA202 value = value + 50 (LA1*2*6*50)

PA203 number = number + 1

PA204 value = value + 50 (LA1*2*6*50)

LA1 (use PA7)

LA101 = 2

LA102 = 6

LA103 = 50

LA104 number = number + 1

LA105 number = number + 1





PA7

PA701 = 6 (product number)
PA702 = CA (payment device)
PA703 = 2 (price list number)
PA704 = 50 (price)
PA705 number = number +1
PA706 value = value + 50
PA707 number = number +1
PA708 value = value + 50

› 5.2.3.15 Card Vend (Prices Lists) LIST 0 Example

list 0 line = 6 price=0.40
list 1 line = 6 price=0.30
list 2 line = 6 price=0.50
User makes selection list 0 line = 6 price = 0.40

VA1

VA101 value = value + 40 (LA1*0*6*40)
VA102 number = number + 1
VA103 value = value + 40 (LA1*0*6*40)
VA104 number = number + 1

DA2

DA201 Value =value + 40 (LA1*0*6*40)
DA202 number = number + 1
DA203 Value =value + 40 (LA1*0*6*40)
DA204 number = number + 1

Line 6

PA1

PA101 = 6 (product number)
PA102 = (price)
PA107 = 0 (present)

PA2 (use PA7)

PA201 number = number + 1
PA202 value = value + 40 (LA1*0*6*40)
PA203 number = number + 1
PA204 value = value + 40 (LA1*0*6*40)





LA1 (use PA7)

LA101 = 0
LA102 = 6
LA103 = 40
LA104 number = number + 1
LA105 number = number + 1

PA7

PA701 = 6 (product number)
PA702 = DA (payment device)
PA703 = 0 (price list number)
PA704 = 40 (price)
PA705 number = number +1
PA706 value = value + 40
PA707 number = number +1
PA708 value = value + 40

Card Vend LIST 1 Example

list 0 line = 6 price=0.40
list 1 line = 6 price=0.30
list 2 line = 6 price=0.50
User makes selection list 1 line = 6 price = 0.30

VA1

VA101 value = value + 30 (LA1*1*6***30**)
VA102 number = number + 1
VA103 value = value + 30 (LA1*1*6***30**)
VA104 number = number + 1

DA2

DA201 Value = value + 30 (LA1*1*6***30**)
DA202 number = number + 1
DA203 Value = value + 30 (LA1*1*6***30**)
DA204 number = number + 1

Line 6

PA1

PA101 = 6 (product number)
PA102 = (price)
PA107 = 0 (present)





PA2 (use PA7)

PA201 number = number + 1
PA202 value = value + 30 (LA1*1*6*30)
PA203 number = number + 1
PA204 value = value + 30 (LA1*1*6*30)

LA1 (use PA7)

LA101 = 1
LA102 = 6
LA103 = 30
LA104 number = number + 1
LA105 number = number + 1

PA7

PA701 = 6 (product number)
PA702 = DA (payment device)
PA703 = 1 (price list number)
PA704 = 30 (price)
PA705 number = number +1
PA706 value = value + 30
PA707 number = number +1
PA708 value = value + 30





Card Vend LIST 2 Example

list 0 line = 6 price=0.40

list 1 line = 6 price=0.30

list 2 line = 6 price=0.50

User makes selection list 2 line = 6 price = 0.50

VA1

VA101 value = value + 50 (LA1*2*6*50)

VA102 number = number + 1

VA103 value = value + 50 (LA1*2*6*50)

VA104 number = number + 1

DA2

DA201 Value = value + 50 (LA1*2*6*50)

DA202 number = number + 1

DA203 Value = value + 50 (LA1*2*6*50)

DA204 number = number + 1

Line 6

PA1

PA101 = 6 (product number)

PA102 = (price)

PA107 = 0 (present)

PA2 (use PA7)

PA201 number = number + 1

PA202 value = value + 50 (LA1*2*6*50)

PA203 number = number + 1

PA204 value = value + 50 (LA1*2*6*50)

LA1 (use PA7)

LA101 = 2

LA102 = 6

LA103 = 50

LA104 number = number + 1

LA105 number = number + 1





PA7

PA701 = 6 (product number)
PA702 = DA (payment device)
PA703 = 2 (price list number)
PA704 = 50 (price)
PA705 number = number + 1
PA706 value = value + 50
PA707 number = number + 1
PA708 value = value + 50

Value Token Vend (Prices Lists) LIST 0 Example

list 0 line = 6 price=0.40
list 1 line = 6 price=0.30
list 2 line = 6 price=0.50
User makes selection list 0 line = 6 price = 0.40

VA1

VA101 value = value + 40 (LA1*0*6*40)
VA102 number = number + 1
VA103 value = value + 40 (LA1*0*6*40)
VA104 number = number + 1

TA2

TA205 Value =value + 40 (LA1*0*6*40)
TA206 number = number + 1
TA207 Value =value + 40 (LA1*0*6*40)
TA208 number = number + 1

Line 6

PA1

PA101 =6 (product number)
PA102 = (price)
PA107 =0 (present)

PA2 (use PA7)

PA201 number = number + 1
PA202 value = value + 40 (LA1*0*6*40)
PA203 number = number + 1
PA204 value = value + 40 (LA1*0*6*40)





LA1 (use PA7)

LA101 = 0
LA102 = 6
LA103 = 40
LA104 number = number + 1
LA105 number = number + 1

PA7

PA701 = 6 (product number)
PA702 = TA (payment device)
PA703 = 0 (price list number)
PA704 = 40 (price)
PA705 number = number + 1
PA706 value = value + 40
PA707 number = number + 1
PA708 value = value + 40

**Value Token Vend
LIST 1 Example**

list 0 line = 6 price=0.40
list 1 line = 6 price=0.30
list 2 line = 6 price=0.50
User makes selection list 1 line = 6 price = 0.30

VA1

VA101 value = value + 30 (LA1*1*6***30**)
VA102 number = number + 1
VA103 value = value + 30 (LA1*1*6***30**)
VA104 number = number + 1

TA2

TA205 Value = value + 30 (LA1*1*6***30**)
TA206 number = number + 1
TA207 Value = value + 30 (LA1*1*6***30**)
TA208 number = number + 1

Line 6

PA1

PA101 = 6 (product number)
PA102 = (price)
PA107 = 0 (present)





PA2 (use PA7)

PA201 number = number + 1
PA202 value = value + 30 (LA1*1*6*30)
PA203 number = number + 1
PA204 value = value + 30 (LA1*1*6*30)

LA1 (use PA7)

LA101 = 1
LA102 = 6
LA103 = 30
LA104 number = number + 1
LA105 number = number + 1

PA7

PA701 = 6 (product number)
PA702 = TA (payment device)
PA703 = 1 (price list number)
PA704 = 30 (price)
PA705 number = number +1
PA706 value = value + 30
PA707 number = number +1
PA708 value = value + 30

**Value Token Vend
LIST 2 Example**

*list 0 line = 6 price=0.40
list 1 line = 6 price=0.30
list 2 line = 6 price=0.50
User makes selection list 2 line = 6 price = 0.50*

VA1

VA101 value = value + 50 (LA1*2*6*50)
VA102 number = number + 1
VA103 value = value + 50 (LA1*2*6*50)
VA104 number = number + 1

TA2

TA205 Value =value + 50 (LA1*2*6*50)
TA206 number = number + 1
TA207 Value =value + 50 (LA1*2*6*50)
TA208 number = number + 1

Line 6





PA1

PA101 = 6 (product number)

PA102 = (price)

PA107 = 0 (present)

PA2 (use PA7)

PA201 number = number + 1

PA202 value = value + 50 (LA1*2*6*50)

PA203 number = number + 1

PA204 value = value + 50 (LA1*2*6*50)

LA1 (use PA7)

LA101 = 2

LA102 = 6

LA103 = 50

LA104 number = number + 1

LA105 number = number + 1

PA7

PA701 = 6 (product number)

PA702 = TA (payment device)

PA703 = 2 (price list number)

PA704 = 50 (price)

PA705 number = number +1

PA706 value = value + 50

PA707 number = number +1

PA708 value = value + 50



5.2.4 Cash Examples

› 5.2.4.1 Fields Used In Examples

CA3, CA4, CA8, CA10, DA4, CA15

CA3*0*0*0*0*0*0*0

CA301	Value of cash in since last reset $CA301=CA302+CA303+CA309$ <i>(could use scaled version of CA304 instead of CA309, CA303 includes CA1001)</i>
CA302	value of coins sent to the cash-box since last reset
CA303	value of coins sent to tubes since last reset
CA304	value of bill accepted since last reset (bill count, Nb)
CA305	Value of cash in since initialization $CA305=CA306+CA307+CA310$ <i>(could use scaled version of CA308 instead of CA310, CA307 includes CA1002)</i>
CA306	value of coins sent to the cash-box since initialization
CA307	value of coins sent to tubes since initialization
CA308	value of bill accepted since initialization (bill count, Nb)
CA309	value of bill accepted since last reset (bill value, Nc)
CA310	value of bill accepted since initialization (bill value, Nc)

CA4*0*0*0*0

CA401	value of cash dispensed (payout + manually) since last reset
CA402	value of manual cash dispensed since last reset
CA403	value of cash dispensed (payout + manually) since initialization
CA404	value of manual cash dispensed since initialization

CA8*0*0

CA801	Value of cash overpay since last reset
CA802	Value of cash overpay since initialization

CA10*0*0

CA1001	Value of cash filled (manual fill tubes) since last reset
CA1002	Value of cash filled (manual fill tubes) since initial.

DA4*0*0

DA401	Value credited to all cards since initialization
DA402	Value credited to all cards since last reset

CA15*0

CA1501	Value of coin stored in all tubes of changer
--------	--





› 5.2.4.2 Changer Manual Fill Tubes

Insert into **tubes** 4 coins of 0.05 = 0.20

CA3

CA301 value = value + 20

CA303 value = value + 20

CA305 value = value + 20

CA307 value = value + 20

CA10

CA1001 value = value + 20

CA1002 value = value + 20

CA15

CA1501 value = value + 20

› 5.2.4.3 Changer Manual Fill Cash

Insert into **cash** 1 coin of 1.00

CA3

CA301 value = value + 100

CA302 value = value + 100

CA305 value = value + 100

CA306 value = value + 100

CA10

CA1001 value = value + 100

CA1002 value = value + 100





› 5.2.4.4 Changer Manual Dispensed

Dispense from **tubes** 2 coins of 0.05= 0.10

CA4

CA401 value = value + 10

CA402 value = value + 10

CA403 value = value + 10

CA404 value = value + 10

CA15

CA1501 value = value - 10

› 5.2.4.5 Insert Coin Into Cash-Box

Insert into **cash** 1 coin 1.00

CA3

CA301 value = value + 100

CA302 value = value + 100

CA305 value = value + 100

CA306 value = value + 100

› 5.2.4.6 Insert Coin Into Tubes

Insert into **tubes** 3 coins 0.10 = 0.30

CA3

CA301 value = value + 30

CA303 value = value + 30

CA305 value = value + 30

CA307 value = value + 30

CA15

CA1501 value = value + 30





› 5.2.4.7 Escrow (Dispensed Coins)

Dispense from **tubes** 3 coins 0.10 = 0.30

CA4

CA401 value = value + 30

CA403 value = value + 30

CA15

CA1501 value = value - 30

› 5.2.4.8 Overpay

Insert into **cash** 1 coin =1.00

vend price = 0.40

change payout = 0.50 (from tubes)

overpay = 0.10

CA3

CA301 value = value +100

CA302 value = value +100

CA305 value = value +100

CA306 value = value +100

CA4

CA401 value = value +50

CA403 value = value +50

CA8

CA801 value = value +10

CA802 value = value +10

CA15

CA1501 value = value - 50





› 5.2.4.9 Card Revalue

Insert into cash 1 coin 1.00 = 1.00
Insert into tubes 2 coins 0.10 = 0.20

CA3

CA301 value = value + 120
CA302 value = value + 100
CA303 value = value + 20
CA305 value = value + 120
CA306 value = value + 100
CA307 value = value + 20

DA4

DA401 value = value + 120
DA402 value = value + 120

CA15

CA1501 value = value + 20

› 5.2.4.10 Insert Banknote

Insert 1 banknote 5.00

CA3 (assumes ID401 is equal to 2)

CA301 value = value + 500
CA304 value = value + 5 (NO)
CA305 value = value + 500
CA308 value = value + 5 (NO)
CA309 value = value + 500
CA310 value = value + 500



5.3. APPLICATION NOTES FOR GENERAL ACCEPTED ACCOUNTING PRINCIPLES (GAAP)

5.3.1. Forward

Commonly in many countries from around 2010, a discussion to the security and tax government rules related to vending machines started. EVA-DTS has implemented this application note to show and clarify the usage of this standard with the existing vending machines to comply with such rules.

Most importantly for these rules is to:

- Ensure the correctness of data and a safe transfer of data
- Store single transactions and transactional sequences
- Ensure provable archives of data, where manipulation of data is not possible
- Hold provable archives of backoffice software and/or backoffice data derived from the machines raw data archives
- Do not allow cancellation of transactions or funds
- Implement recovery points for control calculation, i.e. daily funds statements

5.3.2. Source of Data

The Source of financial or tax related data is the vending machine (i.e. the vending machine controller or the coin changer or the cashless reader or whatever is decided to control the vends) and furthermore be written as **VMC-data**

As a vending machine is an automated system, unlike manual operated cash registers,

- there will never be a cancellation of vends,
- a daily funds statement will normally not be produced – instead it is done during the refilling action,
- a manual cash entry or cash removal is normally detectable



Nowadays, governments will no longer accept manual readouts – therefore EVA-DTS provides secure ways to transfer financial data from the vending machine to any possible data storage (like a handheld computer, a telemetry system, ...)

Data generation within the vending machine is strictly viewed as secure, because:

- The vending operation is programmatically tied to data generation
- It's tested and certified by the vending machine manufacturer (coin changer manufacturer etc.)

5.3.3. Transfer of Data

All Data is delivered as a file within EVA-DTS format. The transfer to a handheld can happen in either of two possible protocols (DEX/UCS or DDCMP).

Both Protocols divide the file contents in a number of data records, each record checked by a CRC-16 checksum and a block sequence number. Therefore, corrupted data files will never be accepted and saved.

Furthermore, if any other means of transfer is used (i.e. a telemetry system or simply writing data directly from the vending machine to a storage media like an SD-card), the whole file is secure with an overall CRC-16 sum within the G85-element.

Transferring this file of data to any storage media (handheld etc.) will furthermore be written as **"readout"**.

5.3.4. Transactional view

Most vending machines are not capable (due to limited storage space) to store each single vend as a single transaction. Therefore the mechanism within EVA-DTS is to use counters and this will be described in this chapter.

During the normal operation, a readout takes place when the machine is visited and refilled or i.e. the cashbox is emptied. From this point of view, a vending machine has just one transaction which equals a funds statement. The transaction itself may contain one or multiple vends.

Compared with a cash register, this is equal to a customer transaction, getting a receipt for i.e.





1 Trouser \$ 43,00
 2 Packs of Paper \$ 2,00
Total \$ 45,00

Date: 2014/08/12 12:34

Similar, one EVA-DTS readout would result in a transaction set of financial record like

Selection	Article	No.Vends	Total Value of Vends
01	Coke	45	45,00
02	Coke zero	23	27,60
....			
	Total	68	€72,60
Date			2014/08/12 12:34

This Transaction is "signed" with the EA3-elements, as every readout data and contains therewith a transaction date stamp with a reference to the previous transaction, fulfilling the requirements of GAAP.

5.3.5. Securing the archive

Fulfilling the requirements to transaction time stamps, EVA-DTS contains the elements in EA3 and ID1 as well as ID4. Even if the VMC is not equipped with a RTC (real time clock), EA3 may be filled with a readout time stamp received from the handheld (or other readout means). Therefore one transaction (readout) contains:

- an identification number for the vendor (ID101 and/or ID106),
- a currency information (ID4) ,
- a date and time field of this transaction (readout) (EA302 and EA303),
- a sequence number of this transaction (EA309 = number of reads done),



- a machine or person identifier, processing the readout (EA304),
- and the various number of vends and values,
- and a reference to the last readout (EA305 and EA306) by date and time,
- as well as a reference to the machine or person, processing the last readout (EA307)

Using this information, manipulation or modification of data like deleting transaction (readout) records or modifying identification numbers will result in broken transaction chains. Otherwise, doing such would need to fully modify the whole chain, including the numbers contained in this chain.

Similar to this transaction chain, each number contained in one data record (transaction) is secured by

- First of all, the G85 element,
- Secondly, the resettable and non-resettable counter or value

Modifying numbers needs to correct the G85 – sum (would be possible with some programming knowledge) – but additionally necessary would be a permanent correction of the non-resettable counters as well as the resettable counters in a mathematical correct way to lead to correct results over the whole transaction chain. Each new and not corrected readout would lead to discrepancies in not only one non-resettable counter.

5.3.6. Overcoming the technical limits

One common known problem to EVA-DTS, as well as other registers, is the limitation in numbers. Most vending machines use a microcontroller architecture, therefore the “number of vends” as well as the “value of vends” is limited to an “architectural based” maximum value, which may differ between various manufacturers. I.e. the number of vends could be a maximum value of 65535 or by another application a maximum value of 99999 or 4.294.967.295. These values are common limiting values, known as 16-bit or 32-bit max integer. The same limitation will rise for the value fields.

So consecutive readouts may result in a number of vend value of i.e. 65435, followed during next readout by a value of 31. This means – counter in vending machine has reached the limit and run over 0. Adding 65535 + 1 to the value of 31 results in the right value – 65567, resulting to the number of vends in this interval of 132 vends.



Obviously, due to the reference of last readout and the known limit numbers for each individual vendor, this is to calculate easily.

The elements ID102 up to ID103 as well as CB101 up to CB103 contain the information to the machine model and manufacturer (or if changer or cashless is used, the elements CA1 or DA1 or DB1), allowing to reference to the limit number from the manufacturers information.

5.3.7. Fault conditions

Sometimes, hardware will fail. This could result in readout not possible or due to other faults, VMC or change giver or cashless need to be replaced.

If readout is still possible, a final readout may be done. After this, VMC is exchanged and an initial readout is done (zero counters). As this took place, simply a new transaction chain starts, maybe with the same ID1 field or if appropriate, old ID1 is closed (deactivated) and new ID1 is activated.

If readout is not possible, with the exchange a new transaction chain starts, and one record has to be entered manually. This is a technical fault with manual interrogation – similar to cash registers and their recovery procedures. Obviously, government gets “nervous”, if technical fault is the standard procedure – but this should be the same for the operator itself.

5.3.8. Conclusive

Once EVA-DTS transaction records transmitted to the mobile device, handheld, or with other means to the back office, the back office work starts.

Within this, it would be good practice to archive the raw records as well as the calculation or summarizing records and secure the raw records i.e. by adding a digital signature, accepted by the local government authorities.

CHAPTER 6 - APPLICATION NOTES -



DDCMP

6.1 APPLICATION NOTES FOR THE ENHANCED DDCMP

This section of the document is intended to be read with Chapter 3, Data transfer using Enhanced DDCMP, and is an explanation and application guide to a number of points.

When reading this chapter it should be noted that it is purely advisory in nature and in no part substitutes for the actual standard which is fully defined in Chapter 3.

All chapter, section, subsection etc. numbers in this section of the document refer to the above mentioned chapter.

6.1.1 Byte Format (see 3.4.1.2 and 3.6.4.1.1)

There are several conventions used in current applications, when transmitting fixed size Binary Data without explicit delimiters. These are highlighted in the table below.

Data Type	Transfer Order
Multi – Byte Values	Transmitted least significant byte first, unless described otherwise.
Date Value	Transmitted as a three byte value, held in binary coded decimal, (i.e. 2 digits per byte), in the order DDMMYY .
Time Value	Transmitted as a three-byte value, held in binary coded decimal form in the order hhmms .
Security Codes	Transmitted as a four-byte value ms byte first. With reference to 3.6.4.1.1, the order is S2S1 P2P1 .
User Identity	Transmitted as a two-byte value ms byte first in alphanumeric format.
Machine Serial Number	Transmitted as an 8-bit ASCII string with the most significant digit first. For the ASCII format see 2.3.2.



6.1.2 Cyclic Redundancy Check (see 3.4.5)

It is recommended that the CRC be calculated cumulatively between successive characters being received. This means that the actual CRC could be calculated within one character's transmission time of the end of the block, thus considerably speeding up the interval between blocks.

Sample CRC routines in C, 6800 Assembler and 8051 Assembler are shown below:

C Routine for CRC

```
#include <stdio.h>

void calc_crc(unsigned int *pCrc, unsigned char uData)
{int iBit;
for (iBit = 0;iBit<8;iBit++,uData>>=1)
{if((uData^*pCrc)&0x01)
{*pCrc>>=1;
*pCrc^=0xA001;}}
else
*pCrc>>=1;}}
```





6803 Assembler

Notes: Index points to DATA, CRC is a 16 bit variable, COUNT is an 8 bit variable.

	LDAB	#08	
	STAB	COUNT	
	LDD	CRC	
	EORB	X	; first XOR with Data
CRCLP :	LSRD		; 8bit shift right
	BCC	CRCEQ	
	EORA	#\$C0H	
	EORB	#\$02	
CRCEQ :	DEC	COUNT	
	BNE	CRCLP	





8051 Assembler

Notes: R1 points to DATA, CRC is held in R3, R2.

```

MOV      R0 , #08      ; loop Counter
MOV      A , R2        ; low Byte CRC
XRL      A , @R1       ; first XOR with Data
MOV      R2 , A
CRCLP :  MOV      A , R3        ; high Byte CRC
CLR      C
RRC      A
MOV      R3 , A
MOV      A , R2        ; low Byte CRC
RRC      A
MOV      R2 , A
JNC      CRCEQ
XRL      A , #02
MOV      R2 , A
MOV      A , R3
XRL      A , #0C0H
MOV      R3 , A
CRCEQ :  DJNZ     R0 , CRCLP
```



6.1.3 Enhanced DDCMP Features

Communication between the Master and Slave has the following variation to standard DDCMP features:

- One of the flags (bit 7 of the third byte – the select flag) in the header for data messages has been used as a 'Last Message' flag. The purpose of this is for the station transmitting a data message to indicate that the right to transmit a data message may be transferred to the other station on completion of the current message. This is used, for example, to allow the Master to transmit the audit data as a sequence of data messages each with the select flag cleared except in the last one.

Current implementations of the Enhanced DDCMP have to take notice of the value of the select flag. Old implementations of the protocol do not take any notice of the value of the select flag, although it should be noted that the value of the flag might alter according to which activity is in progress at which point in the system.

Thus the Data Carrier communications with the vending machine may not toggle the flag, whilst those between the PC and the Data Carrier may toggle the flag.





6.1.4 Command Messages & Responses

› 6.4.4.1 Read Data

A diagram showing the reading of lists is shown below.

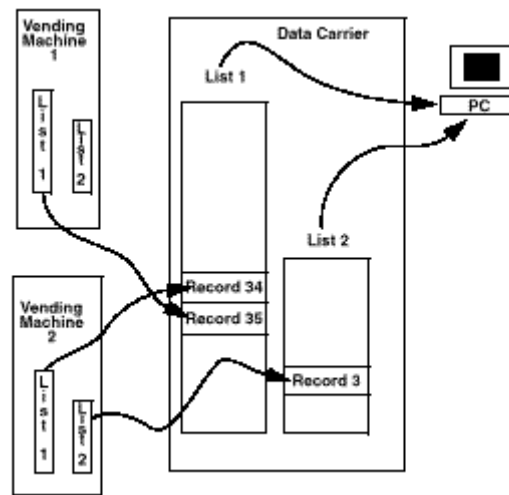

The Vending Machine may contain data in a common pool that can be accessed in a number of ways by means of different list numbers. In some cases a data element may be accessed through a number of different lists.

The diagram above shows how the data in list1 of the first machine is transferred to the collection of list1 records in the Data Carrier, for onward transfer to the PC later.

On visiting Machine 2, the Data Carrier collects 2 lists and stores these as records in the appropriate collections of lists.

The transfer to the PC takes place and the lists within the Data Carrier are moved, record by record onto the PC. Within the protocol it is possible to request List 1, Record 34. However in practice, one asks for all records to be transferred at once.





› 6.1.4.2 Delete Data (see 3.6.4.1.5)

This command is used at the end of a data transfer from the Data Carrier to the PC to allow the PC to indicate to the Data Carrier that the records have both been transferred and stored safely. The Data Carrier then marks the transferred information as being disposable but does not actually delete the data until the space is needed. This allows the PC to re-read the information into a different file, or allows the user to restart the whole process with another PC in case of damage or file corruption of the first copy of the transferred data.

6.1.5 Message Sequences - End of Communications Sequence (see 3.6.4.1.8)

In the pre December 1990 implementation of the optical link it is possible under an Operator induced fault condition to cease transmission without successfully resetting the interims within the Vending Machine. This then results in the values being reported again next week before being reset. The Totals are not affected by the Operator induced fault.

The present implementation sends an ACK + FINISH at the end of the sequence and after the last data message. If the Operator has removed the Data Collector from the vicinity of the Vending Machine before these have been received, then the Interims are not reset. The Data Collector is unaware that the Interims have not been reset due to an incomplete communication session.

The agreed solution is to have the Vending Machine acknowledge the receipt of the FINISH command by sending an ACK to the Data Carrier. The Vending Machine marks the data as ready to reset & resets it at the next paid vend. The Data Carrier transfers the list just received from a Pending List to the true list on receipt of the ACK. This can be illustrated:

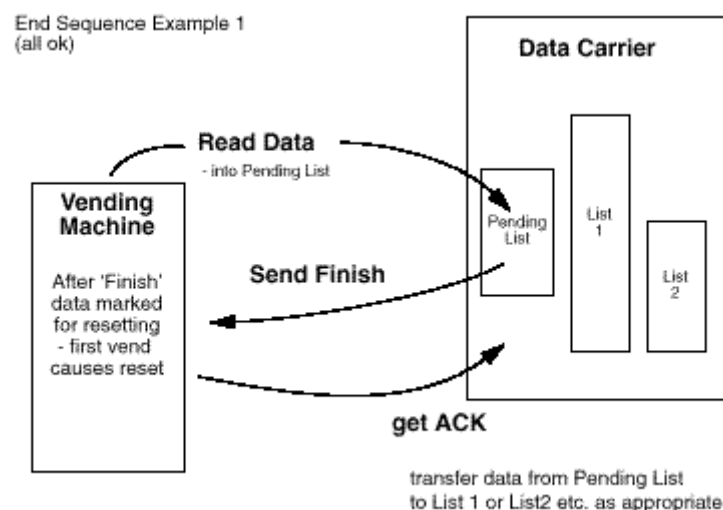

6.1.6 Security-Passcode usage

During each session request within eDDCMP, a security mechanism is built in to prevent unauthorized readout/configuration. This is done during the "Who are you - WAY accepted" sequence.

The mechanism needs a 4 byte binary security code store in the slave device, which is split for definition purposes into 2 byte security and 2 byte passcode. When the master asks for connection, the slave compares the masters' transmitted 4 byte security word against its stored value and grants access only when the two match.

The commonly installed mechanism for setting the slaves code is as follows:

- § A newly manufactured slave has a 4 byte zero value set. A zero value grants access on every requested code.
- § If the requested code is not zero, the slave grants access and stores the requested code immediately as the new code.
- § Further requests only gain access with this newly set code.

Any further configuration transmission (WRITE DATA) that contains an SD1 element may overwrite the stored code. The code is used in binary form within the DDCMP protocol message and sent in ASCII form via the SD1 element, so a conversion is required between the two forms. The following defined conversion algorithm should be used if the first character of the SD101 or SD102 element starts with uppercase ASCII letter 'X', otherwise the conversion algorithm is manufacturer specific.

The value (32 bit, i.e. 4 byte number) is represented in HEX ASCII form (with all alpha characters in uppercase) e.g. HEX value 01 02 03 04 (which corresponds to a decimal value of 16909060) is represented by "X01020304" hence a password of 01 02 03 04 can be changed to a new password AA 00 EF 21 by sending the following message SD1*X01020304*XAA00EF21, where the format is MS Byte first i.e. 0x58('X'), 0xAA, 0x00, 0xEF and 0x21.

Note: All new products should support the defined algorithm but data carriers should be aware of and support earlier implementations that have manufacturer specific algorithms.



6.1.7 Configuration features

To avoid any unauthorised setting of configuration data, it is common for vending machine controllers to use other methods as well as checking the pass/security code.

Essentially, the Security/passcode matching is sufficient for any readout of data, but when configuring the settings, controllers also check whether the door is open at the same time. This can be done either by using a door switch or by the pressing of internal function keys on the controller.

6.1.8 Slave address setting

Each device using enhanced DDCMP has a default slave address set. There must be a mechanism built in to each device, to allow the changing of the slave address from default to one of the individual free addresses. This is in the event that more than one device in the system is using the same address.

6.2 EXAMPLE COMMUNICATION SEQUENCES

This section of the application notes will show examples of various common message sequences as well as erroneous sequences and how to handle them.



6.2.1 Standard Data Collection Examples

The most common form of Data Collection is Audit collection. This is generally used on a periodic (weekly) basis to keep the Vending Machine configuration settings up to date and to acquire any data generated by the machine since the last Audit Collection. This activity will usually be carried out by the Route Person as part of their routine visit to the machine. All Interims, i.e. resettable values, are reset to zero after such a collection, on the first vend completed after a FINISH is received by the Vending Machine.

The type of data collection is set by the list number, with Audit collection being list number 1. Other possible forms of Data Collection are :

- Security Collection (List No. 2)
- Machine Configuration List (List No. 64)
- Dump List (List No. 50)

Note that, with the exception of START, STACK, ACK and NACK messages, all messages are formed using a Data Message Header together with the necessary command / data suffixes. For example, a Finish command with header would be sent as follows:

```
81 02 40 05 03 01 A3 20 77 FF 67 B0
```

where

- the first 8 bytes are the Message Header (see section 3.6.3).
- the last 4 bytes are the actual FINISH command (See section 3.6.4.1.8).

The following examples show several standard message sequences for Audit with and without configuration, assuming error free transmission of all messages. In all of the these examples, where Rx and Tx numbers are shown, these refer to the sequence numbers in the Data Header (see 3.6.3) and the ACK and NACK (3.6.2) messages. These counts are maintained by both the transmitting and receiving stations.





6.2.1.1 Link Initialization

N.B.The Who Are You message is rejected by the slave if the Security and Pass codes in the message do not match those within the slave device.

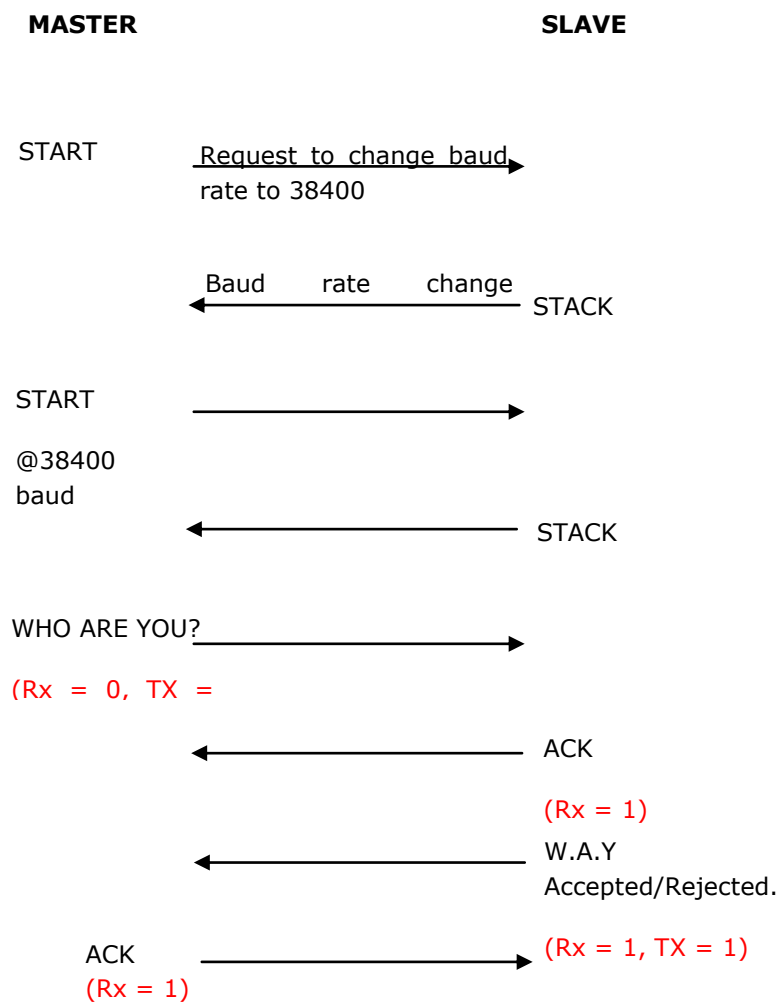



› 6.2.1.2 Data Collection

In the sequence below the data obtained depends on the list number X, which can be 1,2, 50 or 64 as described in section 6.2.1.

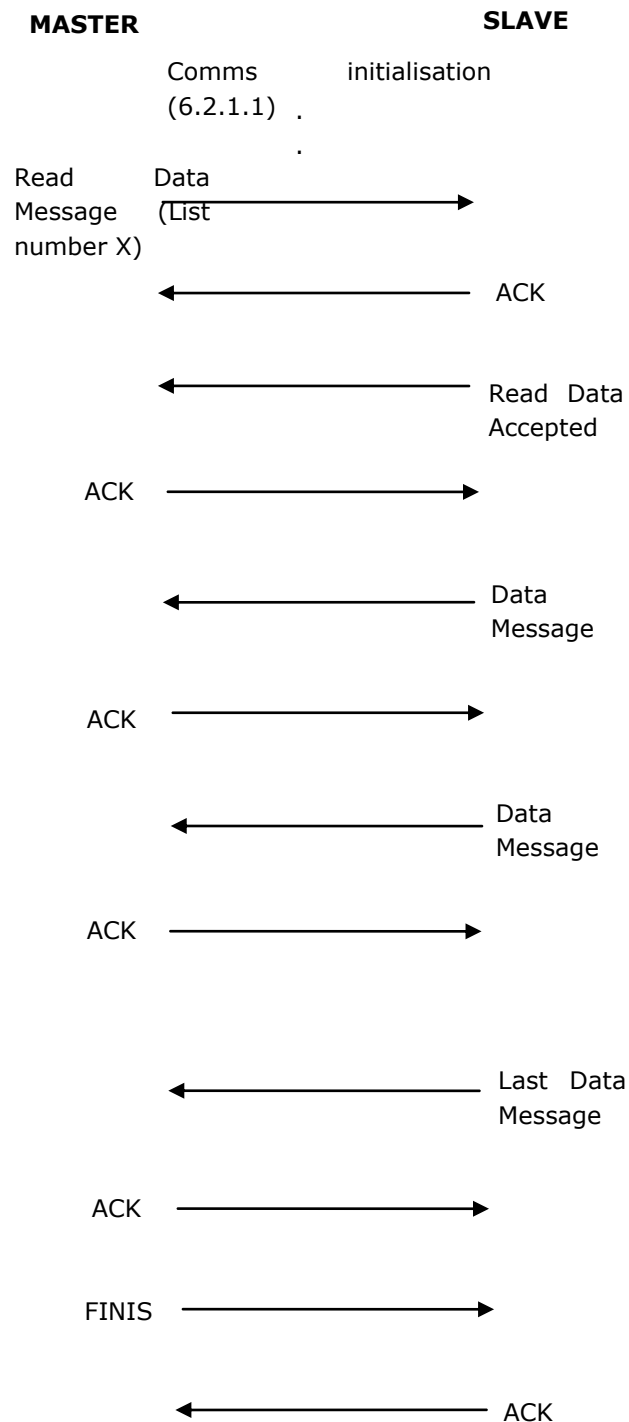



› 6.2.1.3 Audit Collection with Configuration

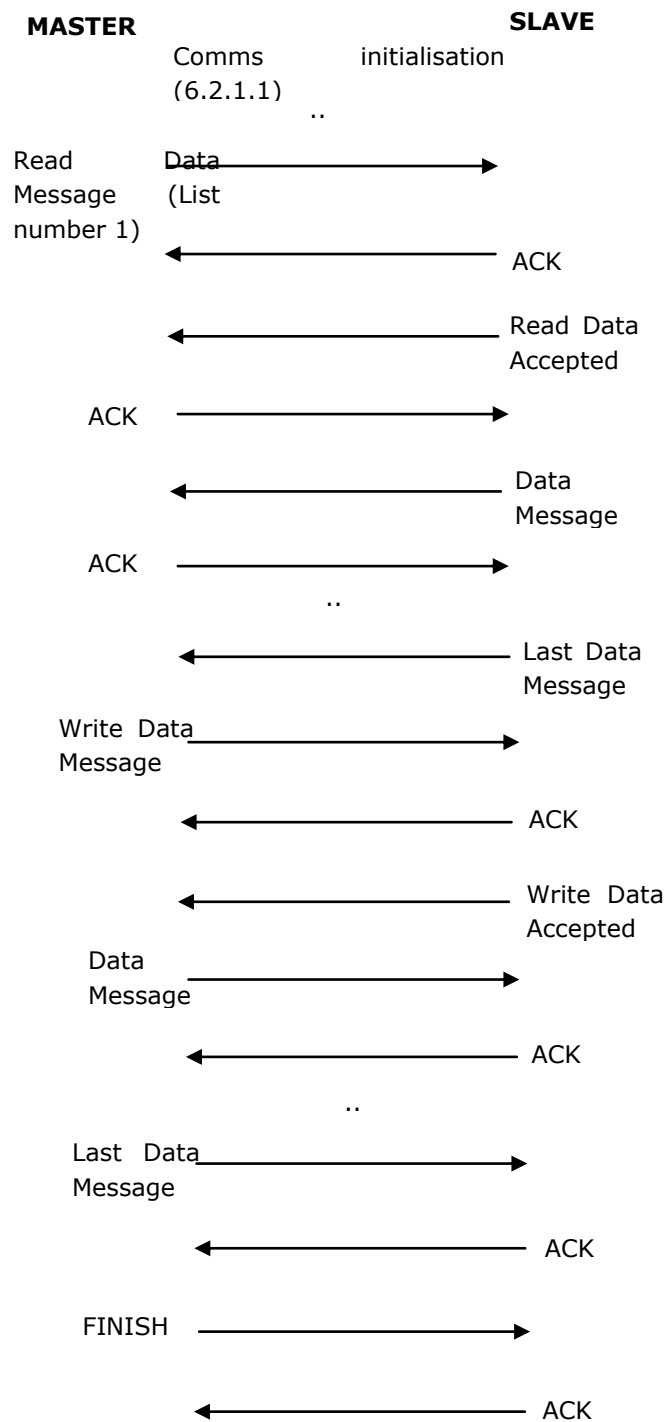



› 6.2.1.4 Configuration with consecutive Audit Collection

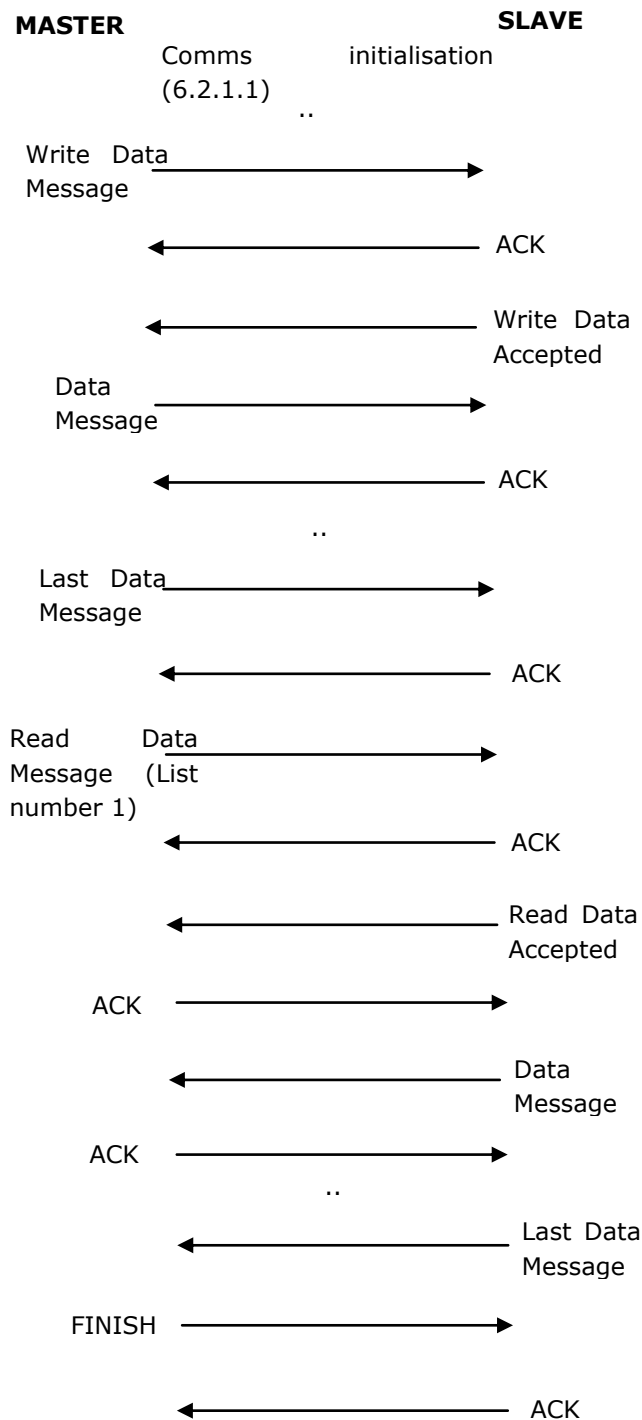

› 6.2.1.5 Program Slave Device

Program Slave Device, with its optional Configuration is generally used only on installation of the Vending Machine. The PSD data: Date, Time, Interrogator ID, machine serial number must be stored in the machine, rewriting any previous stored value. This activity will usually be carried out by the Installation Engineer as part of their setting up of the machine.

If the serial numbers match, then the message is accepted, otherwise it is rejected.

N.B It is also possible to configure data in the same session.

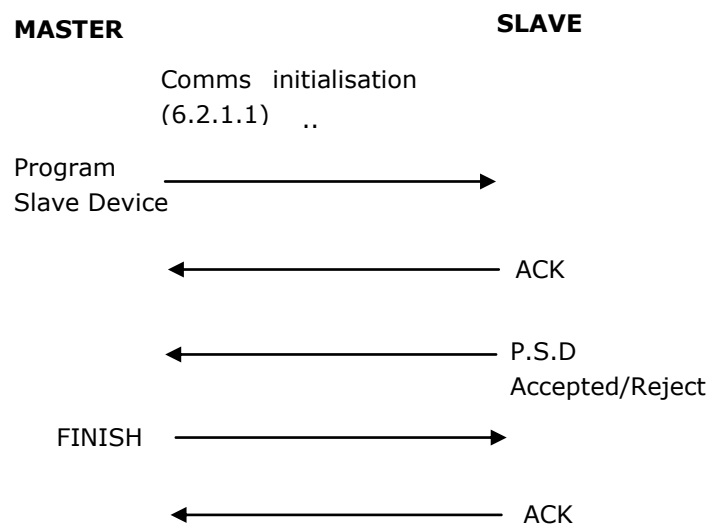

› 6.2.1.6 Security Collection

Security collection, although infrequently used, takes a 'snapshot' of the Vending Machine settings and data generated by the machine since the last Audit Collection. This activity will usually be carried out by the Route Supervisor as part of a special visit to the machine. All Interims, i.e. resettable values are left unchanged after such a collection.

Basically, the only difference between this and an audit collection is the list number therefore simply substitute 2 for X in the diagram shown in 6.2.1.2.

› 6.2.1.6 Dump list collection

Dump list is the collection of all data stored in the machine needed to make a copy of the machine itself, for example before changing the CPU board, or to set-up equal machines at the end of the production line. For example, a dump list can be built by chaining together audit list and configuration data. Collecting a dump list is the same as the data collection shown in 6.2.1.2, substituting 50 for X.





› 6.2.1.8 Extra read example

The example below shows that more than one list can be read from the product in the same session by setting the extra read byte to the number of extra reads required, in the Who are You response.

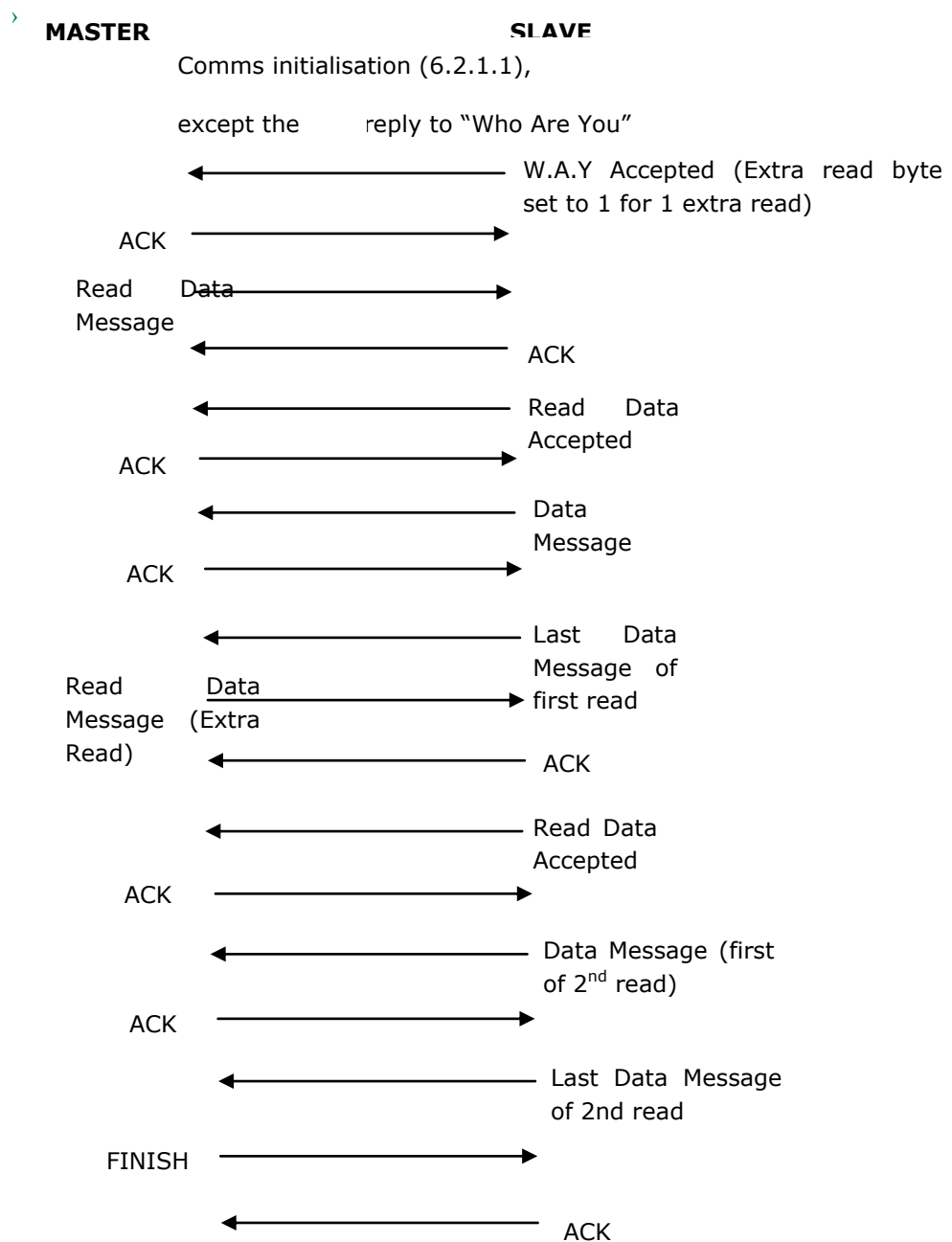

› 6.2.1.9 Select flag example

The select flag is used when the length of data being read by the master is unknown. The master sets the record length field to 0 and then continues to read data blocks until it sees that the select flag is set at which point it can finish the session as all data has been read.

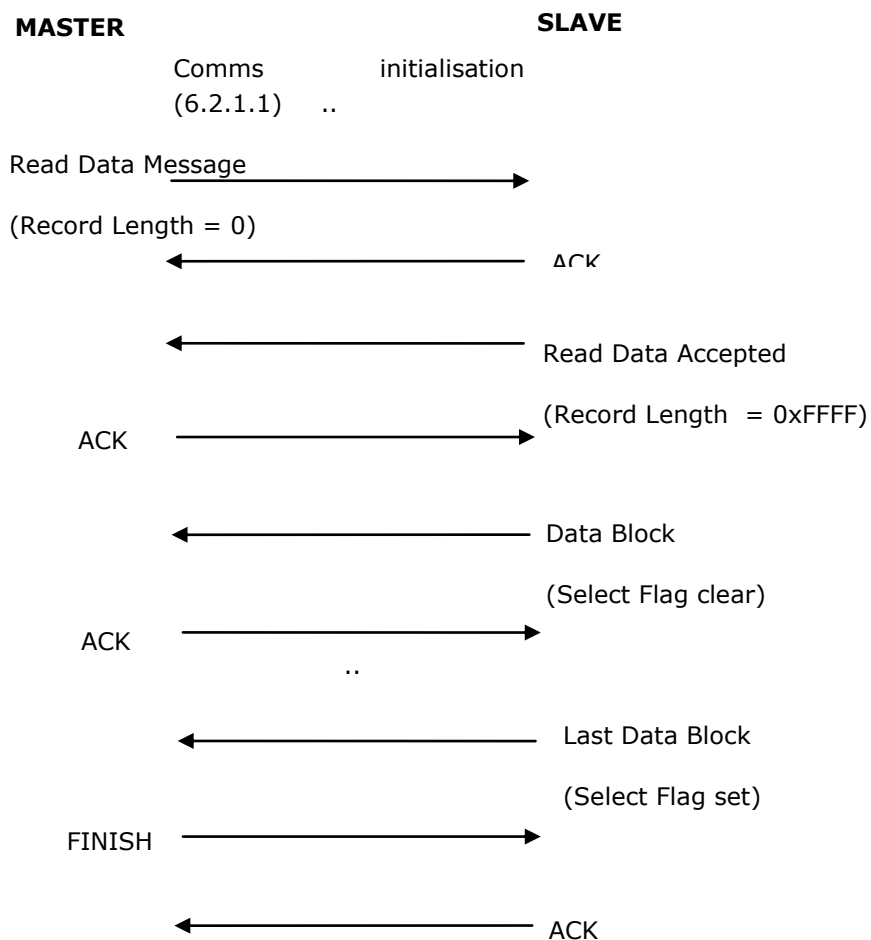



6.2.2 Error Handling Sequences

The examples shown below try and show the sequence of messages required to try and recover an error on the link.

Again, in all of the these examples, where Rx and Tx numbers are shown, these refer to the sequence numbers in the Data Header (see 3.6.3) and the ACK and NACK (3.6.2) messages.

› 6.2.2.1 Corrupt ACK received by the Transmitting Station

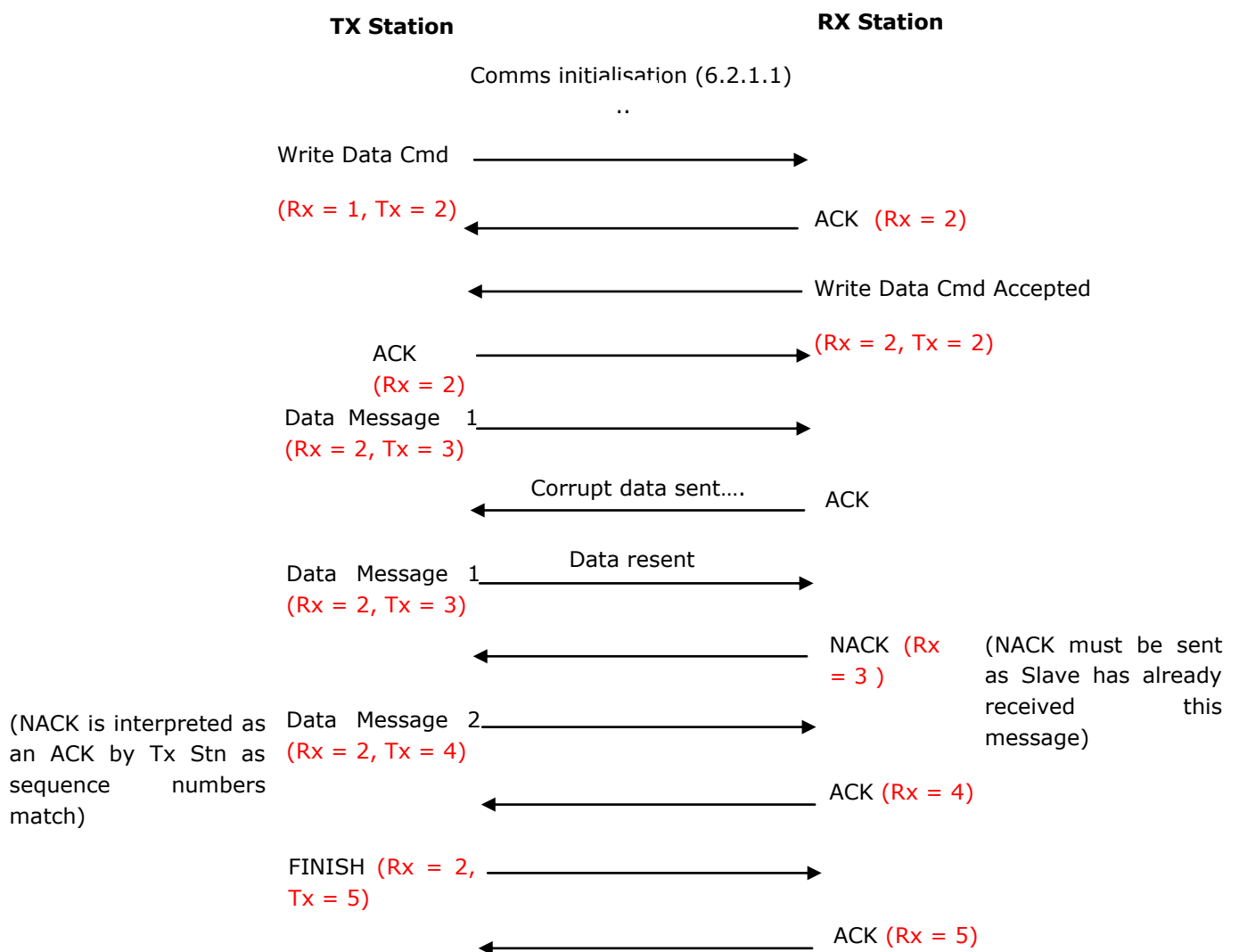

› 6.2.2.2 Corrupt data received by the Receiving Station

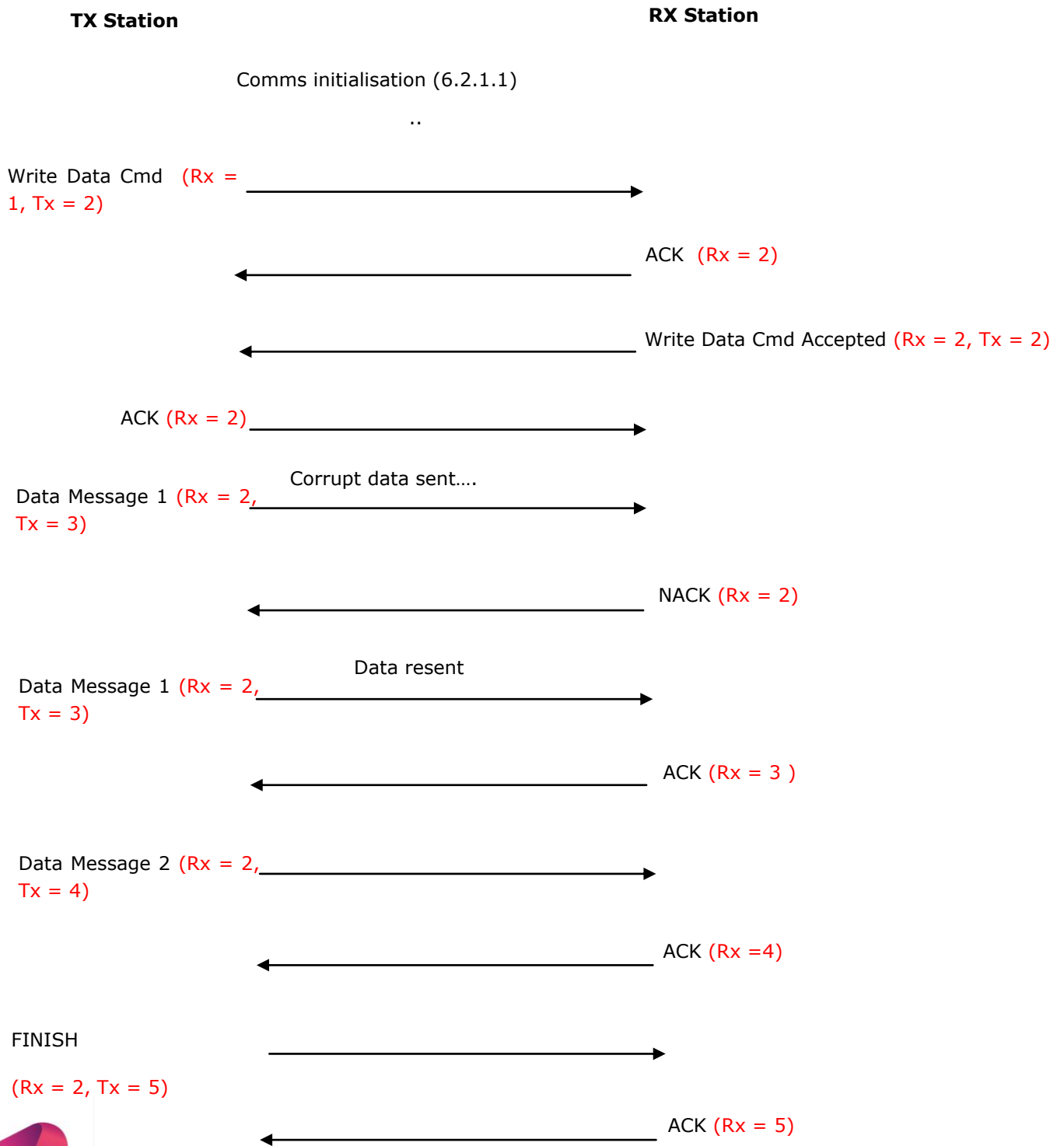



› 6.2.2.3 Transfer with lost synchronisation

In the event that the slave receives more than one corrupt packet without receiving a valid packet in between, it should not respond after it has sent the NACK to the 1st corrupt packet.

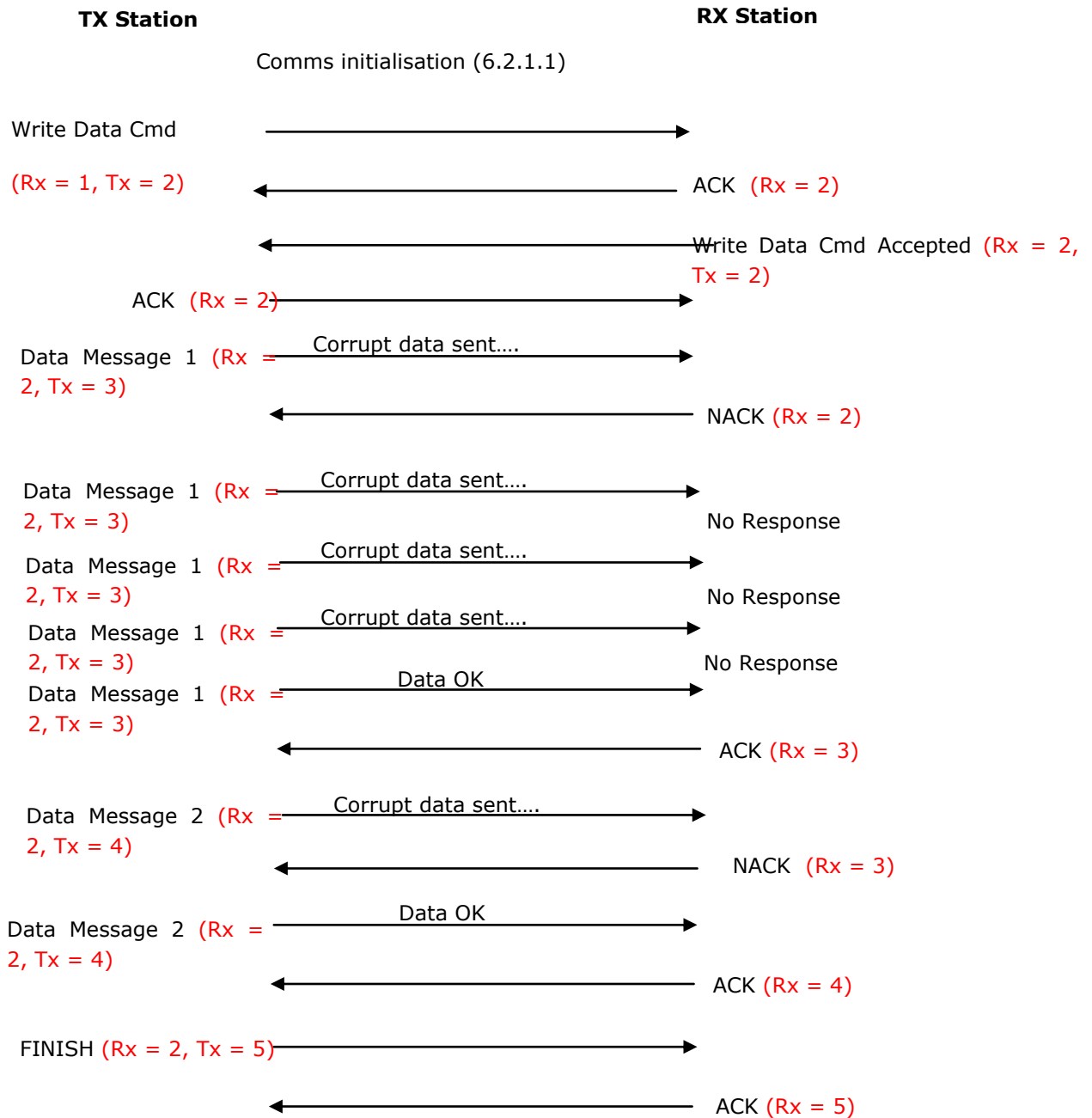

> 6.2.2.4 Retry mechanism

This sequence shows what should occur when the maximum number of retries has been reached.

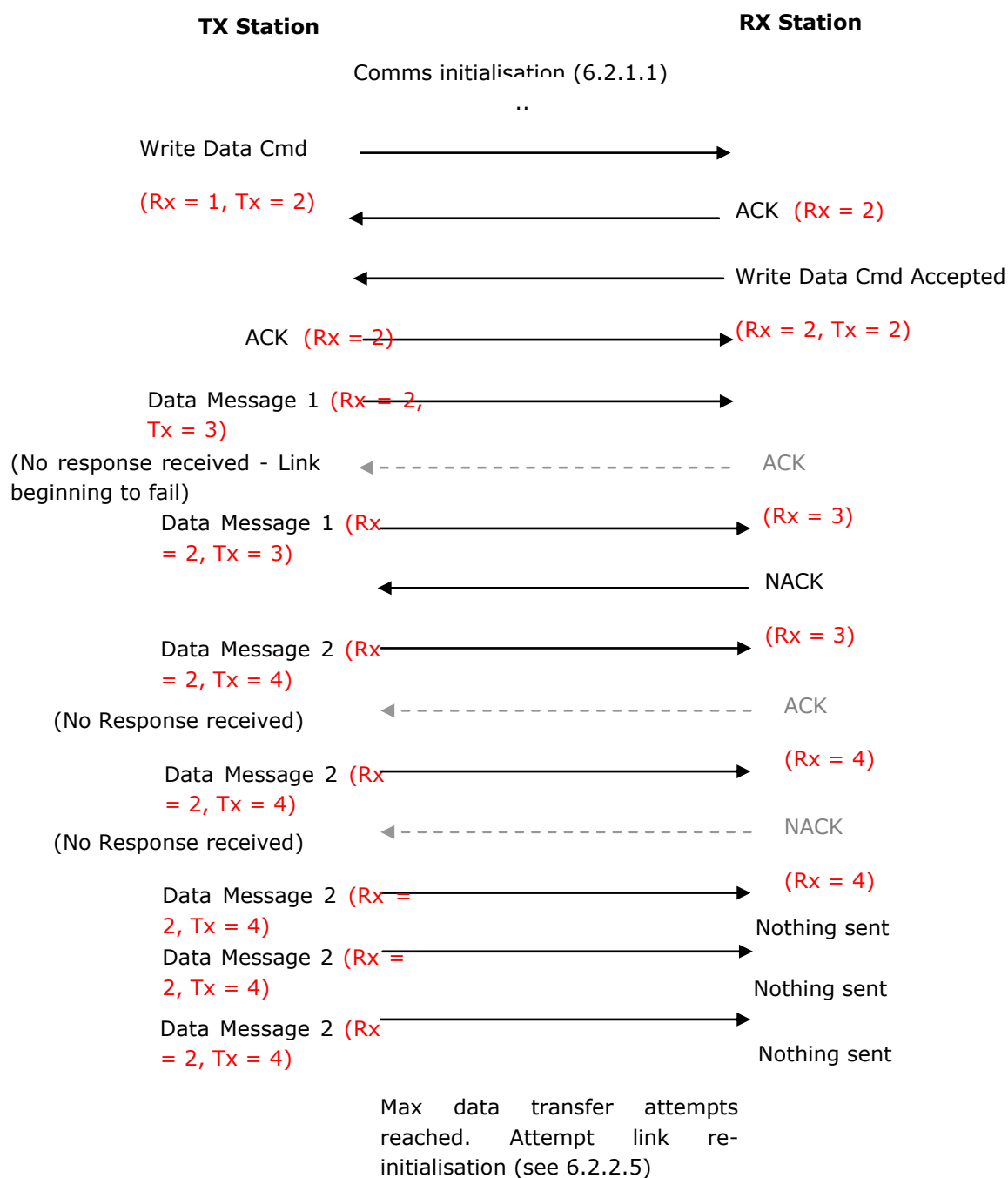

› 6.2.2.5 Link Reinitialisation

Once the maximum number of retries has been reached, the master should try to re-initialise the link as shown below. Frame sequence numbers must be reset as described in 3.6.2.

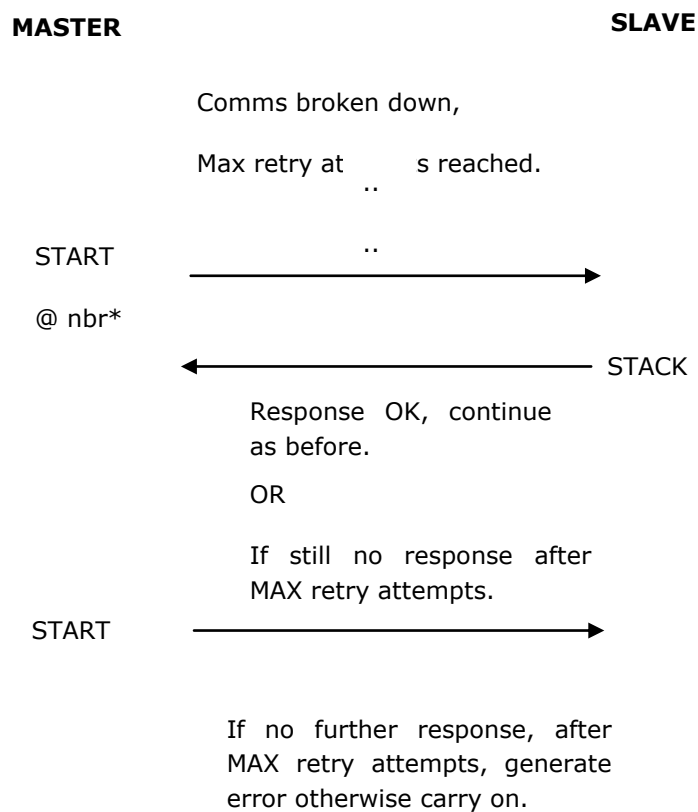

* - nbr: negotiated baud rate, if baud rate has been successfully changed to other than 2400. If not then only max retry attempts at 2400 can be attempted.





› 6.2.2.6 "Piggy Back" ACK.

In the event that the ACK message is either corrupt or never received, then provided there are no errors in the header of the next data message can be interpreted as an ACK to the previous message, as shown below.

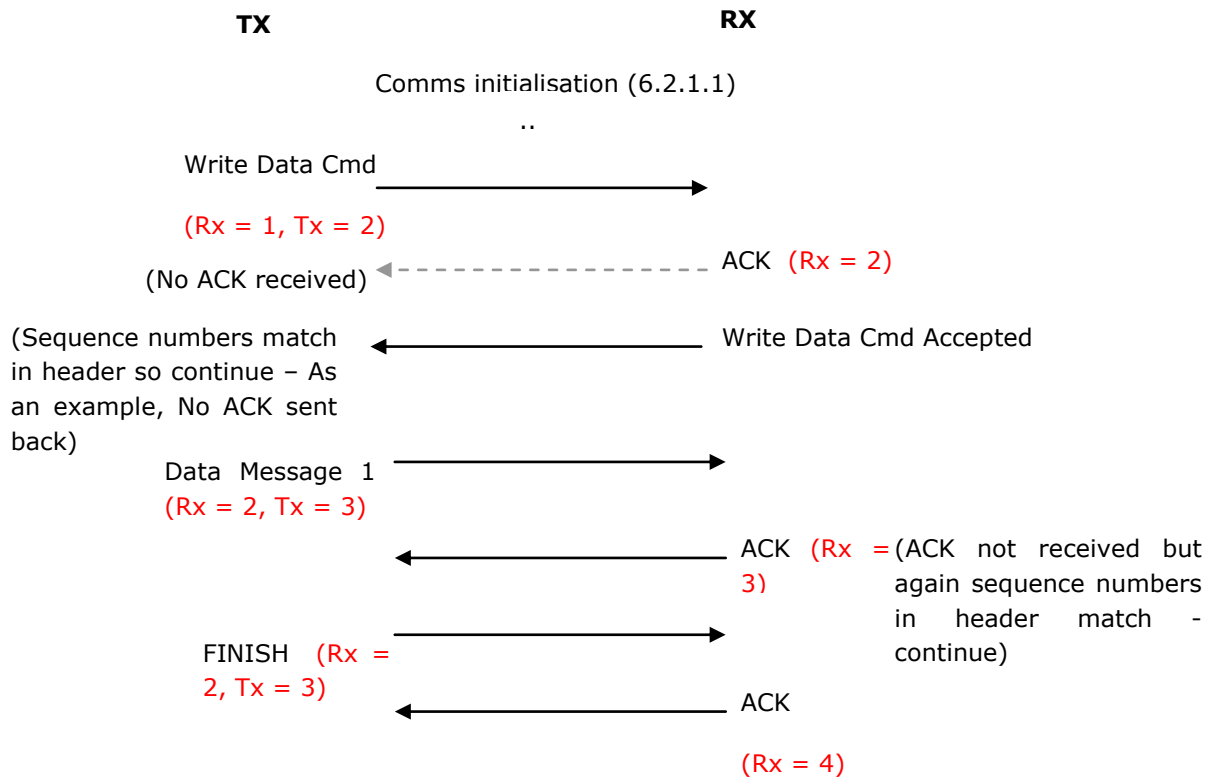



CHAPTER 7 - DATA TRANSFER PHYSICAL LAYERS

7.1 SCOPE

This specification defines physical layers used for the interchange of data between two units in the vending environment. The actual eDDCMP and DEX/UCS protocols are specified in previous chapters of the EVA-DTS.

7.2 OVERVIEW

The medium for the vending audit or configuration data transfer is currently based on two physical interfaces.

- Direct connected hardware
- IrDA based optics

Throughout this chapter reference will be made to three specific types of electronic devices as defined below:

- Vending Machine Device (VMD) - refers to the actual device in the vending machine that monitors the various transactions and assimilates the audit data. Examples of targets are vending machine control boards, coin mechanisms, cashless readers, audit devices, etc.
- Data Carrier (DC) - refers to the actual device that interrogates or configures the VMD. Examples are hand held terminals, portable computers, radio telemetry systems, cellular systems, etc.
- Business System Computer (BSC) - refers to the higher level computer system that the DCs upload with their collected data from the VMD or receive configuration/setup information. Examples are mainframes, minis, personal computers, etc.





7.3 HARDWIRED PHYSICAL LEVEL DETAILS

The hardwired interface is based on a three wire electrical cable using 1/4" audio (stereo) type jacks and plugs. All 1/4" audio (stereo) connectors, both male and female, shall be in accordance with Electronics Industry Alliance (EIA) standard. Standard RS232C bipolar electrical signal levels are used with the EXCEPTION that the Vending Machine Device may transmit using TTL unipolar (0 to + 5VDC) signal levels.

The following subsections are provided for further clarification for the vending industry.

7.3.1 Vending Machine Device (VMD)

The VMD (control boards, coin mechanisms, audit devices, etc.) in the vending machine shall be equipped with a 1/4", three circuit, EIA compliant female audio (stereo) socket with the pin assignments per below:

- **Tip - transmit data from VMD**
- **Ring - receive data to VMD**
- **Sleeve - signal ground**

The VMD shall be capable of receiving data via RS-232C bipolar signal levels or TTL unipolar signal levels (0 to + 5VDC). Transmission of data shall be via RS232C bipolar signal levels or, as TTL unipolar signal levels (0 to + 5VDC).

The VMD should be capable of automatically detecting the connection of a Data Carrier. This can be done by either sensing the insertion of the DC's plug and/or the initiation of Session Level character transmission.

It is recommended that the socket in the VMD be mounted in a convenient location that is readily accessible for connection of the Data Carrier's plug.



7.3.2 Data Carrier (DC)

The Data Carrier (hand-held terminal, PDA, PC laptop, telemetry system, etc.) shall be equipped with a 1/4", three circuit, EIA compliant male audio (stereo) plug, typically on the end of a cable, with the pin assignments per below. Also shown are the corresponding connections to standard PC serial port DB-9 and DB-25 connectors.

- | | | |
|---------------------------------------|----------------|-----------------|
| ▪ Tip - receive data to DC | DB9 – 2 | DB25 – 3 |
| ▪ Ring - transmit data from DC | DB9 – 3 | DB25 – 2 |
| ▪ Sleeve - signal ground | DB9 – 5 | DB25 – 7 |

The DC shall be capable of receiving data via RS-232C bipolar signal levels or TTL unipolar signal levels of 0 to +5VDC automatically. Transmission of data shall be via RS-232C bipolar signal levels.

Due to the serial communication resources and designs of many existing VMDs, it is a requirement of Data Carriers to disconnect from a VMD after a data transfer session. This can be performed either by physically disconnecting or electronically setting its transmit signal to a high impedance state. In essence, the VMD must detect that the DC is no longer present. Disconnecting will typically result in the VMD returning to its normal vending operation. To allow the VMD error or critical event reporting to occur, permanently attached Data Carriers (i.e., telemetry devices) must keep their receive signal connected.

7.3.3 Business System Computer (BSC)

If the Business System Computer transfers audit / configuration data via the eDDCMP or DEX/UCS protocol, it shall be equipped with a 1/4", three circuit, EIA compliant female audio (stereo) socket, typically on the end of a cable, with the pin assignments per below. Also shown are the corresponding connections to a standard PC serial port DB-9 and DB-25 connectors.

- | | | |
|---------------------------------------|----------------|-----------------|
| ▪ Tip - transmit data from BSC | DB9 – 3 | DB25 – 2 |
| ▪ Ring - receive data to BSC | DB9 – 2 | DB25 – 3 |
| ▪ Sleeve - signal ground | DB9 – 5 | DB25 – 7 |

The computer shall be capable of receiving and transmitting data via RS-232C bipolar signal levels.



7.4 OPTICAL IrDA PHYSICAL LEVEL DETAILS

The optical Link is IrDA-1.0 compatible at the physical layer only. For more detailed information refer to the IrDA Physical Signaling Layer Specification, which can be found on the IrDA web site, www.irda.org.

7.4.1 Optical Characteristics

The following optical characteristics shall apply when operating the optical link at 25°C:

› 7.4.1.1 Peak Wavelength

The wavelength of the transmitter at maximum output shall be 850-900 nanometres (nm).

The wavelength of the receiver shall be 850-900 nm. (The receiver sensitivity at 800 nm and 1100 nm may be reduced to 50% of the peak sensitivity if compatibility with old applications is necessary).

› 7.4.1.2 Intensity in angular range

The radiant intensity within a 30° cone (total angle) centred on the optical axis of the transmitter shall be not less than 40 mW / sr whilst the transmitter is emitting light and be less than 500 mW/sr. (A lens or reflector may be used in conjunction with the source to meet this specification.)

› 7.4.1.3 Half power angle shall be in a range from +/-15 to +/-30 °.

› 7.4.1.4 Transmitter rise time (10-90%) Must be less than 0.6 usec.



- › 7.4.1.5 Optical overshoot must be less than 25 %.
- › 7.4.1.6 Receiver incidence in angular range Must be between 40 up to $5 \cdot 10^6$ MW/m².
- › 7.4.1.7 Receiver half power angle must be more than +/-15°.
- › 7.4.1.8 Ambient Illumination(Not an IrDA spec, but recommended values for Vending operation)

The optical link shall operate in accordance with this specification when subjected to one of the following ambient illuminations:

Open shade ambient light environment.

This shall be a solar radiation which may reach 1000 watts per square metre integrated over the band 800 to 1000 nanometres.

The realistic maximum value will be 500 watts per square metre.

Indoors Illumination 50/100 Hz, 60/120 Hz.

This shall be fluorescent illumination of less than 100 watts per square metre integrated over the band 800 to 1000 nanometres.

- › 7.4.1.9 Optical Filtering (not in IrDA spec)

It is permitted to use an infra red optical filter to improve the transmission characteristics of the link.



› 7.4.1.10 Optical Modulation

The modulation of the optical signal shall be as follows:

Modulation method: Send one optical pulse for a logical '1' signal and no optical pulses for a logical '0'.

Modulation description: according to IrDA (1.41us or 3/16 baud rate)

Pulse Width at 9600 baud:1.41 us up to 22.12 us (which is 3/16 of baud rate time)

Pulse Width at 115,200 baud:1.41 us up to 2.71 us (which is 3/16 of baud rate time)

7.4.2 Receiver Characteristics

The maximum distance over which data can be transmitted is 1m.

7.4.3 Physical Separation of Optics (not IrDA, but recommended values for vending operation)

The source and detector components and circuits shall be selected and designed to match the optical characteristics defined in section 3.1 such that satisfactory transfer of data shall occur whenever:

- The separation between source and detector on the one unit (one of either the Data Carrier or the Vending Machine Device) shall not exceed 20mm optical centre to optical centre
- The angles made between a straight line from source to detector and the optical axes of the source and detector do not exceed thirty degrees (30°)





The physical separation is illustrated below.

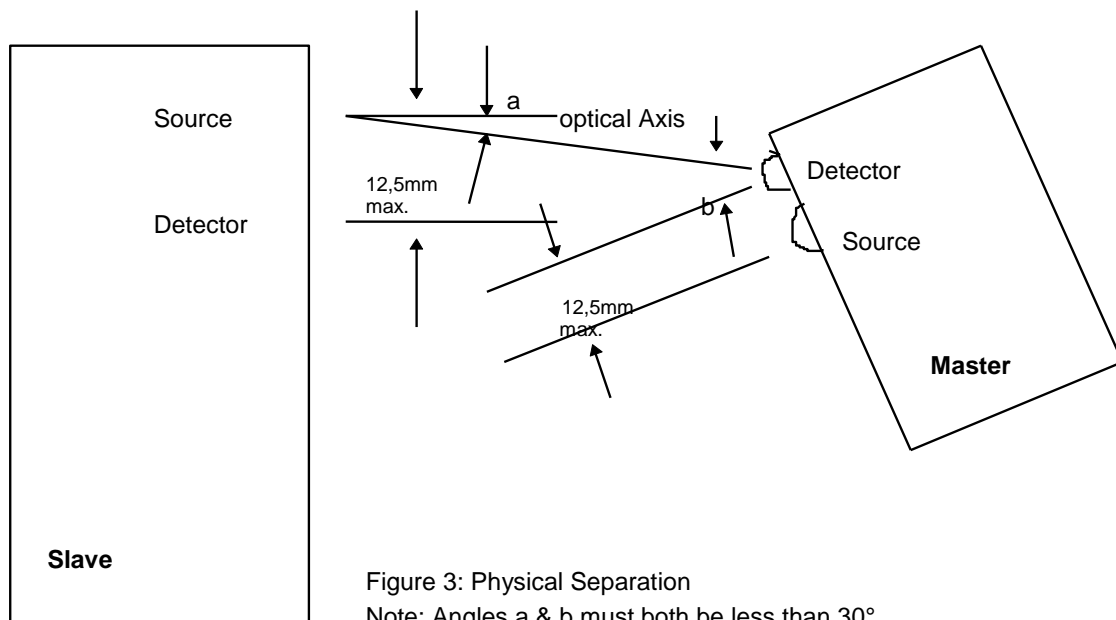

Note: Operation of the link at distances of <50mm and >200mm is permitted (to maintain compatibility with old V4 standard).



APPENDIX A - DATA DICTIONARY

A.1 DEFINITIONS

Product Value:

The Product Value is the price stored in the PA102 for a specific product. Product Value is the amount recorded for a Paid Vend, a Free Vend, or a Test Vend.

Total Product Value Delivered = value of all Paid Vends + value of all Free Vends + value of all Test Vends

Payment Source:

Source of a value made available in payment for a Vend. Payment sources are Cash, Cashless, a Vend Token, or a Value Token.

Vend:

A vend is the delivery of a product and must be reported as only one of these types per occurrence: a Test Vend, a Free Vend, or a Paid Vend.

Complete Accountability of Paid Sales:

Payment (value) collected from all payment sources =

(Cash sales + Cash with Surcharges + Cash Overpays – Cash with Discounts – Cash credited from vending machine to coin mechanism)

- + (Cashless 1 sales + Cashless 1 with Surcharges + Cashless 1 Overpays – Cashless 1 with Discounts)
- + (Cashless 2 sales + Cashless 2 with Surcharges + Cashless 2 Overpays – Cashless 2 with Discounts)
- + (ValueToken sales + Value Token with Surcharges + ValueToken Overpays – ValueToken with Discounts)
- + (VendToken sales)

Note: May need to include Negative Sales for recycle / deposit machines.



Free Vend:

A free vend is a vend made without reference to a price list and is initiated by a special function e.g. VMC mode, PIN, or free vend card , key, coin (not a Free Vend Token) that controls a "Free Vend Mode". A vend at a price of zero is only considered to be a free vend if it was initiated by a special function. Discounts, Surcharges and Overpay cannot apply to a Free Vend. The vend of a product with a price of 0 or a Vend Token is a paid vend.

Test Vend:

A test vend is a vend initiated by a special function (e.g. switch or VMC mode) for the purpose of testing the function of the vending machine. Cash, tokens, cashless credit, discounts, surcharges, etc., may be used in the performance of a Test Vend. however the sales and vend fields associated with these payment methods apply to a Paid Vend only and are not altered. Likewise, no Free Vend fields are altered due to a Test Vend.

Paid Vend:

A paid vend is a vend made with reference to a price, even if the set price is zero. Note that the Product Value is reported regardless of the final adjusted selling price.

Cash Vend:

A Cash Vend is a Paid Vend that requires the collection of coin or currency to complete the vend. Discounts (including 100% discounts), Surcharges, and Overpays can apply to Cash Vends. Cash Vends do not include Cashless Vend.

Cashless Vend:

A Cashless Vend is a Paid Vend which requires the interaction of a cashless device to complete the vend. Discounts (including 100% discounts), Surcharges, and Overpays can apply to Cashless Vends.

Vend Token Vend:

A Vend Token Vend is a Paid Vend that requires acceptance of a Vend Token (or Coupon) from a monetary device. It is immaterial if the Vend Token is returned at the conclusion of the Vend. The acceptance of one Vend Token is sufficient to complete one, and only one, vend. Surcharges, Overpays, and Discounts cannot apply since a Vend Token Vend is performed without reference to price. A Vend Token Vend is not reported as a Cash Vend, a Cashless Vend, nor a Value Token Vend.



Value Token Vend:

A Value Token Vend is a Paid Vend that requires acceptance of a Value Token (or Coupon). A Value Token may be used in combination with other payment sources (used as a partial payment in combination with cash or cashless value). A Value Token does not have cash value and change is not returned from the value attributed to a Value Token. It is immaterial if the Value Token is returned at the conclusion of the Vend. Discounts, Surcharges and Overpays may apply to pure Value Token Vends.

Mixed Payment Vend:

A Vend with payment contributed from more than one payment source. This is a Paid Vend with data being reported in 2 or more of the following payment categories: Cash, Cashless, and/or Value Token. The product value will be split and placed in the "Value of Sales" field for the participating payment types based on their respective contribution. The number of vends/sales data fields are incremented for each payment device which has participated in the vend. Discounts and Surcharges can be applied from/to more than one payment source during a single vend. A Vend Token Vend cannot be a Mixed Payment Vend since a Vend Token is worth one complete product vend.

Discount:

A discount is the value not collected due to special pricing. A discount can be given by the VMD and both of the cashless devices. Discounts could apply to Cash, both Cashless devices and a Value Token in the same vend. In such a case, the discount value attributed to each payment source is the value recorded for that source and only that source. A Discount may be applied to a Value Token Vend but not to a Free Vend Token Vend.

Surcharge:

A surcharge is an additional value collected due to special pricing and is a intended event. A surcharge can be given by the VMD and both of the cashless devices. Surcharges could apply to Cash, both Cashless devices and a Value Token in the same vend. In such a case, the surcharge value attributed to each payment source is the value recorded for that source and only that source. A Surcharge may be applied to a Value Token Vend but not to a Free Token Vend.

Note: A Surcharge is a planned upward price adjustment as opposed to an Overpay which is an accidental retention of more value than is necessary for the vend. An Overpay is generally caused by a low change condition in the coin mechanism.





Overpay:

Overpay is an additional value collected, and no longer available for vending, that is not specifically a surcharge. An Overpay is an unintended event as opposed to a Surcharge. It is generally due to a low change condition in the coin mechanism not allowing all the customers change to be paid back, or from a non-refundable cashless system after a failed vend. Overpays cannot apply to Vend Token Vends.





Identifier	Element Name	Contents	Type	Length Min	Length Max
AC101	Audit Module / Comms Gateway Serial Number	Configures field AM101 (not post manufacturer configurable)	AN	01	20
AC102	Audit Module / Comms Gateway Model Number	Configures field AM102 (not post manufacturer configurable)	AN	01	20
AC103	Audit Module / Comms Gateway Software Revision	Configures field AM103 (not post manufacturer configurable)	No	01	04
AC104	User Defined Field	Configures field AM104	AN	01	12
AC105	Audit Module / Comms Gateway Asset Number	Configures field AM105	AN	01	20
AM101	Audit Module / Comms Gateway Serial Number	Identification number of the Audit Module/ Comms Gateway. Typically includes a three character supplier ID code from Appendix B. This number may only be set by the Manufacturer. AM1 block is optional. If any AM1 data is transmitted, then AM101 becomes mandatory.	AN	01	20
AM102	Audit Module / Comms Gateway Model Number	Model number or description of the Audit Module / Comms Gateway.	AN	01	20
AM103	Audit Module / Comms Gateway Software Revision	Software revision number of the Audit Module / Comms Gateway.	No	01	04
AM104	User Defined Field	User Defined Data	AN	01	12
AM105	Audit Module / Comms Gateway Asset Number	Audit Module / Comms Gateway Asset Number reference for accounting purposes. Separate from serial number.	AN	01	20
BA101	Bill validator serial number	Identification number of bill validator. Typically, includes a three character supplier ID code from Appendix B (not post manufacturer configurable)	AN	01	20





Identifier	Element Name	Contents	Type	Length Min	Length Max
BA102	Bill validator model number	Model Number or description of bill validator (not post manufacturer configurable)	AN	01	20
BA103	Bill validator software rev.	Software revision of the bill validator (not post manufacturer configurable).	AN	01	04
BA104	User Defined Field	User Defined Data	AN	01	12
BA105	Bill validator asset number	Asset number used for tracking purposes. Programmable field.	AN	01	20
BC101	Control Board Serial Number	Configures field CB101 (not post manufacturer configurable)	AN	01	20
BC102	Control Board Model Number	Configures field CB102 (not post manufacturer configurable)	AN	01	20
BC103	Control Board Software Revision	Configures field CB103 (not post manufacturer configurable)	AN	01	20
BC104	User Defined Field	Configures field CB104	AN	01	12
BC105	Control Board Asset Number	Configures field CB105	AN	01	20
BC201	Bill validator serial number	Configures field BA101 (not post manufacturer configurable)	AN	01	20
BC202	Bill validator model number	Configures field BA102 (not post manufacturer configurable)	AN	01	20
BC203	Bill validator software rev.	Configures field BA103 (not post manufacturer configurable)	NO	01	04
BC204	User Defined Field	Configures field BA104	AN	01	12
BC205	Bill validator asset number	Configures field BA105	AN	01	20
CA101	Coin Mechanism Serial Number	Identification number of the coin mechanism. This number may only be set by the Manufacturer. Typically includes a three character supplier ID code from Appendix B. MDB level 2 changers may transmit a blank field but all MDB level 3 and above changers must send valid data (not post manufacturer configurable). CA1 block is optional. If any CA1 data is	AN	01	20





Identifier	Element Name	Contents	Type	Length Min	Length Max
		transmitted, then CA101 becomes mandatory.			
CA102	Coin Mechanism Model Number	Model number or description of the coin mechanism. MDB level 2 changers may transmit a blank field but all MDB level 3 and above changers must send valid data.	AN	01	20
CA103	Coin Mechanism Software Revision	Software revision number of the coin mechanism. MDB level 2 changers may transmit a blank field but all MDB level 3 and above changers must send valid data.	N0	01	04
CA104	User Defined Field	Use a Defined Data	AN	01	12
CA105	Coin Mechanism Asset Number	Asset Number reference for accounting purposes. Separate from serial number.	AN	01	20
CA201	Value of Cash Sales Since Initialisation	Value of all cash sales. Non-Resettable.	Nc	01	08
CA202	Number of Cash Vends Since Initialisation	Number of all cash vends. Non-Resettable.	N0	01	06
CA203	Value of Cash Sales Since Last Reset	Value of all cash sales. Resettable.	Nc	01	08
CA204	Number of Cash Vends Since Last Reset	Number of all cash vends. Resettable.	N0	01	06
CA301	Value of Cash In Since Last Reset	Value of all cash in. (Coins + Banknotes) Resettable.	Nc	01	08
CA302	Value of Cash To Cash Box Since Last Reset	Value of cash sent to the cashbox. (Typically today this is coins only, not banknotes, tokens are recorded separately). Resettable.	Nc	01	08
CA303	Value of Cash to Tubes Since Last Reset	Value of all coins sent to the inventory tubes, including sales and manually filled. Does not include value of free vend tokens.	Nc	01	08





Identifier	Element Name	Contents	Type	Length Min	Length Max
		Resettable.			
CA304	Value of Bills In Since Last Reset	<p>Total value of all bills (banknotes) accepted. Does not include value of free vend tokens.</p> <p><u>This format is used in a wide installed base and must be maintained in existing and new designs for 5 years from the introduction of Version 6.0 (until 2009). After this date, new designs need only send CA309. Check with equipment suppliers to verify their formatting.</u></p> <p><u>Implemented formats include:</u></p> <p><u>1) In most North American implementations, the value of the note is divided by 100, and is sent as an N0 data type.</u></p> <p>Example: A \$5.00 bill is sent as 5. A \$20.00 bill is sent as 20.</p> <p><u>2) In most European implementations, the value of the note is not divided by 100, and is sent as an Nc data type.</u></p> <p>Example: A €5.00 bill is sent as 500. A €20.00 bill is sent as 2000.</p> <p>Resettable.</p>	N0 / Nc	01	08
CA305	Value of Cash In Since Initialisation	<p>Value of cash in from all sources (coins and paper currency).</p> <p>Non-Resettable.</p>	Nc	01	08
CA306	Value of Cash To Cash Box Since Initialisation	<p>Value of cash sent to the cashbox. (Typically today this is coins only, no banknotes). Does not include value of free vend tokens. Non-Resettable.</p>	Nc	01	08
CA307	Value of Cash To Tubes Since Initialisation	<p>Value of all coins sent to the inventory tubes, including sales and manually filled. Does not include value of free vend tokens.</p> <p>Non-Resettable.</p>	Nc	01	08





Identifier	Element Name	Contents	Type	Length Min	Length Max
CA308	Value of Bills In Since Initialisation	<p>Total value of all bills (banknotes) accepted. Does not include value of free vend tokens.</p> <p><u>This format is used in a wide installed base and must be maintained in existing and new designs for 5 years from the introduction of Version 6.0 (until 2009). After this date, new designs need only send CA310.</u></p> <p><u>Check with equipment suppliers to verify their formatting.</u></p> <p><u>Implemented formats include:</u></p> <p><u>1) In most North American implementations, the value of the note is divided by 100, and is sent as an N0 data type.</u> Example: A \$5.00 bill is sent as 5. A \$20.00 bill is sent as 20.</p> <p><u>2) In most European implementations, the value of the note is not divided by 100, and is sent as an Nc data type.</u> Example: A €5.00 bill is sent as 500. A €20.00 bill is sent as 2000.</p> <p>Non-Resettable.</p>	N0 / Nc	01	08
CA309	Value of Bills In Since Last Reset	<p>Total value of all bills (banknotes) accepted. Does not include value of free vend tokens.</p> <p>Example: A \$5.00 bill is sent as 500. A \$20.00 bill is sent as 2000.</p> <p>Resettable.</p>	Nc	01	08
CA310	Value of Bills In Since Initialisation	<p>Total value of all bills (banknotes) accepted. Does not include value of free vend tokens.</p> <p>Example: A \$5.00 bill is sent as 500. A \$20.00 bill is sent as 2000.</p> <p>Non-Resettable.</p>	Nc	01	08





Identifier	Element Name	Contents	Type	Length Min	Length Max
CA311	Value of Bills To Recycler Since Last Reset	Value of all bills sent to the recycler, including sales and manual fill modes. Does not include value of free vend coupons. Example: A \$5.00 bill is sent as 500. A \$20.00 bill is sent as 2000. Resettable.	Nc	01	08
CA312	Value of Bills To Recycler Since Initialisation	Value of all bills sent to the recycler, including sales and manual fill modes. Does not include value of free vend coupons. Example: A \$5.00 bill is sent as 500. A \$20.00 bill is sent as 2000. Non-Resettable.	Nc	01	08
CA401	Value of Cash Dispensed Since Last Reset	Total value paid out as change plus the value manually dispensed. (Typically coins only). Resettable.	Nc	01	08
CA402	Value of Cash Manually Dispensed Since Last Reset	Total value dispensed manually. (Typically coins only) Resettable.	Nc	01	08
CA403	Value of Cash Dispensed Since Initialisation	Total value paid out as change plus the value manually dispensed. (Typically coins only). Non-Resettable.	Nc	01	08
CA404	Value of Cash Manually Dispensed Since Initialisation	Total value dispensed manually. (Typically coins only) Non-Resettable.	Nc	01	08
CA405	Value of Bills Dispensed Since Last Reset	Total value paid out as change plus the value manually dispensed. (Typically Bills only, not coupons or tokens). Resettable.	Nc	01	08
CA406	Value of Bills Manually Dispensed Since Last Reset	Total value dispensed manually. (Typically bills only, not coupons or tokens) Resettable.	Nc	01	08





Identifier	Element Name	Contents	Type	Length Min	Length Max
CA407	Value of Bills Dispensed To Recycler Since Last Reset	Total value manually dispensed from the recycler to the cashbox. (Typically bills only, not coupons or tokens). Resettable.	Nc	01	08
CA408	Value of Bills Dispensed Since Initialisation	Total value paid out as change plus the value manually dispensed. (Typically bills only, not coupons or tokens). Non-Resettable.	Nc	01	08
CA409	Value of Bills Manually Dispensed Since Initialisation	Total value dispensed manually. (Typically bills only, not coupons or tokens) Non-Resettable.	Nc	01	08
CA410	Value of Bills Manually Dispensed To Recycler Since Initialisation	Total value manually dispensed from the recycler to the cashbox. (Typically bills only, not coupons or tokens) Non-Resettable.	Nc	01	08
CA501	Number of Power Outages Since Last Reset	Total number of power down - up cycles. Resettable. Superseded by event audit see reference EA701	N0	01	08
CA502	Number of Power Outages Since Initialisation	Total number of power down - up cycles. Non-Resettable. Superseded by event audit see reference EA702	N0	01	08
CA601	Number Of Reads Performed Since Initialisation	Total number of data collection reads performed. Non-Resettable. Superseded by event audit see reference EA301	N0	01	08
CA602	Number of Door Openings Since initialisation	The number of times the vending machine door has been opened. Non Resettable Superseded by event audit see reference EA201/202	N0	01	08
CA701	Value of Cash Discounts Since Last Reset	Value of cash discounts given. (vend price - price paid = discount value). Resettable.	Nc	01	08
CA702	Value of Cash	Value of cash discounts given.	Nc	01	08





Identifier	Element Name	Contents	Type	Length Min	Length Max
	Discounts Since Initialisation	(vend price - price paid = discount value). Non-Resettable.			
CA703	Number of Cash Discounts Since Last Reset	Number of cash discounts given. Resettable.	N0	01	08
CA704	Number of Cash Discounts Since Initialisation	Number of cash discounts given. Non-Resettable.	N0	01	08
CA705	Value of Cash Surcharges Since Last Reset	Value of cash surcharges given. (price paid - vend paid = surcharge value). Resettable.	Nc	01	08
CA706	Value of Cash Surcharges Since Initialization	Value of cash surcharges given. (price paid - vend paid = surcharge value). Non-Resettable.	Nc	01	08
CA707	Number of Cash Surcharges Since Last Reset	Number of cash surcharges given. Resettable.	N0	01	08
CA708	Number of Cash Surcharges Since Initialisation	Number of cash surcharges given. Non-Resettable.	N0	01	08
CA801	Value of Cash Overpay Since Last Reset	Value of cash overpay received. (Inserted money - change paid - vend price = overpay value). Resettable.	Nc	01	08
CA802	Value of Cash Overpay Since Initialisation	Value of cash overpay received. (Inserted money - change paid - vend price = overpay value). Non-Resettable.	Nc	01	08
CA901	Value of Pay Vends Exact Change Since Last Reset	Value of the vends performed while in an exact change condition. Resettable.	Nc	01	08
CA902	Value of Pay Vends Exact Change Since Initialisation	Value of the vends performed while in an exact change condition. Non-Resettable.	Nc	01	08





Identifier	Element Name	Contents	Type	Length Min	Length Max
CA1001	Value of Cash Filled Since Last Reset	Value of all coins manually added to the machine. (filled inventory tubes) Resettable.	Nc	01	08
CA1002	Value of Cash Filled Since Initialisation	Value of all coins manually added to the machine. (filled inventory tubes) Non-Resettable.	Nc	01	08
CA1003	Value of Bills Filled Since Last Reset	Value of all bills manually added to the machine. (filled recycler) Resettable.	Nc	01	08
CA1004	Value of Cash Filled Since Initialisation	Value of all bills manually added to the machine. (filled recycler) Non-Resettable.	Nc	01	08
CA1101	Value of Accepted Coin	Value of the coin being reported on.	Nc	01	08
CA1102	Number of Coins In Since Last Reset	Number of coins of this value (CA1101) accepted. Resettable.	N0	01	08
CA1103	Number of Coins To Cash Box Since Last Reset	Number of coins of this value (CA1101) accepted and sent to the cashbox. Resettable.	N0	01	08
CA1104	Number of Coins To Tubes Since Last Reset	Number of coins of this value (CA1101) accepted and sent to the inventory tubes Resettable.	N0	01	08
CA1105	Number of Coins In Since Initialisation	Number of coins of this value (CA1101) accepted. Non-Resettable.	N0	01	08
CA1106	Number of Coins To Cash Box Since Initialisation	Number of coins of this value (CA1101) accepted and sent to the cashbox. Non-Resettable.	N0	01	08
CA1107	Number of Coins To Tubes Since Initialisation	Number of coins of this value (CA1101) accepted and sent to the inventory tubes Non-Resettable.	N0	01	08
CA1108	Age of Coin	Number to indicate age of the coin. Lowest	N0	01	01





Identifier	Element Name	Contents	Type	Length Min	Length Max
		number is oldest, base 0, So if two coins of the same denomination are accepted e.g. UK 5p, then old = 0, 5p new = 1 and so on.			
CA1109	Country of Origin	International telephone code for coins of this value (CA1101) for non standard country of origin. Default country is identified by element ID402.	N0	01	03
CA1201	Dispensed Value Coin	Value of the dispensed coin being reported on.	Nc	01	08
CA1202	Number of Coins Dispensed Since Last Reset	Number of coins of this value (CA1201) paid out as change plus manually dispensed. Resettable.	N0	01	08
CA1203	Number of Coins Manually Dispensed Since Last Reset	Number of coins of this value (CA1201) manually dispensed. Resettable.	N0	01	08
CA1204	Number of Coins Dispensed Since Initialisation	Number of coins of this value (CA1201) paid out as change plus manually dispensed. Non-Resettable.	N0	01	08
CA1205	Number of Coins Manually Dispensed Since Initialisation	Number of coins of this value (CA1201) manually dispensed. Non-Resettable.	N0	01	08
CA1206	Age of Coin	Number to indicate age of the coin. Lowest number is oldest, base 0. So if two coins of the same denomination are dispensed e.g. UK 5p, then old = 0, 5p new = 1 and so on.	N0	01	01
CA1207	Country of Origin	International telephone code for coins of this value (CA1201) for non standard country of origin. Default country is identified by element ID402.	N0	01	03
CA1301	Manually Filled Coin Value	Value of the coin manually filled being reported on.	Nc	01	08
CA1302	Number of Coins Filled Since Last Reset	Number of coins of this value (CA1301) manually filled. Resettable.	N0	01	08





Identifier	Element Name	Contents	Type	Length Min	Length Max
CA1303	Number of Coins Filled Since Initialisation	Number of coins of this value (CA1301) manually filled. Non-Resettable.	N0	01	08
CA1304	Age of Coin	Number to indicate age of the coin. Lowest number is oldest, base 0. So if two coins of the same denomination are filled e.g. UK 5p, then old = 0, 5p new = 1 and so on.	N0	01	01
CA1305	Country of Origin	International telephone code for non standard country of origin. Default country is identified by element ID402.	N0	01	03
CA1401	Bill Value	Value of bill being reported on.	Nc	01	08
CA1402	Number of Bills In Since Last Reset	Number of bills of this value (CA1401) validated but returned by the VMD as well as those that are routed to the stacker. Resettable.	N0	01	08
CA1403	Number of Bills To Stacker Since Last Reset	Number of bills of this value (CA1401) validated and routed to the stacker Resettable.	N0	01	08
CA1404	Number of Bills In Since Initialisation	Number of bills of this value (CA1401) validated but returned by the VMC as well as those that are routed to the stacker. Non-Resettable.	N0	01	08
CA1405	Number of Bills To Stacker Since Initialisation	Number of bills of this value (CA1401) validated and routed to the stacker Non-Resettable.	N0	01	08
CA1501	Value of Tube Contents	Value of coins stored in all tubes of the coin changer.	Nc	01	08
CA1502	Block No Tube 1 = Coin Type 0-7, Tube 2 = Coin Type 8-15	Tube 1 indicates CA1503-CA1510 Refers to Coin Type 0-7 Tube 2 indicates CA1503-CA1510 Refers to Coin Type 8-15	AN	01	05
CA1503	Coin Type 0 or 7 count	Number of coins in tube 0 or 7	N0	01	03





Identifier	Element Name	Contents	Type	Length Min	Length Max
CA1504	Coin Type 1 or 8 count	Number of coins in tube 1 or 8	N0	01	03
CA1505	Coin Type 2 or 9 count	Number of coins in tube 2 or 9	N0	01	03
CA1506	Coin Type 3 or 10 count	Number of coins in tube 3 or 10	N0	01	03
CA1507	Coin Type 4 or 11 count	Number of coins in tube 4 or 11	N0	01	03
CA1508	Coin Type 5 or 12 count	Number of coins in tube 5 or 12	N0	01	03
CA1509	Coin Type 6 or 13 count	Number of coins in tube 6 or 13	N0	01	03
CA1510	Coin Type 7 or 14 count	Number of coins in tube 7 or 14	N0	01	03
CA1601	Value Credited From Machine Since Last Reset	Value credited from vending machine to coin mechanism. This is the "Negative Vend" from specification BDV001. Resettable.	Nc	01	08
CA1602	Value Credited From Machine Since Initialisation	Value credited from vending machine to coin mechanism. This is the "Negative Vend" from specification BDV001. Non Resettable.	Nc	01	08
CA1701	Coin Type Number (per MDB coin tube)	The coin type number as referred to in the MDB interface specification. If not an MDB system, the number represents the coin's position in the coin set starting with the lowest value coin accepted. Note, if two or more vintage of the same coin is accepted, the oldest one is first.	N0	01	03
CA1702	Value of Coin	The cash value of the coin (units base, not scaled units). Examples for Canadian coins: Nickel 5 \$1 Dollar 100 Dime 10 \$2 Dollar 200	Nc	01	08





Identifier	Element Name	Contents	Type	Length Min	Length Max
		Quarter 25			
CA1703	Number of Coins in Tube	The interim number of coins in the coin tube (or tubes if multiple tubes per coin) that are not typically reported by the coin mech during normal vending operations. Note that this is the "best known tube count" and may be inaccurate if coins were manually added or removed by hand.	N0	01	08
CA1704	Number of Coins inserted during Controlled Manual Fill	The interim number of coins inserted while the changer was in a controlled- manual fill mode. Controlled-manual fill indicates that the coins are being inserted under the control of the coin mech or VMC. Coins are not being loaded by hand through the tops of the tubes.	N0	01	08
CA1705	Number of Coins Dispensed during Controlled Manual Invent	The interim number of coins dispensed while the changer was in a controlled-manual invent mode. Controlled-manual invent indicates that the coins are being dispensed under the control of the coin mech or VMC. Coins are not being removed by hand by "dumping" the tubes.	N0	01	08
CA1706	Coin Tube Is Full	Defined values: 0 or empty (recommended) = Tube(s) NOT full 1 = Tube is currently full	N0	01	01
CA1801	Destination of Coin	Defined values: 0=Coin sent to tubes 1=Coin sent to cash	N0	01	01
CA1802	Value of accepted coin	as per CA1702	Nc	01	08
CA1901	Value of Accepted Bill	Value of the bill being reported on.	Nc	01	08
CA1902	Number of Bills In Since Last Reset	Number of bills of this value (CA1901) accepted. Resettable.	N0	01	08
CA1903	Number of Bills To Cash Box Since Last Reset	Number of bills of this value (CA1901) accepted and sent to the cashbox. Resettable.	N0	01	08





Identifier	Element Name	Contents	Type	Length Min	Length Max
CA1904	Number of Bills To Recycler Since Last Reset	Number of bills of this value (CA1901) accepted and sent to the recycler Resettable.	N0	01	08
CA1905	Number of Bills In Since Initialisation	Number of bills of this value (CA1901) accepted. Non-Resettable.	N0	01	08
CA1906	Number of Bills To Cash Box Since Initialisation	Number of bills of this value (CA1901) accepted and sent to the cashbox. Non-Resettable.	N0	01	08
CA1907	Number of Bills To Recycler Since Initialisation	Number of bills of this value (CA1901) accepted and sent to the recycler Non-Resettable.	N0	01	08
CA1908	Age of Bill	Number to indicate age of the bill. Lowest number is oldest, base 0, So if two bills of the same denomination are accepted e.g. UK 1£, then old = 0, 1£ new = 1 and so on.	N0	01	01
CA1909	Country of Origin	International telephone code for bills of this value (CA1901) for non standard country of origin. Default country is identified by element ID402.	N0	01	03
CA2001	Dispensed Value Bill	Value of the dispensed bill being reported on.	Nc	01	08
CA2002	Number of Bills Dispensed Since Last Reset	Number of bills of this value (CA2001) paid out as change plus manually dispensed. Resettable.	N0	01	08
CA2003	Number of Bills Manually Dispensed Since Last Reset	Number of bills of this value (CA2001) manually dispensed. Resettable.	N0	01	08
CA2004	Number of Bills Manually Dispensed To Cashbox Since Last Reset	Number of bills of this value (CA2001) manually dispensed from the recycler to the cashbox. Resettable.	N0	01	08
CA2005	Number of Bills Dispensed Since	Number of bills of this value (CA2001) paid out as change plus manually dispensed.	N0	01	08





Identifier	Element Name	Contents	Type	Length Min	Length Max
	Initialisation	Non-Resettable.			
CA2006	Number of Bills Manually Dispensed Since Initialisation	Number of bills of this value (CA2001) manually dispensed. Non-Resettable.	N0	01	08
CA2007	Number of Bills Manually Dispensed To Cashbox Since Initialisation	Number of bills of this value (CA2001) manually dispensed from the recycler to the cashbox. Non-Resettable.	N0	01	08
CA2008	Age of Bill	Number to indicate age of the bill. Lowest number is oldest, base 0. So if two bills of the same denomination are dispensed e.g. UK 1£, then old = 0, 1£ new = 1 and so on.	N0	01	01
CA2009	Country of Origin	International telephone code for bills of this value (CA2001) for non standard country of origin. Default country is identified by element ID402.	N0	01	03
CA2101	Manually Filled Bill Value	Value of the bill manually filled being reported on.	Nc	01	08
CA2102	Number of Bills Filled Since Last Reset	Number of bills of this value (CA2101) manually filled. Resettable.	N0	01	08
CA2103	Number of Bills Filled Since Initialisation	Number of bills of this value (CA2101) manually filled. Non-Resettable.	N0	01	08
CA2104	Age of Bill	Number to indicate age of the bill. Lowest number is oldest, base 0. So if two bills of the same denomination are filled e.g. UK 1£, then old = 0, 1£ new = 1 and so on.	N0	01	01
CA2105	Country of Origin	International telephone code for non standard country of origin. Default country is identified by element ID402.	N0	01	03
CA2201	Value of Recycler Contents	Value of all bills stored in the bill recycler.	Nc	01	08





Identifier	Element Name	Contents	Type	Length Min	Length Max
CA2202	Block No Store 1 = Bill Type 0-7, Store 2 = Bill Type 8-15	Store 1 indicates CA2203-CA2210 Refers to Bill Type 0-7 Store 2 indicates CA2203-CA2210 Refers to Bill Type 8-15	AN	01	05
CA2203	Bill Type 0 or 7 count	Number of bills in recycler 0 or 7	NO	01	03
CA2204	Bill Type 1 or 8 count	Number of bills in recycler 1 or 8	NO	01	03
CA2205	Bill Type 2 or 9 count	Number of bills in recycler 2 or 9	NO	01	03
CA2206	Bill Type 3 or 10 count	Number of bills in recycler 3 or 10	NO	01	03
CA2207	Bill Type 4 or 11 count	Number of bills in recycler 4 or 11	NO	01	03
CA2208	Bill Type 5 or 12 count	Number of bills in recycler 5 or 12	NO	01	03
CA2209	Bill Type 6 or 13 count	Number of bills in recycler 6 or 13	NO	01	03
CA2210	Bill Type 7 or 14 count	Number of bills in recycler 7 or 14	NO	01	03
CA2301	Bill Type Number (per MDB bill store)	The bill type number as referred to in the MDB interface specification. If not an MDB system, the number represents the bill's position in the bill set starting with the lowest value bill accepted. Note, if two or more vintage of the same bill is accepted, the oldest one is first.	NO	01	03
CA2302	Value of Bill	The cash value of the bill (units base, not scaled units). Examples for US bills: \$1 Dollar 100 \$2 Dollar 200 \$5 Dollar 500 ...	Nc	01	08





Identifier	Element Name	Contents	Type	Length Min	Length Max
CA2303	Number of Bills in Store	The interim number of bills in the bill store (or stores if multiple tubes per bill) that are not typically reported by the bill mech during normal vending operations. Note that this is the "best known tube count" and may be inaccurate if bills were manually added or removed by hand.	N0	01	08
CA2306	Bill Store Is Full	Defined values: 0 or empty (recommended) = Store(s) NOT full 1 = Store is currently full	N0	01	01
CA2401	Destination of Bill	Defined values: 0=Bill sent to recycler 1=Bill sent to cash	N0	01	01
CA2402	Value of accepted bill	as per CA2302	Nc	01	08
CB101	Control Board Serial Number	Identification number of the Control Board. This number may only be set by the Manufacturer. CB1 block is optional. If any CB1 data is transmitted, then CB101 becomes mandatory.	AN	01	20
CB102	Control Board Model Number	Model number or description of the Control Board.	AN	01	20
CB103	Control Board Software Revision	Software revision number of the Control Board.	AN	01	20
CB104	User Defined Field	User Defined Data	AN	01	12
CB105	Control Board Asset Number	Control Board Asset Number reference for accounting purposes. Separate from serial number.	AN	01	20
CC101	Coin Mechanism Serial Number	Configures field CA101 (not post manufacturer configurable)	AN	01	20
CC102	Coin Mechanism Model Number	Configures field CA102 (not post manufacturer configurable)	AN	01	20
CC103	Coin Mechanism Software Revision	Configures field CA103 (not post manufacturer configurable)	N0	01	04
CC104	User Defined Field	Configures field CA104	AN	01	12





Identifier	Element Name	Contents	Type	Length Min	Length Max
CC105	Coin Mechanism Asset Number	Configures field CA105	AN	01	20
DA101	Cashless 1 Serial Number	Identification number of the system (card, key or other). Typically includes a three character supplier ID code from Appendix B (not post manufacturer configurable).	AN	01	20
DA102	Cashless 1 Model Number	Model number or description of the system (card, key or other) cashless 1 unit.	AN	01	20
DA103	Cashless 1 Software Revision	Software revision number of the system (card, key or other) cashless 1 unit.	N0	01	04
DA104	User Defined Field	User Defined Data	AN	01	12
DA105	Cashless 1 Asset Number	Asset Number reference for accounting purposes. Separate from serial number.	AN	01	20
DA201	Value of Cashless 1 Sales Since Initialisation	Value of all Cashless 1 sales. Non-Resettable.	Nc	01	08
DA202	Number Of Cashless 1 Vends Since Initialisation	Number of all Cashless 1 vends. Non-Resettable.	N0	01	08
DA203	Value of Cashless 1 Sales Since Last Reset	Value of all Cashless 1 sales. Resettable.	Nc	01	08
DA204	Number of Cashless 1 Vends Since Last Reset	Number of all Cashless 1 vends. Resettable.	N0	01	06
DA205	User Defined Field	User Defined Data	AN	01	12
DA301	Value Debited From Cashless 1 Since Initialisation	Value debited from Cashless 1. Non-Resettable.	Nc	01	08
DA302	Value Debited From Cashless 1 Since Last Reset	Value debited from Cashless 1. Resettable.	Nc	01	08
DA303	User Defined Field	User Defined Data	AN	01	12
DA401	Value Credited To	Value credited to Cashless 1.	Nc	01	08





Identifier	Element Name	Contents	Type	Length Min	Length Max
	Cashless 1 Since Initialisation	Non-Resettable.			
DA402	Value Credited To Cashless 1 Since Last Reset	Value credited to Cashless 1. Resettable.	Nc	01	08
DA403	User Defined Field	User Defined Data	AN	01	12
DA501	Value of Cashless 1 Discounts Since Last Reset	Value of Cashless 1 discounts given. (vend price - price paid = discount value). Resettable.	Nc	01	08
DA502	Number Of Discount Cashless 1 Vends Since Last Reset	Number of Cashless 1 discounted vends given. Resettable.	N0	01	06
DA503	Value Of Cashless 1 Discounts Since Initialisation	Value of Cashless 1 discounts given. (vend price - price paid = discount value). Non-Resettable.	Nc	01	08
DA504	Number Of Discount Cashless 1 Vends Since Initialisation	Number of Cashless 1 discounted vends given. Non-Resettable.	N0	01	08
DA505	Value of Cashless 1 Surcharges Since Last Reset	Value of Cashless 1 surcharges given. (price paid - vend price = surcharge value). Resettable.	Nc	01	08
DA506	Number of Surcharge Cashless 1 Vends Since Last Reset	Number of Cashless 1 surcharge vends given. Resettable.	N0	01	06
DA507	Value Of Cashless 1 Surcharges Since Initialisation	Value of Cashless 1 surcharges given. (price paid - vend price = surcharge value). Non-Resettable.	Nc	01	08
DA508	Number of Surcharge Cashless 1 Vends Since Initialisation	Number of Cashless 1 surcharge vends given. Non-Resettable.	N0	01	08





Identifier	Element Name	Contents	Type	Length Min	Length Max
DA601	Revaluation Incentive on Cashless 1 Since Initialisation	The value of the additional money added to Cashless 1 as an incentive. E.g. \$10 cash input, \$11 credited to card, Incentive is \$1 Non-Resettable	Nc	01	08
DA602	Revaluation Incentive on Cashless 1 Since Last Reset	The value of the additional money added to Cashless 1 as an incentive. E.g. \$10 cash input, \$11 credited to card, Incentive is \$1 Resettable.	Nc	01	08
DA701	Cashless 1 User Group Number	Cashless 1 User group being reported on.	N0	01	13
DA702	Cashless 1 User Group Net Sales since last reset.	Net sale (equal to the value deducted from the cards) of the user group in DA701 Resettable.	Nc	01	08
DA703	User Group Value Added To Cashless 1 since last reset	Revaluation and Initialisation (equal to the value added to the cards) of the user group in DA701 Resettable.	Nc	01	08
DA704	Cashless 1 User Group Discounts since last reset	Discount deducted from the standard prices (showing up the net sale prices) of the user group in DA701. Resettable.	Nc	01	08
DA705	Number of products sold to Cashless 1 user group since initialisation	This is the number of paid vends from all payment sources of the user group in DA701 since initialisation. Non-resettable.	N0	01	08
DA706	Number of products sold to Cashless 1 user group since last reset	This is the number of paid vends from all payment sources of the user group in DA701 since last reset. Resettable.	N0	01	06
DA707	Cashless 1 User Group Net Sales since initialization	Net sale (equal to the value deducted from the cards) of the user group in DA701 Non-resettable.	Nc	01	08
DA708	User Group Value	Revaluation and Initialisation (equal to the value	Nc	01	08





Identifier	Element Name	Contents	Type	Length Min	Length Max
	Added To Cashless 1 since initialization	added to the cards) of the user group in DA701 Non-resettable.			
DA709	Cashless 1 User Group Discounts since initialization	Discount deducted from the standard prices (showing up the net sale prices) of the user group in DA701. Non-resettable.	Nc	01	08
DA801	Cashless 1 Funds Used for Sale	This field contains the amount of Cashless 1 funds used for the last sale. It is an event-driven field and is intended to be sent after every vend which uses Cashless 1 funds.	Nc	01	08
DA901	Value of Cashless Overpay Since Last Reset	Value of cashless overpay received. (Inserted cashless value – revalued amount - vend price = overpay value). Resettable.	Nc	01	08
DA902	Value of Cashless Overpay Since Initialisation	Value of cashless overpay received. (Inserted cashless value – revalued amount - vend price = overpay value). Non-Resettable.	Nc	01	08
DA1001	Cashless 1 Number of Mixed Payment Vends Since Initialization	The number of vends with cashless 1 where the sale is a mixed paid sale (cash and cashless). Non-Resettable.	N0	01	08
DA1002	Cashless 1 Value of Mixed Payment Cashless Amount Since Initialization	The value of the cashless amount paid with cashless 1 where the sale is a mixed sale (cash and cashless). Non-Resettable.	Nc	01	08
DA1003	Cashless 1 Number of Mixed Payment Vends Since Last Reset	The number of vends with cashless 1 where the sale is a mixed paid sale (cash and cashless). Resettable.	N0	01	06
DA1004	Cashless 1 Value of Mixed	The value of the cashless amount paid with cashless 1 where the sale is a mixed sale (cash and	Nc	01	08





Identifier	Element Name	Contents	Type	Length Min	Length Max
	Payment Cashless Amount Since Last Reset	cashless). Resettable.			
DB101	Cashless 2 Serial Number	Identification number of the system (card, key or other). Typically includes a three character supplier ID code from Appendix B (not post manufacturer configurable).	AN	01	20
DB102	Cashless 2 Model Number	Model number or description of the system (card, key or other) cashless 2 unit.	AN	01	20
DB103	Cashless 2 Software Revision	Software revision number of the system (card, key or other) cashless 2 unit.	N0	01	04
DB104	User Defined Field	User Defined Data	AN	01	12
DB105	Cashless 2 Asset Number	Asset Number reference for accounting purposes. Separate from serial number.	AN	01	20
DB201	Value of Cashless 2 Sales Since Initialisation	Value of all Cashless 2 sales. Non-Resettable.	Nc	01	08
DB202	Number Of Cashless 2 Vends Since Initialisation	Number of all Cashless 2 vends. Non-Resettable.	N0	01	08
DB203	Value of Cashless 2 Sales Since Last Reset	Value of all Cashless 2 sales. Resettable.	Nc	01	08
DB204	Number of Cashless 2 Vends Since Last Reset	Number of all Cashless 2 vends. Resettable.	N0	01	06
DB205	User Defined Field	User Defined Data	AN	01	12
DB301	Value Debited From Cashless 2 Since Initialisation	Value debited from Cashless 2. Non-Resettable.	Nc	01	08
DB302	Value Debited From Cashless 2 Since Last Reset	Value debited from Cashless 2. Resettable.	Nc	01	08
DB303	User Defined Field	User Defined Data	AN	01	12





Identifier	Element Name	Contents	Type	Length Min	Length Max
DB401	Value Credited To Cashless 2 Since Initialisation	Value credited to Cashless 2. Non-Resettable.	Nc	01	08
DB402	Value Credited To Cashless 2 Since Last Reset	Value credited to Cashless 2. Resettable.	Nc	01	08
DB403	User Defined Field	User Defined Data	AN	01	12
DB501	Value of Cashless 2 Discounts Since Last Reset	Value of Cashless 2 discounts given. (vend price - price paid = discount value). Resettable.	Nc	01	08
DB502	Number Of Discount Cashless 2 Vends Since Last Reset	Number of Cashless 2 discounted vends given. Resettable.	N0	01	06
DB503	Value Of Cashless 2 Discounts Since Initialisation	Value of Cashless 2 discounts given. (vend price - price paid = discount value). Non-Resettable.	Nc	01	08
DB504	Number Of Discount Cashless 2 Vends Since Initialisation	Number of Cashless 2 discounted vends given. Non-Resettable.	N0	01	08
DB505	Value of Cashless 2 Surcharges Since Last Reset	Value of Cashless 2 surcharges given. (price paid - vend price = surcharge value). Resettable.	Nc	01	08
DB506	Number of Surcharge Cashless 2 Vends Since Last Reset	Number of Cashless 2 surcharge vends given. Resettable.	N0	01	06
DB507	Value Of Cashless 2 Surcharges Since Initialisation	Value of Cashless 2 surcharges given. (price paid - vend price = surcharge value). Non-Resettable.	Nc	01	08
DB508	Number of Surcharge Cashless 2 Vends	Number of Cashless 2 surcharge vends given. Non-Resettable.	N0	01	08





Identifier	Element Name	Contents	Type	Length Min	Length Max
	Since Initialisation				
DB601	Revaluation Incentive on Cashless 2 Since Initialisation	The value of the additional money added to Cashless 2 as an incentive. E.g. \$10 cash input, \$11 credited to card, Incentive is \$1 Non-Resettable	Nc	01	08
DB602	Revaluation Incentive on Cashless 2 Since Last Reset	The value of the additional money added to Cashless 2 as an incentive. E.g. \$10 cash input, \$11 credited to card, Incentive is \$1 Resettable.	Nc	01	08
DB701	Cashless 2 User Group Number	Cashless 2 User group being reported on.	N0	01	13
DB702	Cashless 2 User Group Net Sales since last reset.	Net sale (equal to the value deducted from the cards) of the user group in DB701 Resettable.	Nc	01	08
DB703	User Group Value Added To Cashless 2 since last reset	Revaluation and Initialisation (equal to the value added to the cards) of the user group in DB701 Resettable.	Nc	01	08
DB704	Cashless 2 User Group Discounts since last reset	Discount deducted from the standard prices (showing up the net sale prices) of the user group in DB701. Resettable.	Nc	01	08
DB705	Number of products sold to Cashless 2 user group since initialisation	This is the number of paid vends from all payment sources of the user group in DB701 since initialisation. Non-resettable.	N0	01	08
DB706	Number of products sold to Cashless 2 user group since last reset	This is the number of paid vends from all payment sources of the user group in DB701 since last reset. Resettable.	N0	01	06
DB707	Cashless 2 User Group Net Sales since initialization	Net sale (equal to the value deducted from the cards) of the user group in DB701 Non-resettable.	Nc	01	08





Identifier	Element Name	Contents	Type	Length Min	Length Max
DB708	User Group Value Added To Cashless 2 since initialization	Revaluation and Initialisation (equal to the value added to the cards) of the user group in DB701 Non-resettable.	Nc	01	08
DB709	Cashless 2 User Group Discounts since initialization	Discount deducted from the standard prices (showing up the net sale prices) of the user group in DB701. Non-resettable.	Nc	01	08
DB801	Cashless 2 Funds Used for Sale	This field contains the amount of Cashless 2 funds used for the last sale. It is an event-driven field and is intended to be sent after every vend which uses Cashless 2 funds.	Nc	01	08
DB1001	Cashless 2 Number of Mixed Payment Vends Since Initialization	The number of vends with cashless 2 where the sale is a mixed paid sale (cash and cashless). Non-Resettable.	N0	01	08
DB1002	Cashless 2 Value of Mixed Payment Cashless Amount Since Initialization	The value of the cashless amount paid with cashless 2 where the sale is a mixed sale (cash and cashless). Non-Resettable.	Nc	01	08
DB1003	Cashless 2 Number of Mixed Payment Vends Since Last Reset	The number of vends with cashless 2 where the sale is a mixed paid sale (cash and cashless). Resettable.	N0	01	06
DB1004	Cashless 2 Value of Mixed Payment Cashless Amount Since Last Reset	The value of the cashless amount paid with cashless 2 where the sale is a mixed sale (cash and cashless). Resettable.	Nc	01	08
DC101	Cashless 1 Serial Number	Configures field DA101 (not post manufacturer configurable)	AN	01	20
DC102	Cashless 1 Model Number	Configures field DA102 (not post manufacturer configurable)	AN	01	20
DC103	Cashless 1	Configures field DA103 (not post manufacturer	N0	01	04





Identifier	Element Name	Contents	Type	Length Min	Length Max
	Software Revision	configurable)			
DC104	User Defined Field	Configures field DA104	AN	01	12
DC105	Cashless 1 Asset Number	Configures field DA105	AN	01	20
DD101	Cashless 2 Serial Number	Configures field DB101 (not post manufacturer configurable)	AN	01	20
DD102	Cashless 2 Model Number	Configures field DB102 (not post manufacturer configurable)	AN	01	20
DD103	Cashless 2 Software Revision	Configures field DB103 (not post manufacturer configurable)	NO	01	04
DD104	User Defined Field	Configures field DB104	AN	01	12
DD105	Cashless 2 Asset Number	Configures field DB105	AN	01	20
EA101	Event Identification	This field identifies the event being reported in data elements EA102 – EA106.	AN	01	20
EA102	Data of Event Occurance	Date the event occurred.	DT	06	08
EA103	Time of Event Occurance	Time the event occurred.	TM	04	06
EA104	Event Duration In Minutes	How long the event lasted.	NO	01	08
EA105	Event Duration In Milliseconds	Exactly how long the event lasted.	NO	01	12
EA106	User Defined Field	User Defined Data	AN	01	12
EA201	Event Identification	This field identifies the event being reported in data elements EA202 – EA204	AN	01	20
EA202	Number of Events Since Last Reset	Number of times that this event occurred. Resets after each audit data collection.	NO	01	06
EA203	Number of Events Since Initialisation	Number of times that this event occurred. Non-Resettable.	NO	01	06
EA204	User Defined Field	User Defined Data	AN	01	12
EA205	Event Activity	Indicates the current event activity.	NO	01	01





Identifier	Element Name	Contents	Type	Length Min	Length Max
		(1 = Event Active / 0 (or empty) = Event Inactive)			
EA206	Event Duration In Minutes	Duration of the event (including multiple occurrences) in minutes while the event is in State 2 (see EVENT State paragraph in Section 2).	N0	01	08
EA301	Number Of Reads with RESET Since Initialisation	The number of times that the audit unit has been interrogated with reset. This does <u>not</u> include EVENT resets. RESETs can be automatic after a read, via the SD105 RESET command, partial resets via the SD104 selective RESET command, or manual via a machine service mode. Non-Resettable. Supersedes field CA601	N0	01	08
EA302	Date Of This Read Out	Date of this interrogation.	DT	06	08
EA303	Time Of This Read Out	Time of this interrogation.	TM	04	06
EA304	This Terminal / interrogator Identification	The Terminals identification data (see ID201).	AN	01	20
EA305	Date Of Last Read Out	Date of the previous interrogation.	DT	06	08
EA306	Time Of Last Read Out	Time of the previous interrogation.	TM	04	06
EA307	Last Terminal / interrogator Identification	The identification data of the terminal that performed the previous interrogation (see ID201).	AN	01	12
EA308	User Defined Field	User Defined Data	AN	01	12
EA309	Number of Reads with or without RESET since Initialization	The number of times that the audit unit has been interrogated with or without reset. Non-Resettable.	N0	01	08
EA310	Number of Resets	The number of times that the audit unit has been	N0	01	08





Identifier	Element Name	Contents	Type	Length Min	Length Max
	since Initialization	reset. This does <u>not</u> include EVENT resets. RESETs can be automatic after a read, via the SD105 RESET command, partial resets via the SD104 selective RESET command, or manual via a machine service mode. Non-Resettable.			
EA401	Date of Initialisation	Date of initialisation Note: This may be the date of the first interrogation also.	DT	06	08
EA402	Time of Initialisation	Time of initialization Note: This may be the time of the first interrogation also.	TM	04	06
EA403	Initialisation Terminal / Interrogator Identification	The identification data of the terminal that performs the initialisation. (see ID201). Note: This may be the terminal that performs the first read out	AN	01	12
EA404	User Defined Field	User Defined Data	AN	01	12
EA501	Date of Price Setting	Date that the prices were last set.	DT	06	08
EA502	Time of Price Setting	Time that the prices were last set.	TM	04	06
EA503	Interrogator/ Terminal Identification	The identification data of the terminal that set the prices (see ID201).	AN	01	12
EA504	User Defined Field	User Defined Data	AN	01	12
EA505	Number of Price Alterations	This reports the number of changes to prices, incrementing by one for every price alteration since the last reset (e.g. up & back = +2 on the total). Resettable	N0	01	03
EA601	Date of Machine Service	Date of the last time that the machine was serviced. (cleaning, adjustment, repair)	DT	06	08
EA602	Time of Machine	Time of the last time that the machine was	TM	04	06





Identifier	Element Name	Contents	Type	Length Min	Length Max
	Service	serviced (cleaning, adjustment, repair)			
EA603	Interrogator/ Terminal Identification	The identification data of the terminal that was involved in the servicing. (see ID201).	AN	01	12
EA604	User Defined Field	User Defined Data	AN	01	12
EA701	Number of Power Outages Since Last Reset	Total number of power down - up cycles recorded by the audit unit. Supersedes CA501. Resettable.	NO	01	06
EA702	Number of Power Outages Since Initialisation	Total number of power down - up cycles recorded by the audit unit. Supersedes CA502 Non-Resettable.	NO	01	08
EA801	Repeating Event Identification	Identifies what repeating event has been set.	AN	01	20
EA802	Day of Repeating Event Occurrence	Reports the day that the event will occur. This will be of the form Day of Week, Weekday, Weekend, having values 1-7, 8, 9 respectively. Monday = 1.	AN	01	02
EA803	Hour Of Repeating Event Occurrence	Reports the hour that the event will occur, in hours timed from midnight. (24 Hour Clock)	NO	01	02
EA804	Minute of Repeating Event Occurrence	Reports the start time in minutes from midnight that the event will occur.	NO	01	04
EA805	Millisecond Of Repeating Event Occurrence	Reports the start time in milliseconds from midnight that the event will occur.	NO	01	12
EA806	User Defined Field	User Defined Data	AN	01	12
EA901	Machine Hours Since Initialisation	Number of machine hours since initialization.	NO	01	06
EA902	Total Number of Products Dispensed Since Initialisation	Total number of products dispensed since initialization.	NO	01	08
EA903	User Defined Field	User Defined Data	AN	01	12
EC806	User Defined Field	Configures field EA806	AN	01	12





Identifier	Element Name	Contents	Type	Length Min	Length Max
HA101	Hopper/Dispenser Serial Number	Identification number of the hopper/dispenser mechanism. This number may only be set by the Manufacturer. Typically includes a three character supplier ID code from Appendix B. Programmed at factory, not user changeable. HA1 block is optional. If any HA1 data is transmitted, then HA101 becomes mandatory.	AN	01	20
HA102	Hopper/Dispenser Model	Number/Model number or description of the hopper/dispenser	AN	01	20
HA103	Hopper/Dispenser Software Revision	Software revision number of the hopper/dispenser	NO	01	04
HA104	User Defined Field	User defined data	AN	01	12
HA105	Hopper/Dispenser Asset Number	Asset number reference for accounting purposes. Separate from serial number	AN	01	20
HA201	Value of Cash In Since Last Reset	Value of Cash filled in. Includes cash filled in by a mechanism during sales (e. g. coin validator) and cash filled in manually. Resettable	Nc	01	08
HA202	Value of Cash Filled Since Last Reset	Value of Cash manually added to the hopper/dispenser (manually filled and fill mode) Resettable	Nc	01	08
HA203	Value of Cash In Since Initialisation	Value of Cash filled in. Includes cash filled in by a mechanism during sales (e. g. coin validator) and cash filled in manually. Non-Resettable	Nc	01	08
HA204	Value of Cash Filled Since Initialisation	Value of Cash manually added to the hopper/dispenser (manually filled and fill mode) Non-Resettable	Nc	01	08
HA301	Value of Cash Dispensed Since Last Reset	Value paid out as change plus the value manually dispensed Resettable	Nc	01	08
HA302	Value of Cash Manually Dispensed Since Last Reset	Value dispensed manually Resettable	Nc	01	08





Identifier	Element Name	Contents	Type	Length Min	Length Max
HA303	Value of Cash Dispensed Since Initialisation	Value paid out as change plus the value manually dispensed Non-Resattable	Nc	01	08
HA304	Value of Cash Manually Dispensed Since Initialisation	Value dispensed manually Non-Resattable	Nc	01	08
HA401	Value of Hopper/Dispenser Contents	Value of cash stored in all hopper/dispenser containers of the hopper/dispenser	Nc	01	08
HA402	Block No. 1 = Coin/Bill Type 0 – 7 Block No. 2 = Coin/Bill Type 8 – 15	A "1" indicates HA403 to HA410 refers to coin/bill Type 0 – 7 A "2" indicates HA403 to HA410 refers to coin/bill Type 8 – 15	N0	01	01
HA403	Coin/Bill Type 0 or 8	Number of coins/bills in container coin/bill type 0 or 8	N0	01	03
HA404	Coin/Bill Type 1 or 9	Number of coins/bills in container coin/bill type 1 or 9	N0	01	03
HA405	Coin/Bill Type 2 or 10	Number of coins/bills in container coin/bill type 2 or 10	N0	01	03
HA406	Coin/Bill Type 3 or 11	Number of coins/bills in container coin/bill type 3 or 11	N0	01	03
HA407	Coin/Bill Type 4 or 12	Number of coins/bills in container coin/bill type 4 or 12	N0	01	03
HA408	Coin/Bill Type 5 or 13	Number of coins/bills in container coin/bill type 5 or 13	N0	01	03
HA409	Coin/Bill Type 6 or 14	Number of coins/bills in container coin/bill type 6 or 14	N0	01	03
HA410	Coin/Bill Type 7 or 15	Number of coins/bills in container coin/bill type 7 or 15	N0	01	03
HB101	Hopper/Dispenser Serial Number	Identification number of the hopper/dispenser mechanism. This number may only be set by the Manufacturer. Typically includes a three character	AN	01	20





Identifier	Element Name	Contents	Type	Length Min	Length Max
		supplier ID code from Appendix B. Programmed at factory, not user changeable. HB1 block is optional. If any HB1 data is transmitted, then HB101 becomes mandatory.			
HB102	Hopper/Dispenser Model	NumberModel number or description of the hopper/dispenser	AN	01	20
HB103	Hopper/Dispenser Software Revision	Software revision number of the hopper/dispenser	N0	01	04
HB104	User Defined Field	User defined data	AN	01	12
HB105	Hopper/Dispenser Asset Number	Asset number reference for accounting purposes. Separate from serial number	AN	01	20
HB201	Value of Cash In Since Last Reset	Value of cash filled in. Includes cash filled in by a mechanism during sales (e. g. coin validator) and cash filled in manually. Resettable	Nc	01	08
HB202	Value of Cash Filled Since Last Reset	Value of cash manually added to the hopper/dispenser (manually filled and fill mode) Resettable	Nc	01	08
HB203	Value of Cash In Since Initialisation	Value of cash filled in. Includes cash filled in by a mechanism during sales (e. g. coin validator) and cash filled in manually. Non-Resettable	Nc	01	08
HB204	Value of Cash Filled Since Initialisation	Value of cash manually added to the hopper/dispenser (manually filled and fill mode) Non-Resettable	Nc	01	08
HB301	Value of Cash Dispensed Since Last Reset	Value paid out as change plus the value manually dispensed Resettable	Nc	01	08
HB302	Value of Cash Manually Dispensed Since Last Reset	Value dispensed manually Resettable	Nc	01	08
HB303	Value of Cash Dispensed Since Initialisation	Value paid out as change plus the value manually dispensed Non-Resettable	Nc	01	08





Identifier	Element Name	Contents	Type	Length Min	Length Max
HB304	Value of Cash Manually Dispensed Since Initialisation	Value dispensed manually Non-Resattable	Nc	01	08
HB401	Value of Hopper/Dispenser Contents	Value of cash stored in all hopper/dispenser containers of the hopper/dispenser	Nc	01	08
HB402	Block No. 1 = Coin/bill Type 0 – 7 Block No. 2 = Coin/bill Type 8 – 15	A "1" indicates HB403 to HB410 refers to Coin/bill Type 0 – 7 A "2" indicates HB403 to HB410 refers to Coin/bill Type 8 - 15	N0	01	01
HB403	Coin/Bill Type 0 or 8	Number of coins/bills in container coin/bill type 0 or 8	N0	01	03
HB404	Coin/Bill Type 1 or 9	Number of coins/bills in container coin/bill type 1 or 9	N0	01	03
HB405	Coin/Bill Type 2 or 10	Number of coins/bills in container coin/bill type 2 or 10	N0	01	03
HB406	Coin/Bill Type 3 or 11	Number of coins/bills in container coin/bill type 3 or 11	N0	01	03
HB407	Coin/Bill Type 4 or 12	Number of coins/bills in container coin/bill type 4 or 12	N0	01	03
HB408	Coin/Bill Type 5 or 13	Number of coins/bills in container coin/bill type 5 or 13	N0	01	03
HB409	Coin/Bill Type 6 or 14	Number of coins/bills in container coin/bill type 6 or 14	N0	01	03
HB410	Coin/Bill Type 7 or 15	Number of coins/bills in container coin/bill type 7 or 15	N0	01	03
HC101	Hopper/Dispenser Serial Number	Configures field HA101 (NOT FIELD CONFIGURABLE)	AN	01	20
HC102	Hopper/Dispenser Model Number	Configures field HA102 (NOT FIELD CONFIGURABLE)	AN	01	20
HC103	Hopper/Dispenser	Configures field HA103 (NOT FIELD CONFIGURABLE)	N0	01	04





Identifier	Element Name	Contents	Type	Length Min	Length Max
	Software Revision	CONFIGURABLE)			
HC104	User Defined Field	Configures field HA104	AN	01	12
HC105	Hopper/Dispenser Asset Number	Configures field HA105	AN	01	20
HD101	Hopper/Dispenser Serial Number	Configures field HB101 (NOT FIELD CONFIGURABLE)	AN	01	20
HD102	Hopper/Dispenser Model Number	Configures field HB102 (NOT FIELD CONFIGURABLE)	AN	01	20
HD103	Hopper/Dispenser Software Revision	Configures field HB103 (NOT FIELD CONFIGURABLE)	NO	01	04
HD104	User Defined Field	Configures field HB104	AN	01	12
HD105	Hopper/Dispenser Asset Number	Configures field HB105	AN	01	20
IC101	Machine Serial Number	Configures field ID101 (not post manufacturer configurable)	AN	01	20
IC102	Machine Model	Configures field ID102 (not post manufacturer	AN	01	20





Identifier	Element Name	Contents	Type	Length Min	Length Max
	Number	configurable)			
IC103	Machine Build Standard	Configures field ID103 (not post manufacturer configurable)	NO	01	04
IC104	Machine Location	Configures field ID104	AN	01	30
IC105	User Defined Field	Configures field ID105	AN	01	12
IC106	Machine Asset Number	Configures field ID106	AN	01	20
IC201	Data Carrier Serial Number	Configures field ID201 (not post manufacturer configurable)	AN	01	20
IC202	Data Carrier Model Number	Configures field ID202 (not post manufacturer configurable)	AN	01	20
IC203	Data Carrier Software Revision	Configures field ID203 (not post manufacturer configurable)	NO	01	04
IC204	User Defined Field	Configures field ID204	AN	01	12
IC205	Data Carrier Asset Number	Configures field ID205	AN	01	20
IC301	Route Number	Configures field ID301	AN	01	12
IC302	User Function	Configures field ID302	AN	01	20
IC303	Route Person Name	Configures field ID303	AN	01	20
IC304	User Defined Field	Configures field ID304	AN	01	12
IC401	Decimal Point Position	Configures field ID401	NO	01	01
IC402	Country Code	Configures field ID402	NO	01	03
IC403	Currency Description	Configures field ID403	AN	01	08
IC501	System Date	Configures field ID501	DT	06	08
IC502	System Time	Configures field ID502	TM	04	06
IC503	System Time In Seconds	Configures field ID503	NO	01	02
IC504	System Daylight Savings Mode	Configures the current status of daylight savings mode.	AN	02	03





Identifier	Element Name	Contents	Type	Length Min	Length Max
		OFF = Off (no daylight savings mode) NA = North American rules EU = European rules AUS = Australian rules			
IC601	Current Cash Bag Number	Configures ID601	AN	01	20
IC701	Payment system index	Configures field ID701	AN	01	6
IC702	Payment system Category	Configures field ID702	AN	01	4
IC703	Manufacturer code	Configures field ID703	AN	01	20
IC704	Serial No.	Configures field ID704 (not post manufacturer configurable)	AN	01	20
IC705	Model	Configures field ID705 (not post manufacturer configurable)	AN	01	20
IC706	Software revision	Configures field ID706 (not post manufacturer configurable)	AN	01	20
IC707	Status	Configures field ID707	N0	01	10
IC708	User Defined Field	Configures field ID708	AN	01	12
ID101	Machine Serial Number	Machine identification number. Possibly the ID of the VMD. It should include a three character supplier ID code from Appendix B.	AN	01	20
ID102	Machine Model Number	Machine model number or description.	AN	01	20
ID103	Machine Build Standard	This element describes the build standard of the machine. It may be the Audit Unit or Vending Machine Controller software revision number.	N0	01	04
ID104	Machine Location	Description of the machine location. May be e.g. "1st floor by the lift".	AN	01	30
ID105	User Defined Field	The meaning of this field is dependent on the	AN	01	12





Identifier	Element Name	Contents	Type	Length Min	Length Max
		specific device or category it is associated with. Typically the block type and machine identification will indicate the specific data.			
ID106	Machine Asset Number	Unique number which operator can enter for accounting purposes (see Chapter 5)	AN	01	20
ID107	DTS Level	Specifies level number of the DTS Standard e.g. level 6 for DTS version 6.0.	N0	01	02
ID108	DTS Revision	Specifies any revision to the main DTS level e.g. revision 1 for potential DTS version 6.1.	N0	01	04
ID201	Data Carrier Serial Number	Terminal or data carrier identification number. This is a User defined number.	AN	01	20
ID202	Data Carrier Model Number	Terminal or data carrier model number or description.	AN	01	20
ID203	Data Carrier Software Revision	Terminal or data carrier software revision number.	N0	01	04
ID204	User Defined Field	User Defined Data	AN	01	12
ID205	Data Carrier Asset Number	Data Carrier Asset Number reference for accounting purposes. This is separate from serial number.	AN	01	20
ID301	Route Number	Route number or description.	AN	01	12
ID302	User Function	Route function being performed. (Audit, Service, Supervisor, etc.)	AN	01	20
ID303	Route Person Name	Name of the route person under ID302.	AN	01	20
ID304	User Defined Field	User Defined Data	AN	01	12
ID401	Decimal Point Position	This field is used in countries whose currency requires a number of digits to the right of the decimal point other than 2. This information is typically reported to the VMC by the peripheral(s).	N0	01	01
ID402	Numeric Currency Code	Currency identification by International Telephone Country Code or ISO 4217 numeric currency code. All new designs after July, 2000 must use the ISO 4217 numeric currency codes.	N0	04	04





Identifier	Element Name	Contents	Type	Length Min	Length Max
		<p>If the left most digit is a 0, the International Telephone Code is used to indicate the currency. For example, the USA code is 0001.</p> <p>If the left most digit is a 1, the latest version of the ISO 4217 numeric currency code is used. For example, the code for the US dollar is 1840 and the Euro is 1978.</p>			
ID403	Alphabetic Currency Code	This alpha-numeric field is used to define or describe the currency in use. Typically it is the ISO 4217 alphabetic currency code.	AN	03	03
ID501	System Date	Reports the machine Date.	DT	06	08
ID502	System Time	Reports the machine Time.	TM	04	06
ID503	System Time - Seconds	Reports the machine Time Seconds if ID502 is reported in the Hour Minute (HHMM) order. Used to report seconds to the interrogating device. Note that the interrogating device may use IC503 to update the time and thus keep the system synchronised.	N0	01	02
ID504	System Daylight Savings Mode	Reports the current status of daylight savings mode. OFF = Off (no daylight savings mode) NA = North American rules EU = European rules AUS = Australian rules	AN	02	03
ID601	Cash Bag Number	This is the identification of the cash bag or box containing the money removed from the machine	AN	01	20





Identifier	Element Name	Contents	Type	Length Min	Length Max
		by the route person or service engineer.			
ID701	Payment system index	Defines the number of the payment system (beginning with 1) for which the following values are valid. Several payment systems are possible.	AN	01	06
ID702	Payment system Category	Defines the category of payment systems: 0: Coin mech., 1: Coin changer, 2: Token acceptor, 10: Magnetic card system, 11: Chipcard system, 12: Contactless card system, 20: Contact Key system, 21: Contactless Key system, 30: Bill Validator.	AN	01	04
ID703	Manufacturer code	Manufacturer code of the payment system.	AN	01	20
ID704	Serial No.	Serial number of the payment system	AN	01	20
ID705	Model	Modelnumber of the payment system	AN	01	20
ID706	Software revision	Software revision of the payment system	AN	01	20
ID707	Status	Status of payment system: (the right most bit will be sent first) 1. digit: 0 = disabled 1 = enabled 2. digit: revalue enabled 3. digit: Singlevend/Multivend	NO	01	10
ID708	User Defined Field	User Defined Data	AN	01	12
LA101	Pricelist Number	Defines the list number for which the following values are valid. Several Lists possible, to set different prices for each product.	NO	01	01
LA102	Product Number	Equal to the product no. defined in PA101	AN	01	06
LA103	Price	Product price valid for this list number. (If no price is defined for a product number, the price defined in PA102 is to be used).	Nc	01	08
LA104	Number of Vends Since Last Reset	Number of vends of the product on this price list. Resettable.	NO	01	06
LA105	Number Of Vends Since Initialisation	Number of vends of the product on this price list. Non-Resettable	NO	01	08
LC101	Pricelist Number	Configures field LA101	NO	01	01





Identifier	Element Name	Contents	Type	Length Min	Length Max
LC102	Product Number	Configures field LA102	AN	01	06
LC103	Price	Configures field LA103	Nc	01	08
MA101	Machine Serial Number	Serial number of the machine reporting status and configuration data.	AN	01	20
MA102	Single Vend / Multi-vend	Status of single vs. multi vend.	AN	01	20
MA201	Machine Serial Number	Serial number of the machine reporting status and configuration data.	AN	01	20
MA202	VMC Identity / Serial Number	Serial number of the vending machine controller reporting status and configuration data	AN	01	20
MA301	Machine Serial Number	Serial number of the machine reporting status and configuration data.	AN	01	20
MA302	Coin Mechanism Identity	Serial number of the coin mechanism reporting status and configuration data.	AN	01	20
MA401	Machine Serial Number	Serial number of the machine reporting status and configuration data.	AN	01	20
MA402	Debit Card Identity / Serial Number	Serial number of the debit card system reporting status and configuration data.	AN	01	20
MA403	Pricelist Number	Identifies the price list whose card discount is reported.	N0	01	01
MA404	Card Discount	The discount in percent of the standard price.	N0	01	02
MA405	Card Surcharge	Surcharge in %	N0	01	02
MA501	Block Identifier	Sequential block number used for stringing multiple MA5 blocks together. This field should read LAST on the last block in the sequence. MA5 blocks are used together with MA2, MA3 and MA4.	AN	01	12
MA502	Specific Configuration Data	This block contains the specific data coming from the device addressed by the preceding MA2 or MA3 or MA4 block.	AN	01	100
MA503	Optional Field #2	This block contains additional configuration data coming from the device addressed by the preceding MA2 or MA3 or MA4 block.	AN	01	12
MA504	Optional Field #3	This block contains additional configuration data	AN	01	12





Identifier	Element Name	Contents	Type	Length Min	Length Max
		coming from the device addressed by the preceding MA2 or MA3 or MA4 block.			
MA505	Optional Field #4	This block contains additional configuration data coming from the device addressed by the preceding MA2 or MA3 or MA4 block.	AN	01	12
MA506	Optional Field #5	This block contains additional configuration data coming from the device addressed by the preceding MA2 or MA3 or MA4 block.	AN	01	12
MA507	Optional Field #6	This block contains additional configuration data coming from the device addressed by the preceding MA2 or MA3 or MA4 block.	AN	01	12
MA508	Optional Field #7	This block contains additional configuration data coming from the device addressed by the preceding MA2 or MA3 or MA4 block.	AN	01	12
MA509	Optional Field #8	This block contains additional configuration data coming from the device addressed by the preceding MA2 or MA3 or MA4 block.	AN	01	12
MA510	Optional Field #9	This block contains additional configuration data coming from the device addressed by the preceding MA2 or MA3 or MA4 block.	AN	01	12
MA511	Optional Field #10	This block contains additional configuration data coming from the device addressed by the preceding MA2 or MA3 or MA4 block.	AN	01	12
MA601	Product Identifier		AN	01	06
MA602	Water Quantity		N0	01	06
MA603	Water Quantity Cold		N0	01	06
MA604	Water Quantity		N0	01	06
MA605	Water Quantity Short		N0	01	06
MA606	Water Quantity Cleaning Procedure		N0	01	06
MA607	Product Quantity		N0	01	06





Identifier	Element Name	Contents	Type	Length Min	Length Max
MA608	Starttime Product		NO	01	06
MA701	Product Number		AN	01	06
MA702	Syrup Quantity Small		NO	01	06
MA703	Syrup Quantity Big		NO	01	06
MA704	Sodawater Quantity Small		NO	01	06
MA705	Sodawater Quantity Big		NO	01	06
MA706	Water Quantity		NO	01	06
MA707	Starttime Product		NO	01	06
MA801	Shelf Number		AN	01	06
MA802	Shelf Lock Status		NO	01	06
MA803	Deposit		NO	01	06
MA901	Shelf Number		AN	01	06
MA902	Shelf Status		NO	01	06
MC101	Machine Serial Number	Configures field	AN	01	20
MC102	Single Vend / Multi-vend	Configures field	AN	01	20
MC201	Machine Serial Number	Configures field	AN	01	20
MC202	VMC Identity / Serial Number	Configures field MA202	AN	01	20
MC301	Machine Serial Number	Configures field MA301	AN	01	20
MC302	Coin Mechanism Identity / Serial Number	Configures field MA302	AN	01	20
MC401	Machine Serial Number	Configures field MA401	AN	01	20
MC402	Debit Card Identity / Serial Number	Configures field MA402	AN	01	20





Identifier	Element Name	Contents	Type	Length Min	Length Max
MC403	Pricelist Number	Configures field MA403	NO	01	01
MC404	Card Discount	Configures field MA404	NO	01	02
MC405	Card Surcharge	Surcharge in %	NO	01	02
MC501	Block Identifier	Configures field MA501	AN	01	12
MC502	Specific Configuration Data	Configures field MA502	AN	01	100
MC503	Optional Field #2	Configures field MA503	AN	01	12
MC504	Optional Field #3	Configures field MA504	AN	01	12
MC505	Optional Field #4	Configures field MA505	AN	01	12
MC506	Optional Field #5	Configures field MA506	AN	01	12
MC507	Optional Field #6	Configures field MA507	AN	01	12
MC508	Optional Field #7	Configures field MA508	AN	01	12
MC509	Optional Field #8	Configures field MA509	AN	01	12
MC510	Optional Field #9	Configures field MA510	AN	01	12
MC511	Optional Field #10	Configures field MA511	AN	01	12
MC601	Product Identifier	Configures field MA601	AN	01	06
MC602	Water Quantity	Configures field MA602	NO	01	06
MC603	Water Quantity Cold	Configures field MA603	NO	01	06
MC604	Water Quantity	Configures field MA604	NO	01	06
MC605	Water Quantity Short	Configures field MA605	NO	01	06
MC606	Water Quantity Cleaning Procedure	Configures field MA606	NO	01	06
MC607	Product Quantity	Configures field MA607	NO	01	06
MC608	Starttime Product	Configures field MA608	NO	01	06
MC701	Product Identifier	Configures field MA701	AN	01	06
MC702	Syrup Quantity Small	Configures field MA702	NO	01	06
MC703	Syrup Quantoty Big	Configures field MA703	NO	01	06





Identifier	Element Name	Contents	Type	Length Min	Length Max
MC704	Sodawater Quantity Small	Configures field MA704	NO	01	06
MC705	Sodawater Quantity Big	Configures field MA705	NO	01	06
MC706	Water Quantity	Configures field MA706	NO	01	06
MC707	Starttime Product	Configures field MA707	NO	01	06
MC801	Shelf Identifier	Configures field MA801	AN	01	06
MC802	Shelf Lock Status	Configures field MA802	NO	01	06
MC803	Deposit	Configures field MA803	NO	01	06
MC901	Shelf Identifier	Configures field MA901	AN	01	06
MC902	Shelf Status	Configures field MA902	NO	01	06
MR101	Meter Read Number Of Vends Since Initialisation	This value is the meter reading of the total number of vends by the machine, including paid, free and test vends. It is recorded by the route person using a Data Carrier. Non Resettable	NO	01	08
MR102	Meter Read Number Of All Paid Vends Since Initialisation	This value is the meter reading of the total number of paid vends by the machine. It is recorded by the route person using a Data Carrier. Non Resettable	NO	01	08
MR103	Meter Read Number Of Free Vends Since Initialisation	This value is the meter reading of the total number of free vends by the machine. It is recorded by the route person using a Data Carrier. Non Resettable	NO	01	08
MR104	Meter Read Number Of Test Vends Since Last Reset	This value is the meter reading of the total number of test vends by the machine since the last reset. It is recorded by the route person using a Data Carrier. Resettable.	NO	01	08
MR105	Meter Read Number Of Test Vends Since Initialisation	This value is the meter reading of the total number of test vends by the machine. It is recorded by the route person using a Data Carrier. Non Resettable	NO	01	08
MR201	Metered Product Identifier	This value is the product / column number of the meter recording individual product sales. It is recorded by the route person using a Data Carrier.	AN	01	06





Identifier	Element Name	Contents	Type	Length Min	Length Max
MR202	Meter Read Number Of Vends For One Product Since Initialisation	This value is the number of vends for a single product whose number is given by MR201. It is recorded by the route person using a Data Carrier. Non Resettable.	N0	01	08
PA101	Product Identifier	Identifies product to be audited by PA102-PA503. The product (i.e. selection) number should refer to a price line number or machine column designator. This number is defined by the manufacturer.	AN	01	06
PA102	Product Price	The normal vend price of the product.	Nc	01	08
PA103	Product Identification	Product identification should identify the product itself, as in a name (chips / crisps) or an ID number (barcode).	AN	01	20
PA104	Maximum Product Capacity	Largest quantity of this type of product that can be stocked in the machine.	N0	01	04
PA105	Standard Filling Level	Normal filling level of this type of product.	N0	01	04
PA106	Standard Dispensed Quantity	The standard dispensed quantity for each Vend of this product	N0	01	04
PA107	Selection Status	Indicates if the selection motor, actuator, or mechanism is present or if historical (since initialization) data is available. 0 or empty (recommended) = Selection Present (normal) 1 = Selection is not Present (missing / not plugged in) This element is not intended to indicate that a product is unavailable for vending, i.e. Soldout.	N0	01	01
PA108	Current Product Level	Holds the current product filling level and is modified after each product vend and after each refill action	N0	01	04
PA109	Minimum Product Level	Holds the minimum product level that triggers the refill process	N0	01	04





Identifier	Element Name	Contents	Type	Length Min	Length Max
PA201	Number of Products Vended Since Initialisation	The number of products of this type (PA1) vended where the sale is a paid sale. Does not include free vends and test vends. Includes coin, bill, card, discount, free vend token, and zero price vends. Non-Resettable.	N0	01	08
PA202	Value Of Paid Product Sales Since Initialisation	The value of the products of this type (PA1) vended where the sale is a paid sale. Does not include free vends and test vends. Includes coin, bill, card, discount, free vend token, and zero price vends. Non-Resettable.	Nc	01	08
PA203	Num. Of Products Vended Since Last Reset	The number of products of this type (PA1) vended where the sale is a paid sale. Does not include free vends and test vends. Includes coin, bill, card, discount, free vend token, and zero price vends. Resettable	N0	01	06
PA204	Value Of Paid Product Sales Since Last Reset	The value of the products of this type (PA1) vended where the sale is a paid sale. Does not include free vends and test vends. Includes coin, bill, card, discount, free vend token, and zero price vends. Resettable.	Nc	01	08
PA205	Number of Discounted Paid Vends Since Initialisation	This is the number of discounted paid vending sales from all payment sources. Does not include free vends and test vends. Includes coin, bill, card, free vend token, and zero price vends. Non-Resettable.	N0	01	08
PA206	Value of Discounts given Since Initialisation	This is the value of discounts from all payment sources since initialisation. Does not include free vends and test vends. Includes coin, bill, card, free vend token, and zero price vends. Non-Resettable.	Nc	01	08
PA207	Number of	This is the number of discounted paid vending	N0	01	08





Identifier	Element Name	Contents	Type	Length Min	Length Max
	Discounted Paid Vends Since Last Reset	sales from all payment sources. Does not include free vends and test vends. Includes coin, bill, card, free vend token, and zero price vends. Resettable.			
PA208	Value of Discounts Given Since Last Reset	This is the value of discounts from all payment sources. Does not include free vends and test vends. Includes coin, bill, card, free vend token, and zero price vends. Resettable.	Nc	01	08
PA209	Number of Surcharged Vends Paid Since Initialisation	This is the number of surcharged vends from all payment sources. Does not include free vends and test vends. Includes coin, bill, card, free vend token, and zero price vends. Non-Resettable.	N0	01	08
PA210	Value of Surcharges Paid Since Initialisation	This is the value of surcharges collected from all payment sources since initialisation. Does not include free vends and test vends. Includes coin, bill, card, free vend token, and zero price vends. Non-Resettable.	Nc	01	08
PA211	Number of Surcharged Vends Paid Since Last Reset	This is the number of surcharged vends from all payment sources. Does not include free vends and test vends. Includes coin, bill, card, free vend token, and zero price vends. Resettable.	N0	01	06
PA212	Value of Surcharges Paid Since Last Reset	This is the value of surcharges collected from all payment sources. Does not include free vends and test vends. Includes coin, bill, card, free vend token, and zero price vends. Resettable.	Nc	01	08
PA301	Number Of Test Vends Since Initialisation	The number of test vends of this product (PA1) performed. Non-Resettable.	N0	01	08
PA302	Value Of Test Vends Since Initialisation	The value of the test vends of this product (PA1) performed. Non-Resettable.	Nc	01	08





Identifier	Element Name	Contents	Type	Length Min	Length Max
PA303	Number Of Test Vends Since Last Reset	The number of test vends of this product (PA1) performed. Resettable	N0	01	06
PA304	Value Of Test Vends Since Last Reset	The value of the test vends of this product (PA1) performed. Resettable	Nc	01	08
PA401	Number Of Free Vends Since Initialisation	The number of free vends of this product (PA1) performed. Non-Resettable.	N0	01	08
PA402	Value Of Free Vends Since Initialisation	The value of the free vends of this product (PA1) performed. Non-Resettable.	Nc	01	08
PA403	Number Of Free Vends Since Last Reset	The number of free vends of this product (PA1) performed. Resettable	N0	01	06
PA404	Value Of Free Vends Since Last Reset	The value of the free vends of this product (PA1) performed. Resettable	Nc	01	08
PA405	Number of Free Vends without Cups Since Initialization	The number of products of this type (PA1) vended where the sale is a free vend and no cup has been dispensed from the Vending machine (the patron has used own cup). Does not include test vends and zero price vends. Non-Resettable.	N0	01	08
PA406	Number of Free Vends without Cups Since Last Reset	The number of products of this type (PA1) vended where the sale is a free vend and no cup has been dispensed from the Vending machine (the patron has used own cup). Does not include test vends and zero price vends. Resettable.	N0	01	08
PA501	Sold Out Date	The date that this product (PA1) sold out. In some implementations this may be the date of most recent sale.	DT	06	08
PA502	Sold Out Time	The time that this product (PA1) sold out. In some	TM	04	06





Identifier	Element Name	Contents	Type	Length Min	Length Max
		implementations this may be the time of most recent sale.			
PA503	Number of Times Sold Out Product Selected	The number of times a product selection is made when sold out. (Credit is available but not deducted). One count per transaction. Resettable	N0	01	04
PA601	Product Identifier	Identifies product to be audited by PA602-PA606. The product (i.e. selection) number should refer to a price line number or machine column designator. This number is defined by the manufacturer.	AN	01	06
PA602	Product Text	The product (i.e. selection) text should refer to a price line number or machine column designator.	AN	01	20
PA603	VAT Group	VAT group number. 1 out of 4 VAT groups can be selected per price line number or machine column designator.	N0	01	01
PA604	Product Status	Product sales status (price line number or machine column designator). Status=0 means that the sale of the product is blocked. Status=1 means that the product may be sold in a certain period. Status=2 means that the product may be sold any time.	N0	01	01
PA605	Free Vend	The product can be set to free vend (price line number or machine column designator). Free vend=0 means that the product is not set to free vend. Free vend=1 means that the product is delivered free of charge if a payment card is used. Free vend=2 means that the product is delivered free of charge.	N0	01	01
PA606	User Defined Field	User Defined Data	AN	01	12
PA701	Product Number	Identifies product to be audited by PA702-PA708.	AN	01	08





Identifier	Element Name	Contents	Type	Length Min	Length Max
		The product (i.e. selection) number should refer to a price line number or machine column designator. This number is defined by the manufacturer.			
PA702	Payment device	Identifies the payment device that performed vends reported in PA703 – PA708. CA = cash (coin and bill) DA = cashless 1 DB = cashless 2 ...	AN	01	02
PA703	Price list number	Defines the vending machine list number for which the following values are valid. Irrelevant for cash sales, test and free vend. See appl. notes.	N0	01	03
PA704	Applied Price	Specifies the product price for a sale with the parameters PA701 to PA703	Nc	01	08
PA705	Number of sales Since Initialization	The number of products of this type (PA701) vended where the sale is a paid sale. Does not include free vends and test vends. Includes coin, bill, card, discount, surcharge, free vend token, and zero price vends. Non-Resettable.	N0	01	08
PA706	Value of Sales Since Initialization	The value of the products of this type (PA701) where the sale is a paid sale. Does not include free vends and test vends. Includes coin, bill, card, discount, surcharge, free vend token, and zero price vends. Non-Resettable.	Nc	01	08
PA707	Number of sales Since Last Reset	The number of products of this type (PA701) vended where the sale is a paid sale. Does not include free vends and test vends. Includes coin, bill, card, discount, surcharge, free vend token, and zero price vends. Resettable.	N0	01	06
PA708	Value of Sales Since Last Reset	The value of the products of this type (PA701) where the sale is a paid sale. Does not include free	Nc	01	08





Identifier	Element Name	Contents	Type	Length Min	Length Max
		vends and test vends. Includes coin, bill, card, discount, surcharge, free vend token, and zero price vends. Resettable.			
PA801	Number of Mixed Payment Vends Since Initialization	The number of products of this type (PA101) vended where the sale is a mixed paid sale (cash and cashless). Non-Resettable.	N0	01	08
PA802	Value of Mixed Payment Cash Amount Since Initialization	The value of the cash amount paid for products of this type (PA101) where the sale is a mixed sale (cash and cashless). Non-Resettable.	Nc	01	08
PA803	Number of Mixed Payment Vends Since Last Reset	The number of products of this type (PA101) vended where the sale is a mixed paid sale (cash and cashless). Resettable.	N0	01	08
PA804	Value of Mixed Payment Cash Amount Since Last Reset	The value of the cash amount paid for products of this type (PA101) where the sale is a mixed sale (cash and cashless). Resettable.	Nc	01	08
PC101	Product Number	Identifies product to be configured by PC102 - PC106	AN	01	06
PC102	Product Price	Configures field PA102	Nc	01	08
PC103	Product Identification	Configures field PA103	AN	01	20
PC104	Maximum Product Capacity	Configures field PA104	N0	01	04
PC105	Standard Filling Level	Configures field PA105	N0	01	04
PC106	Standard Dispensed Quantity	Configures field PA106	N0	01	04
PC108	Current Product Level	Configures PA108 after each refill action	N0	01	04





Identifier	Element Name	Contents	Type	Length Min	Length Max
PC109	Minimum Product Level	Configures PA109	N0	01	04
PC601	Product Identifier	Identifies product to be configured by PC602 - PC606	AN	01	06
PC602	Product Text	Configures field PA602	AN	01	20
PC603	VAT Group	Configures field PA603	N0	01	01
PC604	Product Status	Configures field PA604	N0	01	01
PC605	Free Vend	Configures field PA605	N0	01	01
PC606	User Defined Field	Configures field PA606	AN	01	12
PC701	Product Number	Identifies product sales parameters to be configured by PC702 – PC704	AN	01	08
PC702	Payment device	Identifies payment device further specified in PC703 – PC704. CA = cash (coin and bill) DA = cashless 1 DB = cashless 2 ...	AN	01	02
PC703	Price list number	Identifies the vending machine price list to be configured in PC704	N0	01	03
PC704	Applied Price	Configures PA704	Nc	01	08
PP101	Preselection Number	Identifies the preselection to be audited by PP102-PP108. This number is defined by the manufacturer.	AN	01	06
PP102	Preselection Price	The normal price of the preselection.	Nc	01	08
PP103	Preselection Identification	Preselection identification should identify the preselection itself, as in a name (sweetner, whitener, etc.) or an ID number (barcode).	AN	01	20
PP104	Preselection Incremental Price	The incremental price for multiple preselections of this type in the same transaction.	Nc	01	06
PP105	Number of Times Preselection Used Since Initialisation	The number of times this preselection has been used since initialisation.	N0	01	06
PP106	Value of Preselection Used	The value of this preselection that has been used since initialisation.	Nc	01	08





Identifier	Element Name	Contents	Type	Length Min	Length Max
	Since Initialisation				
PP107	Number of Times Preselection Used Since Reset	The number of times this preselection has been used since the last reset.	N0	01	06
PP108	Value of Preselection Used Since Reset	The value of this preselection that has been used since the last reset.	Nc	01	08
SA101	Stock Item Identification	Stock item identification should identify the product itself, as in a name (chips / crisps) or an ID number (barcode).	AN	01	20
SA102	Quantity Added To The Machine	This is the quantity of product stocked or added to the machine inventory.	N0	01	06
SA103	Quantity Removed From The Machine	This is the quantity of product manually removed from the machine inventory.	N0	01	06
SA104	Stock Item Machine Price	This is the normal vend price that this item is vended at. (e.g. Price manually entered in Data Carrier)	Nc	01	08
SA105	Stock Item Machine Location	This should identify the column number of where this item is vended from. (e.g. location manually entered in Data Carrier)	AN	01	20
SA106	User Defined Field	User Defined Data	AN	01	12
SA201	Ingredient Number	Defines the ingredient for which the following values are valid.	AN	01	20
SA202	Quantity of Ingredient Vended Since Last Reset	Quantity of ingredient vended since last reset.	N0	01	06
SA203	Quantity of Ingredients Vended Since Initialisation	Quantity of ingredient vended since initialisation.	N0	01	06
SD101	Current Password	This element transmits the security access key currently in use.	AN	01	12
SD102	New Password	This element transmits the new security access key that will be adopted at the end of the session.	AN	01	12





Identifier	Element Name	Contents	Type	Length Min	Length Max
SD103	Reporting Instructions	This command is used to instruct the audit unit which data segments (not individual data elements) are to be reported. Refer to Section 2 for specific details on the use of the SD103 command.	CD	01	100
SD104	Reset Selected Data	This command is used to instruct the audit unit to reset selected data segments (not individual data elements). Refer to Section 2 for specific details on the use of the SD104 command.	CD	01	100
SD105	Reset All Interval Data Control	This command is used to place the audit unit into a mode of operation pertaining to resetting interval audit data. It also is used to instruct the audit unit when to reset interval (since last reset) data elements. AUTO, SAVE, and RESET are the allowable commands. Refer to Section 2 for specific details on the use of the SD105 command.	CD	04	05
SD106	Reset Event(s) Control	This command is used to place the audit unit into a mode of operation pertaining to resetting State 3 events. It also is used to instruct the audit unit when to reset State 3 events. AUTO, SAVE, and RESET are the allowable commands. Refer to Section 2 for specific details on the use of the SD106 command.	CD	04	05
TA101	Token Acceptor Serial Number	Identification number of the token acceptor unit. This number may only be set by the Manufacturer. Note: If payment system accepts coins as well as tokens, use CA101 element instead of TA101	AN	01	20
TA102	Token Acceptor Model Number	Model number or description of the token unit.	AN	01	20
TA103	Token Acceptor Software Revision	Software revision number of the token unit.	N0	01	04
TA104	User Defined Field	User Defined Data	AN	01	12
TA201	Value of Vend Token Vends Since Initialisation	Value of all vend token vends. Non-Resettable.	Nc	01	08





Identifier	Element Name	Contents	Type	Length Min	Length Max
TA202	No. of Vend Token Vends Since Initialisation	Number of all vend token vends Non-Resettable.	N0	01	08
TA203	Value of Vend Token Sales Since Last Reset	Value of all vend token sales. Resettable.	Nc	01	06
TA204	No. of Vend Token Sales Since Last Reset	Number of all vend token sales. Resettable.	N0	01	06
TA205	Value of Value Token Since Initialisation	Value of all value token sales. Non-Resettable.	Nc	01	08
TA206	No. of Value Token Since Initialisation	Number of all value token sales. Non-Resettable.	N0	01	08
TA207	Value of Value Token Sales Since Last Reset	Value of all value token sales. Resettable.	Nc	01	06
TA208	No. of Value Token Vends Since Last Reset	Number of all value token sales. Resettable.	N0	01	06
TA301	Value of Value Tokens In Since Last Reset	Value of all value tokens accepted. Resettable.	Nc	01	08
TA302	Value of Value Tokens In Since Initialisation	Value of all value tokens. Non-Resettable.	Nc	01	08
TA401	Value of Value Tokens Dispensed Since Last Reset	Value of all value tokens dispensed as change plus manually dispensed. Resettable.	Nc	01	08
TA402	Value of Value Tokens Manually Dispensed Since Last Reset	Value of all value tokens manually dispensed. Resettable.	Nc	01	08





Identifier	Element Name	Contents	Type	Length Min	Length Max
TA403	Value of Value Tokens Dispensed Since Initialisation	Value of all value tokens dispensed as change plus manually dispensed. Non-Resettable.	Nc	01	08
TA404	Value of Value Tokens Manually Dispensed Since Initialisation	Value of all value tokens manually dispensed. Non-Resettable.	Nc	01	08
TA405	Number of Vend Tokens Dispensed Since Last Reset	Number of all vend tokens dispensed as change plus manually dispensed. Resettable.	N0	01	06
TA406	Number of Vend Tokens Manually Dispensed Since Last Reset	Number of all vend tokens manually dispensed. Resettable.	N0	01	08
TA407	Number of Vend Tokens Dispensed Since Initialisation	Number of all vend tokens dispensed as change plus manually dispensed. Non-Resettable.	N0	01	08
TA408	Number of Vend Tokens Manually Dispensed Since Initialisation	Number of all vend tokens manually dispensed Non-Resettable.	N0	01	08
TA501	Value of Token Overpay Since Last Reset	Value of value token overpay received. (Inserted money - change paid - vend price = overpay value). Resettable.	Nc	01	08
TA502	Value of Token Overpay Since Initialisation	Value of value token overpay received. (Inserted money - change paid - vend price = overpay value). Non-Resettable.	Nc	01	08
TA601	Value of Value Tokens Filled Since Last Reset	Value of all value tokens manually added to the machine. (filled inventory tubes). Resettable.	Nc	01	08
TA602	Value of Value	Value of all value tokens manually added to the	Nc	01	08





Identifier	Element Name	Contents	Type	Length Min	Length Max
	Tokens Filled Since Initiatlisation	machine. (filled inventory tubes). Non-Resettable.			
TA603	Number of Vend Tokens Filled Since Last Reset	Number of all vend tokens manually added to the machine. (filled inventory tubes). Resettable.	N0	01	06
TA604	Number of Vend Tokens Filled Since Initialisation	Number of all vend tokens manually added to the machine. (filled inventory tubes). Non-Resettable.	N0	01	08
TA701	Token Value	Value of the token being reported on. Value of zero means vend token.	Nc	01	08
TA702	Number of Tokens In Since Last Reset	Number of value token of this value (TA701) accepted. Resettable.	N0	01	06
TA703	No. of Tokens To Cash Box Since Last Reset	Number of value token of this value (TA701) accepted and sent to the cashbox. Resettable.	N0	01	06
TA704	No. of Tokens To Tubes Since Last Reset	Number of value token of this value (TA701) accepted and sent to the inventory tubes Resettable.	N0	01	06
TA705	No. of Tokens In Since Initialisation	Number of value tokens of this value (TA701) accepted. Non-Resettable.	N0	01	08
TA706	No. of Tokens To Cash Box Since Initialisation	Number of value tokens of this value (TA701) accepted and sent to the cashbox. Non-Resettable.	N0	01	08
TA707	No. of Tokens To Tubes Since Initialisation	Number of value tokens of this value (TA701) accepted and sent to the inventory tubes Non-Resettable.	N0	01	08
TA801	Token Value	Value of the token being reported on. Value of zero means vend token.	Nc	01	08





Identifier	Element Name	Contents	Type	Length Min	Length Max
TA802	No. of Tokens Dispensed Since Last Reset	Number of value tokens of this value (TA801) paid out as change plus manually dispensed. Resettable.	N0	01	06
TA803	No. of Tokens Manually Dispensed Since Last Reset	Number of value tokens of this value (TA801) manually dispensed. Resettable.	N0	01	06
TA804	No. of Tokens Dispensed Since Initialisation	Number of value tokens of this value (TA801) paid out as change plus manually dispensed. Non-Resettable.	N0	01	08
TA805	No. of Tokens Manually Dispensed Since Initialisation	Number of value tokens of this value (TA801) manually dispensed. Non-Resettable.	N0	01	08
TA901	Token Value	Value of the token being reported on. Value of zero means vend token.	Nc	01	08
TA902	Number of Tokens Filled Since Last Reset	Number of value tokens of this value (TA901) manually filled. Resettable.	N0	01	06
TA903	Number of Tokens Filled Since Initialisation	Number of value tokens of this value (TA901) manually filled. Non-Resettable.	N0	01	08
TA1001	Token Identification	Identification Number of the Token being reported on.	N0	01	08
TA1002	Token Value	Value of the token. Note that a value of zero means that the token is a vend token.	Nc	01	08
TC101	Token Acceptor Serial Number	Configures field TA101 (not post manufacturer configurable)	AN	01	20
TC102	Token Acceptor Model Number	Configures field TA102 (not post manufacturer configurable)	AN	01	20
TC103	Token Acceptor Software Revision	Configures field TA103 (not post manufacturer configurable)	N0	01	04
TC104	User Defined Field	Configures field TA104	AN	01	12





Identifier	Element Name	Contents	Type	Length Min	Length Max
TC1001	Token Identification	Configures field TC1001	N0	01	08
TC1002	Token Value	Configures field TA1002	Nc	01	08
VA101	Value of All Paid Vends Since Initialisation	This is the value of all paid vending sales from all payment sources since initialisation. Non-Resettable. Free vends and Test vends are not included. Includes coin, bill, card, discount, free vend token, and zero price vends.	Nc	01	08
VA102	Number of All Paid Vends Since Initialisation	This is the number of paid vending sales from all payment sources. Does not include free vends and test vends. Includes coin, bill, card, discount, free vend token, and zero price vends. Non-Resettable.	N0	01	08
VA103	Value of All Paid Sales Since Last Reset	This is the value of all paid vending sales from all payment sources. Free vends and test vends are not included. Includes coin, bill, card, discount, free vend token, and zero price vends. Resettable.	Nc	01	08
VA104	Number of All Paid Vends Since Last Reset	This is the number of all paid vending sales from all payment sources. Free vends and test vends are not included. Includes coin, bill, card, discount, free vend token, and zero price vends. Resettable.	N0	01	06
VA105	Value of All Discounts Given Since Initialisation	This is the value of all discounts awarded by the vending machine controller (does not include discounts applied by a peripheral) from all payment sources since initialisation. Free vends and test vends are not included. Includes coin, bill, card, free vend token, and zero price vends. Non-Resettable.	Nc	01	08
VA106	Number of All Discounted Paid Vends Since Initialisation	This is the number of all discounted paid vending sales awarded by the vending machine controller (does not include discounts applied by a peripheral) from all payment sources. Does not include free vends and test vends. Includes coin,	N0	01	08





Identifier	Element Name	Contents	Type	Length Min	Length Max
		bill, card, free vend token, and zero price vends. Non-Resettable.			
VA107	Value of All Discounts Given Since Last Reset	This is the value of all discounts awarded by the vending machine controller (does not include discounts applied by a peripheral) from all payment sources. Does not include free vends and test vends. Includes coin, bill, card, free vend token, and zero price vends. Resettable.	Nc	01	08
VA108	Number of All Discounted Paid Vends Since Last Reset	This is the number of all discounted paid vending sales awarded by the vending machine controller (does not include discounts applied by a peripheral) from all payment sources. Does not include free vends and test vends. Includes coin, bill, card, free vend token, and zero price vends. Resettable.	N0	01	08
VA109	Number of All Surcharged Vends Since Initialization	This is the number of all surcharged vends from all payment sources. Does not include free vends and test vends. Includes coin, bill, card, free vend token, and zero price vends. Non-Resettable.	N0	01	08
VA110	Value of All Surcharges Collected Since Initialization	This is the value of all surcharges collected from all payment sources since initialisation. Does not include free vends and test vends. Includes coin, bill, card, free vend token, and zero price vends. Non-Resettable.	Nc	01	08
VA111	Number of All Surcharged Vends Since Last Reset	This is the number of all surcharged vends from all payment sources. Does not include free vends and test vends. Includes coin, bill, card, free vend token, and zero price vends. Resettable.	N0	01	06
VA112	Value of All Surcharges Collected Since Last Reset	This is the value of all surcharges collected from all payment sources. Does not include free vends and test vends. Includes coin, bill, card, free vend token, and zero price vends.	Nc	01	08





Identifier	Element Name	Contents	Type	Length Min	Length Max
		Resettable.			
VA201	Test Vend Value Of Sales Since Initialisation	Value of all test vends performed. Non-Resettable.	Nc	01	08
VA202	Number of Test Vends Since Initialisation	Number of all test vends performed. Non-Resettable.	N0	01	08
VA203	Test Vend Value Of Sales Since Last Reset	Value of all test vends performed. Resettable.	Nc	01	06
VA204	Number of Test Vends Since Last Reset	Number of all test vends performed. Resettable.	N0	01	04
VA205	Test Vend Box Cash Since Initialisation	Value of money to the cash box during test vends. Non-Resettable.	Nc	01	08
VA206	Test Vend Box Cash Since Last Reset	Value of money to the cash box during test vends. Resettable.	Nc	01	08
VA301	Free Vend Value of Sales Since Initialisation	Value of all free vends performed. Non-Resettable.	Nc	01	08
VA302	Number of Free Vends Since Initialisation	Number of all free vends performed. Non-Resettable.	N0	01	08
VA303	Free Vend Value Of Sales Since Last Reset	Value of all free vends performed. Resettable.	Nc	01	08
VA304	Number of Free Vends Since Last Reset	Number of all free vends performed. Resettable.	N0	01	06





APPENDIX B - MANUFACTURER CODES

In order to ensure that the Serial Numbering of products does not produce equipment with duplicate numbers, e.g. Two coin mechanisms both serial number 123, or a Vending Machine Control board and a Coin Mechanism both serial number 456, it has been agreed to prefix serial numbers (and fault codes where they do not conform to the standard code) with a three letter manufacturer specific code. The following codes have been reserved for use.

The table below lists the reserved manufacturer codes at the publication date of EVA DTS 6.1.2

The full list of current manufacturer codes is available on the EVA website

www.vending-europe.eu





Manufacturer Codes

3 letter code	Manufacturer Name	Country(s) of Origin
AAS	Alldata	Germany
ABS	Absec	Ireland
ACQ	Acquis AB	Sweden
ADE	Ade Elettronica	Italy
AEP	Advanced Electronic Products	U.S.A
AEQ	Aequator AG Arbon	Switzerland
AGR	AgriaComputer	Hungary
AMS	Adaptive Micro Systems	U.S.A.
ANI	Animo BV	Netherlands
ANT	Antronics Ltd	U.K.
API	Automatic Products	U.S.A.
ARD	Ardac	U.S.A.
ASC	Audit Systems Company	U.S.A.
ASM	Automaten-Seitz	Germany
AST	Astrosystems Ltd	U.K.
ATB	Automatentechnik Baumann	Germany
AUT	Automated Merchandising Systems	U.S.A.
AZK	Azkoyen Comercial	Spain
BBN	Bravilor Bonamat BV	Netherlands
BES	Bassett Electronic Systems Ltd	U.K.
BIW	BiWa	Germany
BKS	Banksys	Belgium





3 letter code	Manufacturer Name	Country(s) of Origin
CAF	Cafection	Canada
CAI	Coin Acceptors International	U.S.A.
CAL	Cale Access AB	Sweden
CAN	Cantaloupe Systems	U.S.A.
CAR	Cardinal	U.K.
CAS	Cashfree Vending	Norway
CBV	Coin Bill Validators	U.S.A.
CCC	The Coca-Cola Company	U.S.A.
CCD	Crane Cash Code	U.S.A.
CCV	CCB Deutschland GmbH	Germany
CDS	CDS Worldwide Pty	Australia
CEL	Celectronic	Germany
CFR	CoinFree	U.S.A.
CHC	Celadon Hailstone Cooperation	Belgium
CLX	Nippon Conlux	Japan
CMS	Crane	U.S.A.
CNV	Crane National Vendors	U.S.A.
COG	Coges	Italy
COL	Coin Controls	U.K.
COM	Comestero Group	Italy
CRO	CroBoCom AS	Norway
DAM	Damian	Italy
DAR	DarenthMJS Ltd	UK
DEB	Debitek	U.S.A.





3 letter code	Manufacturer Name	Country(s) of Origin
DIX	Dixie-Narco	U.S.A.
DJD	J.M. de Jong Duke	The Netherlands
DLG	Distilog	France
DMK	D.M. (Kent) Electronics Ltd.	U.K.
DMS	DMS Tech. Ltd.	Turkey
DNL	Danyl Corporation	U.S.A.
DPS	Direct Payment Solution Limited	New Zealand
DUC	Ducale	Italy
ECT	Etna Coffee Technologies	The Netherlands
EDI	Edu Italia S.p.A.	Italy
ELK	Elkey	Italy
ELM	ELME Elektronische Messgeräte GmbH	Germany
ETI	Ellenby Technologies, Inc	U.S.A.
EVI	Evis AG	Switzerland
EZC	Eazy Coin Corp	USA
FAG	Fage	Italy
FAN	Franchier	Italy
FAS	Fas International	Italy
FEI	FEIG Electronic GmbH	Germany
FIM	Frosh Invent GmbH	Germany
FRA	Franke Kaffeemaschinene AG	Switzerland
FST	Food Automation Systems Technologies, Inc	U.S.A.
FSQ	Four Square Drinks	U.K.
GAT	Gantner Electronic GmbH	Austria





3 letter code	Manufacturer Name	Country(s) of Origin
GDS	General Dispensing Systems	U.K.
GIR	Girovend	U.K.
GMV	GM Vending	Spain
GMX	Gamemax Corporation	U.S.A.
GPA	Grünig-Poth Automaten	Germany
GPE	GPE Vendors	Italy
GUF	Garz&Fricke GmbH	Germany
HAR	Harting Elektronik	Germany
HAW	Hug-Witschi	Switzerland
HEC	Hectronic	Germany
HES	Hesa Innovation GmbH	Germany
HET	Hentel Telecommunication CO, LTD	Taiwan
HOE	Hoefer Elektronik	Germany
HWI	Hans Weinert	Germany
HYC	Hypercom	Germany
IBE	Ibersegur	Spain
IDS	Integrated Dispensing Systems	Australia
IMP	Impulsa Soluciones Tecnológicas	Spain
ING	Ingenico	France
JCM	Japan Cash Machine Co.	Japan
JED	Jede AB	Sweden
JOF	Jofemar	Spain
KBT	Kobetron	U.S.A.
KES	Keso GmbH	Austria





3 letter code	Manufacturer Name	Country(s) of Origin
KRH	KRh Thermal Systems	U.S.A.
KRO	Hypercom	Germany
KSN	Kontrolle-Systeme	Switzerland
LAV	Lavazza	Italy
LGC	Landis&Gyr Communications	Switzerland
LHD	LHD Vending Systems	U.S.A.
LOG	Logos Design A/S	Denmark
MAK	Conlux USA Corporation	U.S.A.
MAS	Maas International	The Netherlands
MAX	Maxtrol Corporation	U.S.A.
MCC	Magna Carta Chip Card Solutions bv	The Netherlands
MCS	MCS Micronic Computer Systeme GmbH	Germany
MEI	Mars Electronics International	UK, U.S.A., Switzerland
MFX	Moneyflex	U.S.A.
MIC	Microtronic	Switzerland
MIK	mikrolab GmbH	Germany
MNM	MNM Automatenbau	Germany
MPX	Maxpax	U.K.
MSC	Microsystem Controls Pty Ltd	U.K.
NAM	NAMA	U.S.A.
NAT	Nagler Automaten Technik GmbH	Germany
NBF	Nuova Bianchi	Italy
NCO	Nippon Conlux	Japan
NEC	Necta Vending Solutions	Italy





3 letter code	Manufacturer Name	Country(s) of Origin
NES	Nestlé Professional	Switzerland
NEW	Newtec Ebert GmbH	Germany
NIS	N&W Innovative Solutions	Italy
NIT	Nitela	Turkey
NRI	National Rejectors Inc.	Germany
NYX	Nayax	Israel
OMN	Omnimatic	Italy
OMR	Omron	Germany
OTR	O.T.R.	Italy
PIL	Planeta Informatica Ltda	Brazil
PJV	Project Vending Srl	Italy
PLF	Profilic Technologies Inc	Canada
PML	Playsafe Monitoring Limited	U.K.
PRA	Pranasys	Uruguay
PRO	Protel, Inc.	U.S.A.
PRT	Protere	Portugal
PSL	Provend Services Limited	U.K.
PTA	PayTec AG	Switzerland
PTV	Politeknik Elektronik	Turkey
QEB	Quality Equipment Benelux B.V.	The Netherlands
RFT	RFTECH SRL	Italy
RHV	Rhea Vendors	Italy
ROE	Roesler	Germany
ROG	Royal Olland Group	The Netherlands





3 letter code	Manufacturer Name	Country(s) of Origin
ROW	Rowe International	U.S.A.
SAD	Sade Group	Turkey
SAE	Saeco Intl Group	Italy
SAG	Sagem Monetel	France
SAR	Schaerer AG	Switzerland
SCH	Schmidt GmbH	Germany
SEL	Selecta	Switzerland
SHP	SUZOHAPP	The Netherlands
SIE	Sielaff	Germany
SIL	Silibit srl	Italy
SIP	Siemens Intelligent Traffic System	Germany
SMA	Smarcom	Switzerland
SMS	Sm solutions GmbH	Germany
SOF	Softel, s.a. de C.V.	Mexico
SPG	Spengler	Germany
STF	Stentorfield	U.K.
SVM	Sanyo Electric Co, Vending Machine Division	Japan
SWR	Streamware Corporation	U.S.A.
TES	Tuttoespresso	Italy
TET	Hypercom	Germany/France
TMG	T M Group	U.K.
TOM	Tommerup Elektronik	Denmark
TRA	Tratécnica	Spain
UNI	Unicum	Russia





3 letter code	Manufacturer Name	Country(s) of Origin
VCS	Versatile Control Systems	U.S.A.
VDK	Vendotek	Czech Republic
VEC	VendingControl Gesellschaft	Germany
VEI	Vendors Exchange International, Inc	U.S.A.
VFI	Verifone International	U.S.A.
VIA	Vianet Group	U.K.
VMI	Veromatic International	The Netherlands
VML	Vending Microcircuits Limited	U.K.
VMV	Vending Machines Verona	Italy
VND	Vendo	U.S.A., Italy
VON	Vendon	Latvia
VST	Verisoft	Turkey
WHM	WH Münzprüfer Dietmar Trenner GmbH	Germany
WIK	Witkowsli GmbH	Germany
WIT	N&W Global Vending	U.K.
WTC	World . Techno Co, Ltd	Japan
WTN	Wittern Group	U.S.A.
WUR	Deutsche Wurlitzer	Germany
WVS	Westomatic Vending Services	U.K.
XCP	XCP/nc	U.S.A.



APPENDIX C - EVENT LIST

C.1 INTRODUCTION

This Appendix C details the current definitions of potential events which can occur in the operation of a vending machine. Some events may only be detected by manually. This would enable operators to use a common approach to recording events. It is intended to supplement the following documents:

An Audit Data Format for the EVA Data Retrieval Standard

An Audit Data Dictionary for the EVA Data Retrieval Standard

In order to minimize the amount of data to be transferred, only the event reference codes are transferred, leaving implementers of machines and data bases free to describe the events as they see fit. Section C.2 details the event lists which have been enhanced in Version 6.0. The Event Lists below may not contain a definition for some specific, yet undefined, event which manufacturers may wish to report. Section C.2.5 defines how manufacturers can add specific codes. However in the general interest of developing a Global standard, EVA and NAMA prefer that requests are made to generate a new code. The process for requesting a new code is described in C.3.

C.2 EVENT LISTS

The event coding system proposed for adoption is comprised of a 3 letter structured code segmented as follows:

<u>First Letter</u>	<u>Second Letter</u>	<u>Third Letter</u>
E - Equipment Event	Unit affected Code	Specific Event Code
O -Operational Event	Operation Affected Code	Specific Event Code



C.2.1 Equipment Event Codes

Unit Codes

Unit Code	Description	Table nr
A	Coin Mechanism	1
B	Cup System	2
C	Control System	3
D	Hot Drinks System	4
E	Brewer/Espresso Unit	5
F	Water System	6
G	Cabinet / Door	7
H	Cold Drink Dispensing System	8
I	Communications	9
J	Food, Snack, or Can/Bottle Systems	10
K	Cashless Systems	11
L	Product	12
M	Microwave	13
N	Bill Validator	14
O	Refrigeration	15



C.2.2 Operational Event Codes

Operation Code	Description	Table nr
A	Operations Request	16
B	Service Related	17
C	Customer induced	18
D	Return Visits	19
E	Machine History	20
F	Cash Collection	21



C.2.3 Specific Event Codes

A number of specific event codes have also been proposed.

Event Code	Description
V	Modifications
W	No Fault Found
X	Client Induced
Y	Service Induced
Z	Other Unlisted Fault

C.2.4 Example Code

To give an example of the use of the proposed event coding system, let us take the case of an Equipment Fault for a Cup Mechanism, which on investigation could not be repeated and is therefore a "No Fault Found" code.

The complete code for this would be: EBW

Where:

- E Equipment
- B Cup System
- W No Fault Found

C.2.5 Manufacturer Specific or New Codes

In addition to the following tables a standardized method for manufacturers to add specific codes has been defined. Any event not listed, but that a manufacturer wants to support should be placed in the appropriate existing table, using the table's two character "General non-specific fault" code followed by an « underscore » and a number code, e.g. for a coin mechanism EA_numbercode. If desired, additional information defining the number code could be included in the EA106 or EA204 user defined elements. The opportunity for , a standard 3 character code to be created to replace an EA_number code if deemed generic enough for global use is described in C.3.



C.2.6 Additional Event Information

Various defined codes pertain to products and the event definition indicates that a product number can be specified. This must be done by adding an « underscore » followed by the product code as specified in the PA101 data element. Examples would be:

EA1*ELA_101*030404*1100 (Product 101 delivery failure)
EA2*ELE_A10*1*4*1 (Product A10 is at low level)

Many defined codes identify events or faults that can apply to one of a number of similar devices in a vending machine (i.e., a valve or motor). To identify which device is being reported, the defined event code can have an « underscore » followed by a number added to it. Below are examples:

EA1*ECH_2*030404*1100 (Opto sensor 2 has malfunctioned)
EA2*EFH_3*1*4*1 (Vend valve 3 is faulty)

If additional information is required to further define the event or fault, text can be added to the EA106 or EA204 user defined elements. Below are examples:

EA1*EH1A_2*030404*1100***OPEN (Thermostat 2 is defective – open circuit)
EA2*ECD*1*1*1*12V LOW (Control board malfunction – 12 volts low)





Table 1: COIN MECHANISM

Event Description	Code	Definition
Coin Mechanism	EA	General non-specific Coin Mechanism fault.
Coin Entry Chute	EAA	A jam has occurred in the coin entry chute of the machine
Reject System or Change Return Cup	EAB	A problem has occurred with the payout at the mech/machine interface.
Accepting Slugs (Foreign Coins)	EAC	Coin mech has detected that a proportion of slugs are being inserted.
Jammed Validator	EAD	A jam has occurred in the coin recognition part of the coin mech.
Jammed Separator	EAE	A jam has occurred in the routing mechanism part of the mech.
Jammed Dispenser	EAF	A jam has occurred in coin payout part of the mech.
Jammed Change giver	EAG	A jam has occurred in an indeterminate part of the changer
Reject Chute	EAH	A jam has occurred in the reject chute under the coin mech.
Cash Box	EAI	A jam has occurred in the entry to the cash box.
Price Setting or Programming Error	EAJ	An error has occurred whilst programming coin mech.
Matrix Box Price Line Error	EAK	An error has occurred whilst programming matrix box.
Failed Validator	EAL	A hard fault has occurred in the coin recognition part of the coin mech.
Failed Separator	EAM	A hard fault has occurred in the routing mechanism part of the mech.
Failed Dispenser	EAN	A hard fault has occurred in the coin recognition part of the coin mech.
Failed Control PCB	EAO	Coin mech control PCB has failed.
Failed Power Supply	EAP	Coin mech power supply has failed.
Credit Display	EAQ	An error has occurred with coin mech credit display.





Event Description	Code	Definition
Comm error	EAR	A comms error has occurred between mech and VMC (or peripheral).
Coin rejected	EAS	Last coin entered has been rejected.
MDB error code	EAU	The error codes will take the form of EAU_xxyy where the xxyy will indicate the hexadecimal equivalent of the Malfunction Error Code reported by the MDB Coin Mechanism. If the xx = 00 then the yy is the Poll response error code. If the xx is anything else the xxyy is the Extended Diagnostic error code. Example – Malfunction Error Code 00001100b (Coin Jam) reported. The event code will be: EAU_000C. MDB Error code follows delimiter « underscore »
Cassette Removed	EA1A	The coin storage cassette has been removed unexpectedly.
Modifications	EAV	Modifications have been made to coin mech setup.
No Fault Found	EAW	No fault was found with coin mech.
Client Induced	EAX	Fault occurred caused by client.
Service Induced	EAY	Fault occurred caused by service technician.
Other Unlisted Fault	EAZ	Fault has occurred which is not listed above.





Table 2: CUP SYSTEM

Event Description	Code	Definition
Cup System	EB	General non-specific Cup Mechanism fault.
Carousel / Turret Fault	EBA	Fault on cup Carousel / Turret
Stack Empty Switch	EBB	Fault on cup stack empty switch.
Cup Detection Switch / Sensor	EBC	Fault on cup detection switch / sensor.
Splitter	EBD	Fault on cup splitting
Cup Transfer Fault or Cup Chute	EBE	Cups failing to arrive in dispense area
Cup Ring Fault	EBF	Defect cup ring.
Faulty Cups	EBG	Faulty or wrong cups in dispenser
Geneva Wheel	EBH	Fault on Geneva Wheel
Cup Arm	EBI	Fault Cup arm/cup transfer
No Cups	EBJ	No Cups in Carousel / Turret. If multiple cup sizes / turrets used, indicate as EBJ_x where x is equal to size / turret number (i.e. EBJ_2)
Cup Transport	EBK	An error has been detected in the cup transport, e.g. elevator, conveyor belt, etc.





	EBL	
Cup Drop Motor / Solenoid	EBM	Faulty motor / solenoid used for dispensing cups.
Cup Index Motor	EBN	Fault on motor used for replenishing cup stack
Modifications	EBV	Modifications has been made to cup mechanism
No Fault Found	EBW	No fault found on cup mechanism
Client Induced	EBX	Client induced cup mechanism fault.
Service Induced	EBY	Service induced cup mechanism fault.
Other Unlisted Fault	EBZ	Other undefined cup mechanism fault.





Table 3: CONTROL SYSTEM

Event Description	Code	Definition
Control System	EC	General non-specific Control System fault.
Power Supply	ECA	One or more of the power supplies are indicating an under or over voltage situation.
Fuses / Overload Switches	ECB	One or more of the fuses / overload switches has tripped.
Transformer	ECC	One or more of the transformers are indicating an under or over voltage situation.
Control PCB	ECD	A malfunction has been detected in the control board.
Relay PCB / Interface PCB	ECE	A malfunction has been detected in the Relay / Interface board.
Loom / Harness Connection Fault	ECF	A malfunction has been detected in a loom (cable) and/or a connection.
Timer Cams	ECG	A malfunction has been detected in one or more of the timer cams.
Opto Sensor	ECH	A malfunction has been detected in one or more of the opto sensors.
Door Switch	ECI	The door switch is stuck open or closed.
Microswitch	ECJ	A malfunction has been detected in one or more of the micro switches.
Ancillary Elec. item	ECK	A malfunction has been detected in one or more of the ancillary electrical items.
Time Clocks	ECL	A malfunction has been detected in the time clock.
Program Memory Error	ECM	An error has been detected in the program memory e.g. EPROM or FLASH.
RAM Error	ECN	An error has been detected in the RAM.
Non Volatile Memory Error	ECO	An error has been detected in the non volatile memory.
Job Queue Full	ECP	The job queue has overrun.
Output Driver Fail	ECQ	An error has been detected in an output driver.
Excessive CPU Resets	ECR	Excessive CPU resets have been detected.





Event Description	Code	Definition
Display PCB	ECS	A malfunction has been detected in the selection display PCB. If the display board is combined with another PCB function (e.g. selection buttons) this is the code that should prevail.
Relay	ECT	A malfunction has been detected in one or more of the relays.
Battery	ECU	The backup battery is low, missing, or not charging.
Electrical Safety	EC1A	The electrical safety is of concern.
Selection Panel / switch / mechanism	EC1B	A malfunction has been detected in the selection panel / switch / mechanism.
Temperature Sensor Error	EC1C	Temperature sensor is defective, disconnected or reading is out of range
No Printer Paper	EC1D	The printer in out of paper.
Vend Counter	EC1E	A malfunction has been detected in the vend counter.
Selection PCB	EC1F	A malfunction has been detected in the selection board.
Product Delivery PCB	EC1G	A malfunction has been detected in the product delivery board.
Modifications	ECV	Modifications has been made to control system
No Fault Found	ECW	No fault found on control system
Client Induced	ECX	Client induced control system fault.
Service Induced	ECY	Service induced control system fault.
Other Unlisted Fault	ECZ	Other undefined control system fault.

Table 4: HOT DRINKS SYSTEM

Event Description	Code	Definition
Hot Drinks System	ED	General non-specific Hot Drinks System fault.





Canister	EDA	One of the ingredient canisters is faulty
Auger / Spiral Mechanism	EDB	Fault on ingredient dispense mechanism
Ingredient Throw	EDC	Incorrect ingredient throw.
Whipper Motor	EDD	Fault on ingredients whipper (mixer) motor.
Whipper Chamber	EDE	Faulty ingredients (mixer) whipper chamber
Delivery Pipes & Mixing Bowls	EDF	Faulty delivery pipes and/or mixing bowl
	EDG	
Ingredient Nozzle	EDH	Faulty ingredient
Ingredient Coil	EDI	Fault on Dosing solenoid
Ingredients Empty	EDJ	One or more of the ingredient canisters is empty
Water Heater Tank	EDK	Fault on boiler (water heater tank)
Heater Fuse	EDL	The boiler (heater element) fuse is blown.
Thermostat	EDM	Faulty boiler control thermostat
H.T. Cut Out	EDN	Cut out operated because of an overboil situation.
Boiler Scale	EDO	Scale in the boiler.
Level Control	EDP	Water Level control in the heater tank faulty
Overflow Pipe	EDQ	Fault on overflow pipe or detected from water tank.
Element Seal	EDR	The heater element seal is defect.
Boiler Shell	EDS	The heater tank is damaged
Grinder	EDT	Fault on grinder
Coffee Doser	EDU	Volumetric Coffee doser faulty
Dispense Head	ED1A	Fault on dispense head
Modifications	EDV	Modifications made to Hot Drinks System
No Fault Found	EDW	No Hot Drinks System fault could be found.
Client Induced	EDX	Client induced Hot Drinks System fault.
Service Induced	EDY	Service induced Hot Drinks System fault.
Other Unlisted Fault	EDZ	Other undefined Hot Drinks System fault.





Table 5: BREWER/ESPRESSO UNIT

Event Description	Code	Definition
Brewer Unit	EE	General non-specific Brewer/Espresso Unit fault.
Brewer Motor	EEA	Fault on Motor for brewer
Scraper Motor	EEB	Fault on Motor for brewer scraper
Filter Plate	EEC	Filter plate blocked or changed or cleaned.
Filter Paper	EED	No filter paper or faulty filter paper.
Scraper Arm	EEE	Fault on brewer scraper arm.
Brew Chamber	EEF	Damaged brew chamber.
Piston	EEG	Damaged piston in brewer
Timer	EEH	Fault in Timer unit for Brewer/Espresso unit
PCB	EEI	Fault on PCB for brewer/espresso unit
Scraper Switch	EEJ	Faulty scraper switch.
Drive Mechanism	EEK	Fault on drive mechanism for Brewer/Espresso unit.
Seals	EEL	Leakage in brewer/espresso unit.
Modifications	EEV	Modification made to Brewer/Espresso Unit
No Fault Found	EEW	No Brewer/Espresso Unit fault could be found.
Client Induced	EEX	Client induced Brewer/Espresso Unit fault.
Service Induced	EEY	Service induced Brewer/Espresso Unit fault.
Other Unlisted Fault	EEZ	Other undefined Brewer/Espresso Unit fault.





Table 6: WATER SYSTEM

Event Description	Code	Definition
Water System	EF	General non-specific Water System fault.
Inlet Pipe	EFA	Fault on water connecting hose
Water Filter	EFB	Water needs to be changed/has been changed.
Inlet Valve	EFC	Faulty Inlet valve
Non-return Valve Delivery Valve	EFD	Fault on non-return .
Regulator	EFE	Faulty Water pressure regulator
Tank	EFF	Header tank fault
Float System	EFG	Error in the water level detection system.
Vend Valve	EFH	Faulty dispense valve
Vend Valve Scale	EFI	Valve needs descaling or has been descaled
Hose / Joint Leak	EFJ	Water leakage in hose or joint.
Probes/holder	EFK	Fault on water level probe assembly
Water Supply Failure	EFL	No water (could be too low water pressure)
Manifold	EFM	Fault on water delivery Manifold or Branch pipe
Water Pump	EFN	Faulty water pump head
Pump Motor	EFO	Faulty water pump motor
Water Quality	EFP	Water quality issue reported
Modifications	EFV	Modifications made to the Water System
No Fault Found	EFW	No Water System fault could be found.
Client Induced	EFX	Client induced Water System fault.
Service Induced	EFY	Service induced Water System fault.
Other Unlisted Fault	EFZ	Other undefined Water System fault.





Table 7: CABINET/DOOR

Event Description	Code	Definition
Cabinet / Door	EG	General non-specific Cabinet Door fault.
Cabinet	EGA	Damage / Fault on cabinet / frame.
Legs	EGB	Missing / Damage to machine legs.
Door / Lock	EGC	Faulty lock / door latching mechanism.
Decals / Labels	EGD	Damage or wrong decals or labels.
Lighting Fault	EGE	Lamps or ballast not working.
Facia / Trim	EGF	Damaged or missing trim.
	EGG	
	EGH	
	EGI	
	EGJ	
Selection Lock / Latch	EGK	
Indicator	EGL	
Drip Tray Assembly	EGM	Drip tray not in place.
Waste Full	EGN	If required specify waste container number, i.e. EGN_2
	EGO	
Extract Fan / Impellor	EGP	Extract fan not working.
Extract Duct	EGQ	Extract duct not in place or blocked.
Extract Motor	EGR	Fault detected on extract motor.
Door Open	EGS	State of door is open.
Door Closed	EGT	State of door is closed.
Vend Door	EGU	Fault on the product delivery/vend door. This may include a solenoid, motor, mechanical binding, or inability to reach the desired position. This includes side moving doors and other internal doors but excludes the delivery assembly door at the bottom of a snack machine (see EJJ).
Modifications	EGV	Modifications have been made.
No Fault Found	EGW	No fault was found
Client Induced	EGX	Fault occurred caused by client.
Service Induced	EGY	Fault occurred caused by service technician.
Other Unlisted Fault	EGZ	Fault has occurred which is not listed above.





Table 8: COLD DRINK DISPENSING SYSTEM

Event Description	Code	Definition
Cold Drink System	EH	General non-specific Cold Drink System fault.
Carbonator Tank	EHC	Leaking, defective or is not being filled to the proper level
	EHE	
Syrup Pump	EHF	Defective or clogged syrup pump
Syrup Valve	EHG	Defective or clogged syrup valve
Syrup Pipe	EHH	Defective or clogged syrup pipe
Syrup Canister Container	EHI	Container is out of syrup or defective.
Syrup O Ring / Seal	EHJ	Defective or leaking
CO2 Bottle	EHK	CO2 pressure is low or empty. Defective CO2 Bottle
CO2 Regulator / Adjust CO2	EHL	CO2 pressure level is outside of acceptable range. Adjust or replace regulator.
CO2 / Water Leak	EHM	CO2 or water is leaking
CO2 Pipe	EHN	Defective or clogged CO2 pipe
CO2 Gauge	EHO	Pressure indication is not correct
CO2 Gauge O Ring	EHP	O ring defective
Ice/Water Bath	EHT	Bath is too warm or has frozen
Bath Agitator Motor	EHU	Motor has failed
Bath Cold Thermostat	EH1A	Defective thermostat
Bath Level Control	EH1B	Water level in the bath is too low
Carbonator Water Pump	EH1C	Defective pump
Ice Maker door solenoid	EH1K	Ice Maker door solenoid
Ice Maker level switch	EH1L	Defective switch
Ice Maker auger motor	EH1M	Defective or jammed. Frozen ice may be preventing auger operation .





Event Description	Code	Definition
Carbonator value	EH1N	Value is clogged or Defective
Carbonator level sensors	EH1O	Defective, may be indicating both high and low level at the same time
Feeder Cup level sensors	EH1P	Defective, may be indicating both high and low level at the same time
Feeder Cup empty	EH1Q	The feeder cup has less than the required minimum amount of water in it.
Water path cleaning system	EH1R	The cleaning system is defective
Modifications	EHV	Modifications have been made.
No Fault Found	EHW	No fault was found.
Client Induced	EHX	Fault occurred caused by client.
Service Induced	EHY	Fault occurred caused by service technician.
Other Unlisted Fault	EHZ	Fault has occurred which is not listed above.

NOTES:

- 1) There can be multiple CO2 regulators in the case of a Bag in a Box machine.
- 2) There are multiple syrup canisters. Error EHI.





Table 9: COMMUNICATIONS

Event Description	Code	Definition
Communications	EI	General non-specific Communications fault.
No Modem / Radio Facility	EIA	No modem / radio detected in system.
Telephone Line Failure	EIB	Modem has detected that the telephone line is not working (e.g. no dial tone).
Low Comms Battery	EIC	The Comms Gateway's battery, or back-up power source, is low and in risk of going flat.
Remote Machine Comms Error	EID	The remote host had a communications error, e.g. not synchronizing, continuous dropped call, etc.
No WAN Coverage	EIE	No WAN network detected. If WAN is a wireless network then Comms Gateway is out of coverage or there is an antenna problem.
No LAN Coverage	EIF	No LAN network detected. If LAN is a wireless network then Audit Unit is out of coverage, is not properly configured to communicate with the network, or has an antenna problem.
Remote Host Busy	EIG	The remote host is busy, communication could not be established.
Communication Denied by Network	EIH	Comms Gateway is in coverage but the network is not allowing unit to perform transmissions (e.g. unit is not registered with network provider, address collisions on a LAN, etc.).
Communication Denied by Remote Host	EII	Remote host is reachable through the network but is denying communications with the Comms Gateway.
Comms Gateway Not Commissioned	EIJ	Comms Gateway has not been registered (commissioned) with the remote host.
Communication Reliability Low	EIK	Successful transmissions (from Comms Gateway to remote host) have fallen below 80% of total transmission attempts over the last 30 days.
VMC Not Responding	EIL	The Comms Gateway reported it can not establish a data transfer session with the VMC.
No VMC Data Transfer Port	EIM	The Comms Gateway reported it does not sense the presence of a connection to the VMC's data transfer port.





Connection		
Weak Radio Signal Strength Indicator	EIN	The Comms Gateway can detect a network signal, but it is below an optional level for reliable communications. This level is set by the communications technology.
Comms Gateway to VMC communication error	EIO	The VMC reported a communication error has occurred between VMC and the Comms Gateway.
Modifications	EIV	Modifications have been made.
No Fault Found	EIW	No fault was found.
Client Induced	EIX	Fault occurred caused by client.
Service Induced	EIY	Fault occurred caused by service technician.
Other Unlisted Fault	EIZ	Fault has occurred which is not listed above.





Table 10: FOOD, SNACK, OR CAN/BOTTLE SYSTEM

Event Description	Code	Definition
Food, Snack, or Can/Bottle System	EJ	General non-specific Food & Snack System fault.
Vend Door Error	EJA	Not for new designs, see Table 7, EGU. A door error exists: This may include a solenoid, motor problem, mechanical binding, or not able to reach the desired position. This includes side moving doors and other internal doors but excludes the delivery assembly door at the bottom of a snack machine.
Dispense Motor	EJB	Errors exist on a product dispense motor which may include motor jammed, motor not home, coupling error, defective motor, or wiring error.
Candy/Chain/Helix Assembly.	EJC	Helix/chain is blocked or helix is not inserted proper.
Shelves / Drawers / Trays	EJD	One of the shelves is not properly connected/inserted. Shelf is not installed properly, or is defective.
Drum Mechanism (Food)	EJE	The drum mechanism does not turn correctly.
Drum Motor (Food)	EJF	The motor driving the drum is defective.
Delivery / Door Assembly	EJG	The delivery/door assembly is not operating properly. This is typically the area at the bottom of a snack machine where the customer reaches inside to get the product.
Health Timer	EJH	The Health rules have been violated for the temperature controlled section. Dependant upon the regional rules, the food section may be Out of Service (food may not be served)
Fans	EJI	One of the fans is defective.
Refrigeration	EJJ	The cooling unit does not cool down to the pre-set temperature or the unit has frozen up
Thermostat	EJK	The Thermostat is defective.
Product delivery detector error	EJL	The product delivery detection system has an error.
Product Delivery System	EJM	An error has been detected in the product delivery system, e.g. elevator, arm, conveyor belt, etc.





Modifications	EJV	Modifications have been initialized at the machine.
No Fault Found	EJW	Machine was inspected but no fault found.
Client Induced	EJX	Fault was induced by a client due to vandalism or fraud.
Service Induced	EJY	A service is necessary.
Other Unlisted Fault	EJZ	All non-specialized faults that are not covered by the above list.





Table 11: CASHLESS 1 SYSTEM

Event Description	Code	Definition
Cashless 1 Systems	EK	
Card Reader	EKA	Cashless System contacting unit defective
Control Unit	EKB	Error on card reader control unit detected
Control PCB	EKC	Cashless System control PCB has failed.
Failed Power Supply	EKD	Cashless System power supply has failed.
Card Rejected	EKE	Card rejected because of error (see details below)
Programming	EKF	Cashless System parameter programming incorrect
Card not programmed	EKG	Card not yet ready programmed for use
Card expired	EKH	Card validation date has expired
Card blocked	EKI	Card is blocked due to errors or corruption
Card rejected, marked in hotlist	EKJ	Card number is in hot list
Memory full, read-out data	EKK	Transaction memory capacity expired
Security module (SIM-Card)	EKL	SIM card defective or not valid any more
Comm error	EKM	A communication error has been detected and / or all communications has stopped.
MDB Error Code	EKU	The error codes will take the form of EKU_xx where the xx will indicate the hexadecimal equivalent of the Malfunction Error Code reported by the MDB Cashless System. Example – Malfunction Error Code 0100yyyyb (Communications Error) reported, the data in yyyy is the manufacture defined subcode and will vary. The event code will be: EKU_4X. MDB Error code follows delimiter « underscore »
Modifications	EKV	Modifications have been made.
No Fault Found	EKW	No fault was found with Cashless 1 System
Client Induced	EKX	Fault occurred caused by client.
Service Induced	EKY	Fault occurred caused by service technician.
Other Unlisted Fault	EKZ	Fault has occurred which is not listed above.





TABLE 11a: CASHLESS 2 SYSTEMS

Event Description	Code	Definition
Cashless 2 Systems	EK2	
Card Reader	EK2A	Cashless System contacting unit defective
Control Unit	EK2B	Error on card reader control unit detected
Control PCB	EK2C	Cashless System control PCB has failed.
Failed Power Supply	EK2D	Cashless System power supply has failed.
Card Rejected	EK2E	Card rejected because of error (see details below)
Programming	EK2F	Cashless System parameter programming incorrect
Card not programmed	EK2G	Card not yet ready programmed for use
Card expired	EK2H	Card validation date has expired
Card blocked	EK2I	Card is blocked due to errors or corruption
Card rejected, marked in hotlist	EK2J	Card number is in hot list
Memory full, read-out data	EK2K	Transaction memory capacity expired
Security module (SIM-Card)	EK2L	SIM card defective or not valid any more
Comm error	EK2M	A communication error has been detected and / or all communications has stopped.
MDB Error Code	EK2U	The error codes will take the form of Eku_xx where the xx will indicate the hexadecimal equivalent of the Malfunction Error Code reported by the MDB Cashless System. Example – Malfunction Error Code 0100yyyyb (Communications Error) reported, the data in yyyy is the manufacture defined subcode and will vary. The event code will be: Eku_4X. MDB Error code follows delimiter « underscore »
Modifications	EK2V	Modifications have been made.
No Fault Found	EK2W	No fault was found with Cashless 2 System
Client Induced	EK2X	Fault occurred caused by client.
Service Induced	EK2Y	Fault occurred caused by service technician.
Other Unlisted Fault	EK2Z	Fault has occurred which is not listed above.





Table 12: PRODUCT

Event Description	Code	Definition
Product	EL	General non-specific Product fault.
Product Delivery Failure	ELA	Vending Machine failed to dispense the choosen product. If required specify product No.(x): ELA_x
Product Sold Out Unexpectedly	ELB	No choosen product left. If required specify product No.(x): ELB_x
Water Dispense Quantity	ELC	Dispensed quantity exceeds preset range. If required specify product No.(x): ELC_x
Syrup Dispense Quantity	ELD	Dispensed quantity exceeds preset range. If required specify product No.(x): ELD_x
Product at low level	ELE	Number / level of product at alarm level. If required specify product No.(x): ELE_x
Modifications	ELV	Modifications have been made.
No fault found	ELW	No fault was found
Client Induced	ELX	Fault occurred caused by client.
Service Induced	ELY	Fault occurred caused by service technician.
Other Unlisted Fault	ELZ	Fault has occurred which is not listed above.

The "x" following the « underscore » indicates the product number as defined in the PA101 data element. Examples are:

EA2*ELB_A3****1 (Product number A3 is sold out)

EA2*ELC_103*4*25**0 (Water quality for product 103 had exceeded preset range four times since last reset)





Table 13: MICROWAVE

Event Description	Code	Definition
Microwave	EM	General non-specific Microwave fault.
Emission Check	EMA	Emission check conducted.
Magnetron fault	EMB	Faulty magnetron reported.
Control System fault	EMC	Faulty microwave control system reported.
Modifications	EMV	Modifications have been made.
No Fault Found	EMW	No fault was found
Client Induced	EMX	Fault occurred caused by client.
Service Induced	EMY	Fault occurred caused by service technician.
Other Unlisted Fault	EMZ	Fault has occurred which is not listed above.





Table 14: BILL VALIDATOR

Event Description	Code	Definition
Bill Validator	EN	General non-specific Bill Validator fault.
Bill Entry	ENA	The bill entry path is blocked.
Detecting Frauds	ENB	Excessive frauds are being detected.
Jammed Validator	ENC	The validator recognition path is jammed.
Jammed Stacker	END	The stacker mechanism is jammed.
Bill / Cash Box Full	ENE	The bill / cash box is full.
Bill / Cash Box Removed	ENF	The bill / cash box is removed or not seated properly.
Failed Validator	ENG	The validator recognition system has failed.
Failed Stacker	ENH	The stacker mechanism has failed.
Failed Control Board	ENI	An error condition has been detected on the control board.
Failed Power Supply	ENJ	An error condition has been detected on one or more of the power supplies.
Comm Error	ENK	A communication error has been detected and / or all communications has stopped.
MDB Error Codes	ENU	The error codes will take the form of ENU_xx where the xx will indicate the hexadecimal equivalent of the Status Code reported by the MDB bill validator. Example – MDB status code 00000100b (ROM Checksum Error) reported. The event code will be: ENU_04. MDB Error code follows delimiter « underscore »
Modification	ENV	Modifications have been made.
No Fault Found	ENW	No fault was found
Client Induced	ENX	Fault occurred caused by client.
Service Induced	ENY	Fault occurred caused by service technician.
Other unlisted operation request	ENZ	Fault has occurred which is not listed above.





Table 15: REFRIGERATION SYSTEM

Event Description	Code	Definition
Refrigeration System	EO	General non-specific Refrigeration System fault.
Temperature sensor	EOA	Failed sensor or incorrect reading
Compressor Controller	EOB	Defective relay or triac causing compressor to run continuously or not start
Compressor	EOC	Errors include: leaks, doesn't run , reduced capacity or tripping due to overload
Compressor current Operating Relay or PTC (positive thermal coefficient)	EOD	Defective or stuck current relay or PTC
Compressor High Temperature Trip	EOE	Failed trip mechanism
Compressor Capacitor	EOF	Failed capacitor, compressor won't start
Capillary tube	EOG	Internal restriction or kinked tube
Condenser	EOH	Has leaks or air is restricted because of dirt/debris
Condenser Fans	EOI	Bent fan blade or fan motor failure
Evaporator	EOJ	Has leaks or air is restricted because of dirt/debris or frozen
Evaporator motor	EOK	Evaporator fan motor failure
Expansion Valve	EOL	Failed expansion valve
Refrigerant Leak	EOM	Refrigerant is leaking
Defrost Controller	EON	Defective relay or triac
Defrost Temperature Cutout switch	EOO	Defective switch
Defrost Heaters	EOP	Defective Heaters
Condensate overflow or leak	EOQ	Defective condensate pan or evaporator pan, or restricted drain tube





Event Description	Code	Definition
Modifications	EOV	Modifications have been made.
No Fault Found	EOW	No fault was found
Client Induced	EOX	Fault occurred caused by client.
Service Induced	EOY	Fault occurred caused by service technician.
Other Unlisted Fault	EOZ	Fault has occurred which is not listed above.

NOTE: If there are multiple refrigeration systems then a number should be appended to the error to indicate which system had the failure, example: EOA1.

Table 16: OPERATIONS REQUEST

Manually induced events for steering and reporting purpose.

Event Description	Code	Definition
Operations Request	OA	General non-specific Operations Request fault.
Maintenance	OAA	Maintenance services (some specific services are listed below)
Inspecting Equipment / Quality Check	OAB	Inspecting and checking Product / Function / Service
Deliver Machine	OAC	Delivery to the customer
Deliver/install Machine	OAD	Delivery and installation at the customer site
Install Machine	OAE	Installation at the customer site
Exchange Machine	OAF	Replace a machine at the customer by another machine
Collect Machine	OAG	Collect from the customer site
Resite Machine	OAH	Move the machine from one place at the customer to another
Staff Training	OAI	Training of operations staff
Sanitizing	OAJ	Sanitizing the vending machine
Filter Change	OAK	Water filter change
Price Change	OAL	If required specify product No.(x): OAL_x





Machine Recipe Altered / Ingredient Adjusted	OAM	If required specify product No.(x): OAM_x
Meter Check	OAN	Check ingredience quantity according the recipe
CO2 Change	OAQ	Replace used bottle by full bottle
Loss Check	OAP	Action required due to any kind of loss
De-greasing	OAQ	Brewer de-greasing
Sterilizing	OAR	For higyene purpose
Collect Authorities Reporting Data	OAS	Reporting to country specific or local authorities
Product Change	OAT	If required specify product No.(x): OAT_x
Start Promotion	OAU	If required specify product No.(x): OAU_x
End Promotion	OA1A	If required specify product No.(x): OA1A_x
All Products filled up to restock level	OA1B	All Products are filled to the required restock level
Product filled up to restock level	OA1C	Specific Product is filled to the required restock level. Specify product No.(x): OA1C_x
Modification	OAV	
No Fault Found	OAW	
Client Induced	OAX	
Service Induced	OAY	
Other unlisted operation request	OAZ	

Application Note: Activity has to be done, when Event Status =1 (active)
 Activity has been finished, when Event Status =0 (inactive)

The "x" following the « underscore » indicates the product number as defined in the PA101 data element.





Table 17: SERVICE RELATED

Event Description	Code	Definition
Service Related	OB	General non-specific Service Related fault.
Incorrect Loading	OBA	Wrong product, place, quantity, spiral position, ... (some specific situations are listed below)
Door Left Open	OBB	Left open by mistake
Product Low / Empty	OBC	Quantity not sufficient until next regular visit (estimation). If required specify product No.(x): OBC_x
Cups Low / Empty	OBD	Quantity not sufficient until next regular visit (estimation).
Product Faulty	OBE	Packaging, quality, ingredients, additives, out of date, temperature, etc.
Cups Faulty	OBF	Broken, blocked, wrong size, wrong type
CO2 Low / Empty	OBG	Quantity not sufficient until next regular visit (estimation).
Bucket full or out of place	OBH	Waste bucket not in correct position or necessary to empty
Pipe out of place	OBI	Waste water pipe not in correct position
Wrong Price	OBJ	If required specify product No.(x): OBJ_x
No/ Incorrect Change	OBK	Change giver
Incorrect Assembly	OBL	Wrong position, bad positioned, not or not properly connected
Service Needed	OBM	Induced by customer, consumer, operator
Extract Duct Blocked	OBN	If required specify product No.(x): OBN_x
Cash Box Full	OBO	Coins and/or bills and/or tokens
Dirty Coin Unit	OBP	Low, wrong or no coin and/or tokens acceptance
Dirt Blocking Pipe	OBQ	If required specify product No.(x): OBQ_x
Dirty Bill Unit	OBR	Low, wrong or no bill acceptance
Value Carrier refused	OBS	Cashless device refuses value carriers unexpectedly
Cooling	OBT	Insufficient cooling: Temperature of cold drinks and/or (liquid) ingredients and/or food is too high (or





		eventually too low)
Modification	OBV	
No Fault Found	OBW	
Client Induced	OBX	
Service Induced	OBY	
Other unlisted service related actions	OBZ	

For automatically detectable events, see related chapter

Specify product number following delimiter « underscore »

The “x” following the « underscore » indicates the product number as defined in the PA101 data element.





Table 18: CUSTOMER INDUCED

Event Description	Code	Definition
Customer Induced	OC	General non-specific Customer Induced fault.
Theft	OCA	Machine forced, cash box, money or products stolen
Vandalism Damage	OCB	Parts broken, spilled, destroyed, graffiti, etc. done on purpose...
Coin Path Blocked	OCC	Slot coinmech blocked (chewing gum, self made coins, dirt, ...)
Liquid Spillage	OCD	Soup, coffee or other liquid products are spilled in the vending machine
Bill Path Blocked	OCE	Slot bill reader blocked (cards, paper, ...)
Power Supply Interrupted	OCF	Machine out of order due to power failure
Water supply Interrupted	OCG	Products prepared with water are not available
Access to Machine Obstructed	OCH	Consumer, operator or technician has no or insufficient access to vending machine
Cheating Trials	OCI	Multiplying money (fraud) in order to get products for free or a lower price, ...
Customer Communication Network Interrupted	OCJ	No access to customer database (central credit or debit), server shut down, ...
External Communication Network Interrupted	OCK	No communication between operator's communication tool and vending machine
Wrong Programming of Payment Media	OCL	Identification media or value carrier are not or wrong programmed
System Operating Failure	OCM	Vending machine not ready to sale due to system operating failure
System Configuring Failure	OCN	Vending machine not ready to sale due to system configuring failure
Other	OCZ	

For automatically detectable events, see related chapter





Table 19: RETURN VISITS

Event Description	Code	Definition
Return Visits	OD	General non-specific Return Visits fault.
Part Fitted	ODA	If required specify part x: ODA_x
Coin Unit Replaced	ODB	
Cold Unit Replaced	ODC	
Vandalism Repair	ODD	If required specify repair job (x): ODD_x
PR Visit	ODE	If required specify public relations job (x): ODE_x
Check Previous Work	ODF	If required specify previous work (x): ODF_x
Other	ODZ	

Use delimiter « underscore » for further proprietary specification

Table 20: MACHINE HISTORY

Event Description	Code	Definition
Machine History	OE	General non-specific Machine History fault.
Out of Hours Call	OEA	Event detection outside office hours of the service/operating company
Coin Conversion	OEB	Coin configuration change giver
Other	OEZ	





Table 21: CASH COLLECTION

Event Description	Code	Definition
Cash Collection	OF	General non-specific Cash Collection fault.
Coins	OFA	Coin and/or token box emptied
Bills	OFB	Bill box / stacker emptied
Cashless	OFC	Audit data delivered to clearing center (electronic purse, mobile payment)
Tubes	OFD	Tubes emptied



C.3. PROCESS FOR MAINTAINING EVENT LIST

The current Event List will be published on the EVA web site.

Request for the creation of new codes should be sent to EVA at:

vending@vending-europe.eu

Each request should have the following information :

Name of Requesting Company

Contact Person

Unit Code – Define which system to which the event is relevant

Definition of the New event – as much detail as possible

Each request will be circulated to the Standards Committee of the EVA and the Technical Working Group of NAMA and a response will be provided within 6 working weeks. If the new Event is defined it will be added to the list maintained on the EVA web site.





APPENDIX D – CHANGES IN VERSION 6.1.2

D.1. EXPLANATION OF VERSION 6.1.2

According to the definitions contained within the standard each release of EVA-DTS is known as a version. Each version consists of a level and a revision number, thus Version 6.1.2 is equal to level six, revision 1, amendment 2.

D.2. APPLICATION NOTES DATA

In chapter 5 under subchapter 5.3, Version 6.1.2 adds “Application Notes for General Accepted Accounting Principles (GAAP).” This application note was adopted to show and clarify the usage of this standard (these principles apply since version 4.1) with existing vending machines, in order to comply with potential new security and tax rules by national governments.



APPENDIX E - CHANGE PROCEDURE

The EVA-DTS Standard is maintained and developed jointly by the EVA Standards Committee and the NAMA Technical Standards Committee.

Any comments, requests for assistance or changes should be addressed to either of the following

EUROPEAN VENDING ASSOCIATION (EVA)

Rue Van Eyck 44
1000 Brussels - Belgium

Tel: +32 2 512 00 75

Fax: +32 2 502 23 42

E-mail: vending@european-vending.eu

NAMA

Headquarters

20 North Wacker Drive, Suite 3500
Chicago, IL 60606-3102 - USA

Tel: +1 312.346.0370

Fax: +1 312.704.4140

E-mail: info@vending.org

Dependent on the nature of the request, the issue raised will be forwarded to both of the above working groups.

After consideration of the issue if the request requires a modification to the standard, the activity will be added to the work list for the committees and amendments published in a revised issue of the standard.

