

Tire Information
Supplement
and
Manufacturers
Warranties

TABLE OF CONTENTS

TIRE INFORMATION SUPPLEMENT	4
BFGOODRICH TIRES	27
BRIDGESTONE® - FIRESTONE®	45
CONTINENTAL TIRE	87
FALKEN TIRE CORPORATION	95
GENERAL TIRE	113
GOODYEAR DUNLOP TIRES	121
HANKOOK TIRES	137
KUMHO TIRES	143
MICHELIN	157
NEXEN TIRE	185
PIRELLI TIRES	195
TOYO TIRES – LIMITED WARRANTY	215
YOKOHAMA TIRES — LIMITED WARRANTY	257

**TIRE
INFORMATION
SUPPLEMENT**

TIRES

TIRES

Tire Safety Information

Tire safety information will cover aspects of the following information: Tire Markings, Tire Identification Numbers, Tire Terminology and Definitions, Tire Pressures, and Tire Loading.

Tire Markings

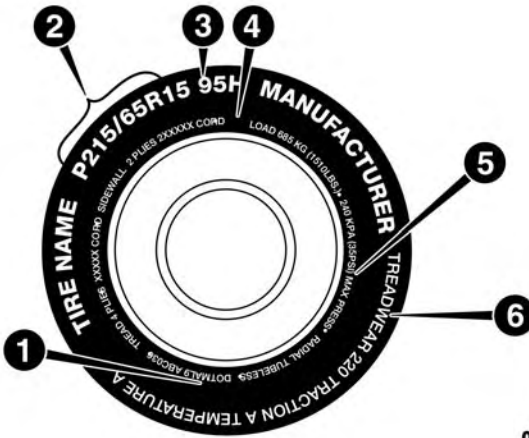

0601085395US

Tire Markings

- | | |
|--|--|
| 1 — U.S. DOT Safety Standards Code (TIN) | 4 — Maximum Load |
| 2 — Size Designation | 5 — Maximum Pressure |
| 3 — Service Description | 6 — Treadwear, Traction and Temperature Grades |

NOTE:

- P (Passenger) — Metric tire sizing is based on U.S. design standards. P-Metric tires have the letter "P" molded into the sidewall preceding the size designation. Example: P215/65R15 95H.
- European — Metric tire sizing is based on European design standards. Tires designed to this standard have the tire size molded into the sidewall beginning with the section width. The letter "P" is absent from this tire size designation. Example: 215/65R15 96H.

- LT (Light Truck) — Metric tire sizing is based on U.S. design standards. The size designation for LT-Metric tires is the same as for P-Metric tires except for the letters “LT” that are molded into the sidewall preceding the size designation. Example: LT235/85R16.
- Temporary spare tires are designed for temporary emergency use only. Temporary high pressure compact spare tires have the letter “T” or “S” molded into the sidewall preceding the size designation. Example: T145/80D18 103M.
- High flotation tire sizing is based on U.S. design standards and it begins with the tire diameter molded into the sidewall. Example: 31x10.5 R15 LT.

Tire Sizing Chart

EXAMPLE:

Example Size Designation: P215/65R15XL 95H, 215/65R15 96H, LT235/85R16C, T145/80D18 103M, 31x10.5 R15 LT

P = Passenger car tire size based on U.S. design standards, or

“...blank...” = Passenger car tire based on European design standards, or

LT = Light truck tire based on U.S. design standards, or

T or S = Temporary spare tire or

31 = Overall diameter in inches (in)

215, 235, 145 = Section width in millimeters (mm)

65, 85, 80 = Aspect ratio in percent (%)

– Ratio of section height to section width of tire, or

10.5 = Section width in inches (in)

R = Construction code

– “R” means radial construction, or

– “D” means diagonal or bias construction

15, 16, 18 = Rim diameter in inches (in)

Service Description:

95 = Load Index

– A numerical code associated with the maximum load a tire can carry

H = Speed Symbol

– A symbol indicating the range of speeds at which a tire can carry a load corresponding to its load index under certain operating conditions

– The maximum speed corresponding to the speed symbol should only be achieved under specified operating conditions (i.e., tire pressure, vehicle loading, road conditions, and posted speed limits)

TIRES

EXAMPLE:

Load Identification:

Absence of the following load identification symbols on the sidewall of the tire indicates a Standard Load (SL) tire:

- **XL** = Extra load (or reinforced) tire, or
- **LL** = Light load tire or
- **C, D, E, F, G** = Load range associated with the maximum load a tire can carry at a specified pressure

Maximum Load – Maximum load indicates the maximum load this tire is designed to carry

Maximum Pressure – Maximum pressure indicates the maximum permissible cold tire inflation pressure for this tire

Tire Identification Number (TIN)

The TIN may be found on one or both sides of the tire; however, the date code may only be on one side. Tires with white sidewalls will have the full TIN, including the date code, located on the white sidewall side of the tire. Look for the TIN on the outboard side of black sidewall tires as mounted on the vehicle. If the TIN is not found on the outboard side, then you will find it on the inboard side of the tire.

EXAMPLE:

DOT MA L9 ABCD 0301

DOT = Department of Transportation

- This symbol certifies that the tire is in compliance with the U.S. Department of Transportation tire safety standards and is approved for highway use

MA = Code representing the tire manufacturing location (two digits)

L9 = Code representing the tire size (two digits)

ABCD = Code used by the tire manufacturer (one to four digits)

03 = Number representing the week in which the tire was manufactured (two digits)

- 03 means the 3rd week

01 = Number representing the year in which the tire was manufactured (two digits)

- 01 means the year 2001

- Prior to July 2000, tire manufacturers were only required to have one number to represent the year in which the tire was manufactured. Example: 031 could represent the 3rd week of 1981 or 1991

Tire Terminology And Definitions

Term	Definition
B-Pillar	The vehicle B-Pillar is the structural member of the body located behind the front door.
Cold Tire Inflation Pressure	Cold tire inflation pressure is defined as the tire pressure after the vehicle has not been driven for at least three hours, or driven less than 1 mile (1.6 km) after sitting for a minimum of three hours. Inflation pressure is measured in units of PSI (pounds per square inch) or kPa (kilopascals).
Maximum Inflation Pressure	The maximum inflation pressure is the maximum permissible cold tire inflation pressure for this tire. The maximum inflation pressure is molded into the sidewall.
Recommended Cold Tire Inflation Pressure	Vehicle manufacturer's recommended cold tire inflation pressure as shown on the tire placard.
Tire Placard	A label permanently attached to the vehicle describing the vehicle's loading capacity, the original equipment tire sizes and the recommended cold tire inflation pressures.

TIRES

Tire Loading And Tire Pressure

NOTE: The proper cold tire inflation pressure is listed on the driver's side B-Pillar or the rear edge of the driver's side door.

Check the inflation pressure of each tire, including the spare tire (if equipped), at least monthly and inflate to the recommended pressure for your vehicle.

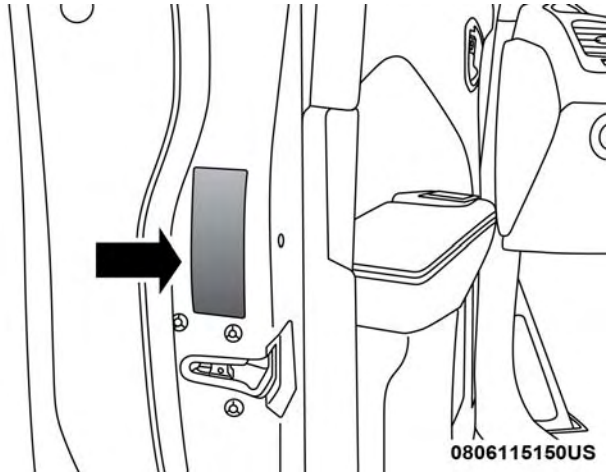

Example Tire Placard Location (Door)

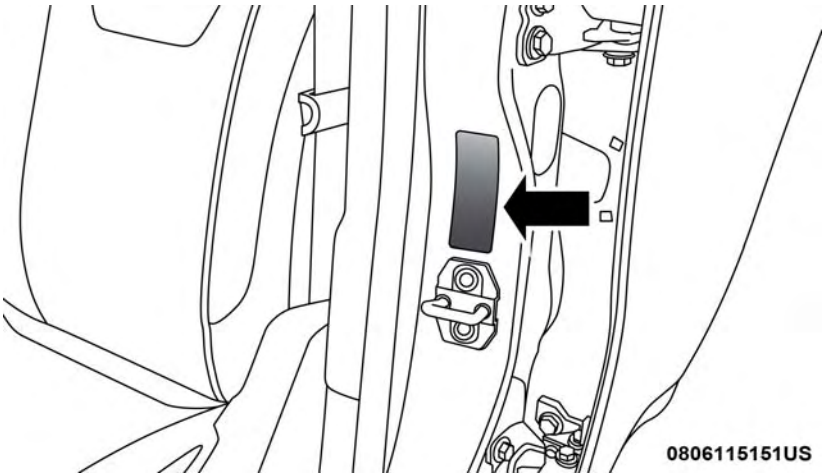

Example Tire Placard Location (B-Pillar)

Tire And Loading Information Placard

TIRE AND LOADING INFORMATION

SEATING CAPACITY - TOTAL 5 FRONT 2 REAR 3

THE COMBINED WEIGHT OF OCCUPANTS AND CARGO SHOULD NEVER EXCEED XXX KG OR XXX LBS.

TIRE	FRONT	REAR	SPARE
ORIGINAL TIRE SIZE	P195/70R14	P195/70R14	T125/70D15
COLD TIRE INFLATION PRESSURE	200kPa, 29PSI	200kPa, 29PSI	420kPa, 60PSI

SEE OWNER'S MANUAL FOR ADDITIONAL INFORMATION 4N109268

811b5a9a

Tire And Loading Information Placard

This placard tells you important information about the:

1. Number of people that can be carried in the vehicle.
2. Total weight your vehicle can carry.
3. Tire size designed for your vehicle.
4. Cold tire inflation pressures for the front, rear, and spare tires.

Loading

The vehicle maximum load on the tire must not exceed the load carrying capacity of the tire on your vehicle. You will not exceed the tire's load carrying capacity if you adhere to the loading conditions, tire size, and cold tire inflation pressures specified on the Tire and Loading Information placard in "Vehicle Loading" in the "Starting And Operating" section of this manual.

NOTE: Under a maximum loaded vehicle condition, gross axle weight ratings (GAWRs) for the front and rear axles must not be exceeded.

For further information on GAWRs, vehicle loading, and trailer towing, refer to "Vehicle Loading" in the "Starting And Operating" section of this manual.

To determine the maximum loading conditions of your vehicle, locate the statement "The combined weight of occupants and cargo should never exceed XXX kg or XXX lbs" on the Tire and Loading Information placard.

TIRES

The combined weight of occupants, cargo/luggage and trailer tongue weight (if applicable) should never exceed the weight referenced here.

Steps For Determining Correct Load Limit—

(1) Locate the statement “The combined weight of occupants and cargo should never exceed XXX kg or XXX lbs.” on your vehicle’s placard.

(2) Determine the combined weight of the driver and passengers that will be riding in your vehicle.

(3) Subtract the combined weight of the driver and passengers from XXX kg or XXX lbs.

(4) The resulting figure equals the available amount of cargo and luggage load capacity. For example, if “XXX” amount equals 1400 lbs. and there will be five 150 lb passengers in your vehicle, the amount of available cargo and luggage load capacity is 650 lbs. ($1400 - 750 = 650$ lbs.)

(5) Determine the combined weight of luggage and cargo being loaded on the vehicle. That weight may not safely exceed the available cargo and luggage load capacity calculated in Step 4.

(6) If your vehicle will be towing a trailer, load from your trailer will be transferred to your vehicle. Consult this manual to determine how this reduces the available cargo and luggage load capacity of your vehicle.

Metric Example For Load Limit

For example, if “XXX” amount equals 635 kg and there will be five 68 kg passengers in your vehicle, the amount of available cargo and luggage load capacity is 295 kg ($635 - 340 = 295$ kg) as shown in step 4.

NOTE:

- If your vehicle will be towing a trailer, load from your trailer will be transferred to your vehicle. The following table shows examples on how to calculate total load, cargo/luggage, and towing capacities of your vehicle with varying seating configurations and number and size of occupants. This table is for illustration purposes only and may not be accurate for the seating and load carry capacity of your vehicle.
- For the following example, the combined weight of occupants and cargo should never exceed 865 lbs (392 kg).

Occupants		Combined weight of occupants and cargo from Tire Placard	MINUS	Combined Occupant's weight	=	AVAILABLE Cargo/Luggage and Trailer Tongue Weight
TOTAL	FRONT REAR					
EXAMPLE 1						
5	2 3	865 lbs	minus	670 lbs	=	195 lbs
Occupant 1: 200 lbs Occupant 2: 160 lbs Occupant 3: 160 lbs Occupant 4: 100 lbs Occupant 5: 80 lbs TOTAL WEIGHT: 670 lbs						
EXAMPLE 2						
3	2 1	865 lbs	minus	540 lbs	=	325 lbs
Occupant 1: 210 lbs Occupant 2: 180 lbs Occupant 3: 150 lbs TOTAL WEIGHT: 540 lbs						
EXAMPLE 3						
2	2 0	865 lbs	minus	400 lbs	=	465 lbs
Occupant 1: 200 lbs Occupant 2: 200 lbs TOTAL WEIGHT: 400 lbs						

811e4d11

WARNING!

Overloading of your tires is dangerous. Overloading can cause tire failure, affect vehicle handling, and increase your stopping distance. Use tires of the recommended load capacity for your vehicle. Never overload them.

TIRES

Tires — General Information

Tire Pressure

Proper tire inflation pressure is essential to the safe and satisfactory operation of your vehicle. Four primary areas are affected by improper tire pressure:

- Safety and Vehicle Stability
- Economy
- Tread Wear
- Ride Comfort

Safety

WARNING!

- **Improperly inflated tires are dangerous and can cause collisions.**
- **Underinflation increases tire flexing and can result in overheating and tire failure.**
- **Overinflation reduces a tire's ability to cushion shock. Objects on the road and chuckholes can cause damage that result in tire failure.**
- **Overinflated or underinflated tires can affect vehicle handling and can fail suddenly, resulting in loss of vehicle control.**
- **Unequal tire pressures can cause steering problems. You could lose control of your vehicle.**
- **Unequal tire pressures from one side of the vehicle to the other can cause the vehicle to drift to the right or left.**
- **Always drive with each tire inflated to the recommended cold tire inflation pressure.**

Both under-inflation and over-inflation affect the stability of the vehicle and can produce a feeling of sluggish response or over responsiveness in the steering.

NOTE:

- Unequal tire pressures from side to side may cause erratic and unpredictable steering response.
- Unequal tire pressure from side to side may cause the vehicle to drift left or right.

Fuel Economy

Underinflated tires will increase tire rolling resistance resulting in higher fuel consumption.

Tread Wear

Improper cold tire inflation pressures can cause abnormal wear patterns and reduced tread life, resulting in the need for earlier tire replacement.

Ride Comfort And Vehicle Stability

Proper tire inflation contributes to a comfortable ride. Over-inflation produces a jarring and uncomfortable ride.

Tire Inflation Pressures

The proper cold tire inflation pressure is listed on the driver's side B-Pillar or rear edge of the driver's side door.

At least once a month:

- Check and adjust tire pressure with a good quality pocket-type pressure gauge. Do not make a visual judgement when determining proper inflation. Tires may look properly inflated even when they are under-inflated.
- Inspect tires for signs of tire wear or visible damage.

CAUTION!

After inspecting or adjusting the tire pressure, always reinstall the valve stem cap. This will prevent moisture and dirt from entering the valve stem, which could damage the valve stem.

Inflation pressures specified on the placard are always "cold tire inflation pressure". Cold tire inflation pressure is defined as the tire pressure after the vehicle has not been driven for at least three hours, or driven less than 1 mile (1.6 km) after sitting for a minimum of three hours. The cold tire inflation pressure must not exceed the maximum inflation pressure molded into the tire sidewall.

Check tire pressures more often if subject to a wide range of outdoor temperatures, as tire pressures vary with temperature changes.

Tire pressures change by approximately 1 psi (7 kPa) per 12°F (7°C) of air temperature change. Keep this in mind when checking tire pressure inside a garage, especially in the Winter.

TIRES

Example: If garage temperature = 68°F (20°C) and the outside temperature = 32°F (0°C) then the cold tire inflation pressure should be increased by 3 psi (21 kPa), which equals 1 psi (7 kPa) for every 12°F (7°C) for this outside temperature condition.

Tire pressure may increase from 2 to 6 psi (13 to 40 kPa) during operation. DO NOT reduce this normal pressure build up or your tire pressure will be too low.

Tire Pressures For High Speed Operation

The manufacturer advocates driving at safe speeds and within posted speed limits. Where speed limits or conditions are such that the vehicle can be driven at high speeds, maintaining correct tire inflation pressure is very important. Increased tire pressure and reduced vehicle loading may be required for high-speed vehicle operation. Refer to your authorized tire dealer or original equipment vehicle dealer for recommended safe operating speeds, loading and cold tire inflation pressures.

WARNING!

High speed driving with your vehicle under maximum load is dangerous. The added strain on your tires could cause them to fail. You could have a serious collision. Do not drive a vehicle loaded to the maximum capacity at continuous speeds above 75 mph (120 km/h).

Radial Ply Tires

WARNING!

Combining radial ply tires with other types of tires on your vehicle will cause your vehicle to handle poorly. The instability could cause a collision. Always use radial ply tires in sets of four. Never combine them with other types of tires.

Tire Repair

If your tire becomes damaged, it may be repaired if it meets the following criteria:

- The tire has not been driven on when flat.
- The damage is only on the tread section of your tire (sidewall damage is not repairable).
- The puncture is no greater than a $\frac{1}{4}$ of an inch (6 mm).

Consult an authorized tire dealer for tire repairs and additional information.

Damaged Run Flat tires, or Run Flat tires that have experienced a loss of pressure should be replaced immediately with another Run Flat tire of identical size and service description (Load Index and Speed Symbol).

Run Flat Tires — If Equipped

Run Flat tires allow you the capability to drive 50 miles (80 km) at 50 mph (80 km/h) after a rapid loss of inflation pressure. This rapid loss of inflation is referred to as the Run Flat mode. A Run Flat mode occurs when the tire inflation pressure is of/or below 14 psi (96 kPa). Once a Run Flat tire reaches the run flat mode it has limited driving capabilities and needs to be replaced immediately. A Run Flat tire is not repairable.

It is not recommended driving a vehicle loaded at full capacity or to tow a trailer while a tire is in the run flat mode.

See the tire pressure monitoring section for more information.

Tire Spinning

When stuck in mud, sand, snow, or ice conditions, do not spin your vehicle's wheels above 30 mph (48 km/h) or for longer than 30 seconds continuously without stopping.

Refer to "Freeing A Stuck Vehicle" in "In Case Of Emergency" for further information.

TIRES

WARNING!

Fast spinning tires can be dangerous. Forces generated by excessive wheel speeds may cause tire damage or failure. A tire could explode and injure someone. Do not spin your vehicle's wheels faster than 30 mph (48 km/h) for more than 30 seconds continuously when you are stuck, and do not let anyone near a spinning wheel, no matter what the speed.

Tread Wear Indicators

Tread wear indicators are in the original equipment tires to help you in determining when your tires should be replaced.

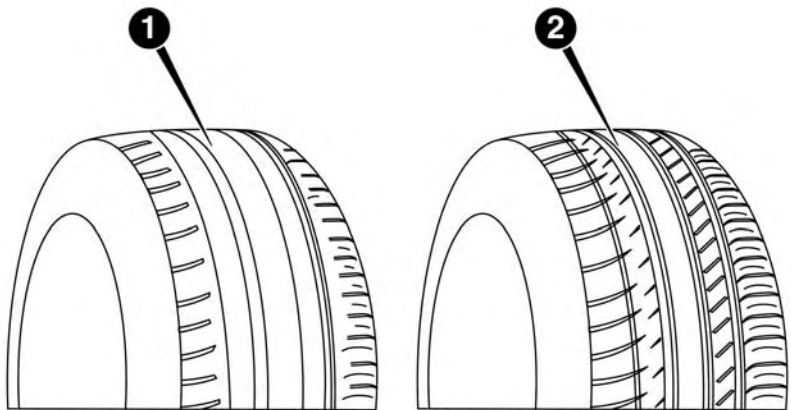

0806104865NA

Tire Tread

- 1 — Worn Tire
- 2 — New Tire

These indicators are molded into the bottom of the tread grooves. They will appear as bands when the tread depth becomes a 1/16 of an inch (1.6 mm). When the tread is worn to the tread wear indicators, the tire should be replaced. Refer to "Replacement Tires" in this section for further information.

Life Of Tire

The service life of a tire is dependent upon varying factors including, but not limited to:

- Driving style.
- Tire pressure - Improper cold tire inflation pressures can cause uneven wear patterns to develop across the tire tread. These abnormal wear patterns will reduce tread life, resulting in the need for earlier tire replacement.
- Distance driven.
- Performance tires, tires with a speed rating of V or higher, and Summer tires typically have a reduced tread life. Rotation of these tires per the vehicle scheduled maintenance is highly recommended.

WARNING!

Tires and the spare tire should be replaced after six years, regardless of the remaining tread. Failure to follow this warning can result in sudden tire failure. You could lose control and have a collision resulting in serious injury or death.

Keep dismantled tires in a cool, dry place with as little exposure to light as possible. Protect tires from contact with oil, grease, and gasoline.

Replacement Tires

The tires on your new vehicle provide a balance of many characteristics. They should be inspected regularly for wear and correct cold tire inflation pressures. The manufacturer strongly recommends that you use tires equivalent to the originals in size, quality and performance when replacement is needed. Refer to the paragraph on “Tread Wear Indicators” in this section. Refer to the Tire and Loading Information placard or the Vehicle Certification Label for the size designation of your tire. The Load Index and Speed Symbol for your tire will be found on the original equipment tire sidewall.

See the Tire Sizing Chart example found in the “Tire Safety Information” section of this manual for more information relating to the Load Index and Speed Symbol of a tire.

It is recommended to replace the two front tires or two rear tires as a pair. Replacing just one tire can seriously affect your vehicle’s handling. If you

TIRES

ever replace a wheel, make sure that the wheel's specifications match those of the original wheels.

It is recommended you contact your authorized tire dealer or original equipment dealer with any questions you may have on tire specifications or capability. Failure to use equivalent replacement tires may adversely affect the safety, handling, and ride of your vehicle.

WARNING!

- **Do not use a tire, wheel size, load rating, or speed rating other than that specified for your vehicle. Some combinations of unapproved tires and wheels may change suspension dimensions and performance characteristics, resulting in changes to steering, handling, and braking of your vehicle. This can cause unpredictable handling and stress to steering and suspension components. You could lose control and have a collision resulting in serious injury or death. Use only the tire and wheel sizes with load ratings approved for your vehicle.**
- **Never use a tire with a smaller load index or capacity, other than what was originally equipped on your vehicle. Using a tire with a smaller load index could result in tire overloading and failure. You could lose control and have a collision.**
- **Failure to equip your vehicle with tires having adequate speed capability can result in sudden tire failure and loss of vehicle control.**

CAUTION!

Replacing original tires with tires of a different size may result in false speedometer and odometer readings.

Tire Types

All Season Tires — If Equipped

All Season tires provide traction for all seasons (Spring, Summer, Fall, and Winter). Traction levels may vary between different all season tires. All season tires can be identified by the M+S, M&S, M/S or MS designation on the tire sidewall. Use all season tires only in sets of four; failure to do so may adversely affect the safety and handling of your vehicle.

Summer Or Three Season Tires — If Equipped

Summer tires provide traction in both wet and dry conditions, and are not intended to be driven in snow or on ice. If your vehicle is equipped with Summer tires, be aware these tires are not designed for Winter or cold driving conditions. Install Winter tires on your vehicle when ambient temperatures are less than 40°F (5°C) or if roads are covered with ice or snow. For more information, contact an authorized dealer.

Summer tires do not contain the all season designation or mountain/snowflake symbol on the tire sidewall. Use Summer tires only in sets of four; failure to do so may adversely affect the safety and handling of your vehicle.

WARNING!

Do not use Summer tires in snow/ice conditions. You could lose vehicle control, resulting in severe injury or death. Driving too fast for conditions also creates the possibility of loss of vehicle control.

Snow Tires

Some areas of the country require the use of snow tires during the Winter. Snow tires can be identified by a “mountain/snowflake” symbol on the tire sidewall.



If you need snow tires, select tires equivalent in size and type to the original equipment tires. Use snow tires only in sets of four; failure to do so may adversely affect the safety and handling of your vehicle.

Snow tires generally have lower speed ratings than what was originally equipped with your vehicle and should not be operated at sustained speeds over 75 mph (120 km/h). For speeds above 75 mph (120 km/h) refer to original equipment or an authorized tire dealer for recommended safe operating speeds, loading and cold tire inflation pressures.

While studded tires improve performance on ice, skid and traction capability on wet or dry surfaces may be poorer than that of non-studded tires. Some states prohibit studded tires; therefore, local laws should be checked before using these tire types.

TIRES

Spare Tires — If Equipped

NOTE: For vehicles equipped with Tire Service Kit instead of a spare tire, please refer to “Tire Service Kit” in “In Case Of Emergency” for further information.

CAUTION!

Because of the reduced ground clearance, do not take your vehicle through an automatic car wash with a compact or limited use temporary spare installed. Damage to the vehicle may result.

Spare Tire Matching Original Equipped Tire And Wheel — If Equipped

Your vehicle may be equipped with a spare tire and wheel equivalent in look and function to the original equipment tire and wheel found on the front or rear axle of your vehicle. This spare tire may be used in the tire rotation for your vehicle. If your vehicle has this option, refer to an authorized tire dealer for the recommended tire rotation pattern.

Compact Spare Tire — If Equipped

The compact spare is for temporary emergency use only. You can identify if your vehicle is equipped with a compact spare by looking at the spare tire description on the Tire and Loading Information Placard located on the driver’s side door opening or on the sidewall of the tire. Compact spare tire descriptions begin with the letter “T” or “S” preceding the size designation. Example: T145/80D18 103M.

T, S = Temporary Spare Tire

Since this tire has limited tread life, the original equipment tire should be repaired (or replaced) and reinstalled on your vehicle at the first opportunity.

Do not install a wheel cover or attempt to mount a conventional tire on the compact spare wheel, since the wheel is designed specifically for the compact spare tire. Do not install more than one compact spare tire and wheel on the vehicle at any given time.

WARNING!

Compact and collapsible spares are for temporary emergency use only. With these spares, do not drive more than 50 mph (80 km/h). Temporary use spares have limited tread life. When the tread is worn to the tread wear indicators, the temporary use spare tire needs to be replaced. Be sure to follow the warnings, which apply to your spare. Failure to do so could result in spare tire failure and loss of vehicle control.

Collapsible Spare Tire — If Equipped

The collapsible spare is for temporary emergency use only. You can identify if your vehicle is equipped with a collapsible spare by looking at the spare tire description on the Tire and Loading Information Placard located on the driver's side door opening or on the sidewall of the tire.

Collapsible spare tire description example: 165/80-17 101P.

Since this tire has limited tread life, the original equipment tire should be repaired (or replaced) and reinstalled on your vehicle at the first opportunity.

Inflate collapsible tire only after the wheel is properly installed to the vehicle. Inflate the collapsible tire using the electric air pump before lowering the vehicle.

Do not install a wheel cover or attempt to mount a conventional tire on the collapsible spare wheel, since the wheel is designed specifically for the collapsible spare tire.

WARNING!

Compact and Collapsible spares are for temporary emergency use only. With these spares, do not drive more than 50 mph (80 km/h). Temporary use spares have limited tread life. When the tread is worn to the tread wear indicators, the temporary use spare tire needs to be replaced. Be sure to follow the warnings, which apply to your spare. Failure to do so could result in spare tire failure and loss of vehicle control.

TIRES

Full Size Spare — If Equipped

The full size spare is for temporary emergency use only. This tire may look like the originally equipped tire on the front or rear axle of your vehicle, but it is not. This spare tire may have limited tread life. When the tread is worn to the tread wear indicators, the temporary use full size spare tire needs to be replaced. Since it is not the same as your original equipment tire, replace (or repair) the original equipment tire and reinstall on the vehicle at the first opportunity.

Limited Use Spare — If Equipped

The limited use spare tire is for temporary emergency use only. This tire is identified by a label located on the limited use spare wheel. This label contains the driving limitations for this spare. This tire may look like the original equipped tire on the front or rear axle of your vehicle, but it is not. Installation of this limited use spare tire affects vehicle handling. Since it is not the same as your original equipment tire, replace (or repair) the original equipment tire and reinstall on the vehicle at the first opportunity.

WARNING!

Limited use spares are for emergency use only. Installation of this limited use spare tire affects vehicle handling. With this tire, do not drive more than the speed listed on the limited use spare wheel. Keep inflated to the cold tire inflation pressures listed on your Tire and Loading Information Placard located on the driver's side B-Pillar or the rear edge of the driver's side door. Replace (or repair) the original equipment tire at the first opportunity and reinstall it on your vehicle. Failure to do so could result in loss of vehicle control.

DEPARTMENT OF TRANSPORTATION UNIFORM TIRE QUALITY GRADES

The following tire grading categories were established by the National Highway Traffic Safety Administration. The specific grade rating assigned by the tire's manufacturer in each category is shown on the sidewall of the tires on your vehicle.

All passenger vehicle tires must conform to Federal safety requirements in addition to these grades.

Treadwear

The Treadwear grade is a comparative rating, based on the wear rate of the tire when tested under controlled conditions on a specified government test course. For example, a tire graded 150 would wear one and one-half times as well on the government course as a tire graded 100. The relative performance of tires depends upon the actual conditions of their use, however, and may depart significantly from the norm due to variations in driving habits, service practices, and differences in road characteristics and climate.

Traction Grades

The Traction grades, from highest to lowest, are AA, A, B, and C. These grades represent the tire's ability to stop on wet pavement, as measured under controlled conditions on specified government test surfaces of asphalt and concrete. A tire marked C may have poor traction performance.

WARNING!

The traction grade assigned to this tire is based on straight-ahead braking traction tests, and does not include acceleration, cornering, hydroplaning, or peak traction characteristics.

Temperature Grades

The Temperature grades are A (the highest), B, and C, representing the tire's resistance to the generation of heat and its ability to dissipate heat, when tested under controlled conditions on a specified indoor laboratory test wheel.

Sustained high temperature can cause the material of the tire to degenerate and reduce tire life, and excessive temperature can lead to sudden tire failure. The grade C corresponds to a level of performance, which all passenger vehicle tires must meet under the Federal Motor Vehicle Safety Standard No. 109. Grades B and A represent higher levels of performance on the laboratory test wheel, than the minimum required by law.

WARNING!

The temperature grade for this tire is established for a tire that is properly inflated and not overloaded. Excessive speed, under-inflation, or excessive loading, either separately or in combination, can cause heat buildup and possible tire failure.

TIRE WARRANTY

Tire Limited Warranty And Adjustment Policy

When a tire is removed from service due to a covered warranty condition under a tire manufacturer's "Limited Warranty Program", you may be eligible for a free tire replacement or a comparable new tire on a "prorated basis".

Certain conditions, such as irregular wear or tire damage due to road hazards, collision, improper inflation, intentional alteration, and misuse, are excluded from the Limited Warranty Program. The Limited Warranty Program expires when your tires either wear to a specified tread depth, and/or after a period of time from the date of purchase, as stated in the Tire Warranty on the DVD.

NOTE: Refer to the Tire Warranty on the DVD for specific information relating to the tire manufacturer's limited warranty for the tires installed on your vehicle. If you have any questions regarding the limited tire warranty coverage, contact your local authorized dealer or your local authorized tire dealer.

Disclaimer:

THE TIRE MANUFACTURER'S LIMITED WARRANTY PROGRAM, THE DETAILS OF WHICH CAN BE FOUND ON THE OWNERS MANUAL DVD, THE TIRE MANUFACTURER'S WEBSITE OR AT ANY AUTHORIZED SERVICE CENTER ARE IN LIEU OF ALL OTHER REMEDIES OR WARRANTIES, EXPRESS OR IMPLIED, ARISING BY LAW OR OTHERWISE, INCLUDING FITNESS FOR A PARTICULAR PURPOSE OR MERCHANTABILITY. THE TIRE MANUFACTURER EXPRESSLY DISCLAIMS LIABILITY FOR INDIRECT, SPECIAL, INCIDENTAL OR CONSEQUENTIAL DAMAGES, LOST PROFIT, LOSS OF BUSINESS, LOSS OF GOODWILL, LOSS OF REPUTATION, PUNITIVE OR ANY OTHER DAMAGE, COST OR LOSS OF ANY KIND. SOME STATES AND PROVINCES DO NOT ALLOW THE EXCLUSION OR LIMITATION OF INCIDENTAL OR CONSEQUENTIAL DAMAGES, SO THE ABOVE LIMITATION OR EXCLUSION MAY NOT APPLY TO YOU.

WARNING!

Refer to the Owner's Manual on the DVD for complete warning information that could prevent accidents, injuries and even deaths.

WARNING!

Death, serious injury and/or property damage may result from tire failure due to tire damage and/or improper tire maintenance.

- All tires (including spare) should be inspected regularly by a qualified technician for signs of wear, and signs of damage, such as puncture, impact, improper maintenance, under-inflation or over-inflation and overloading.
- Only qualified persons should repair tires. See Rubber Manufacturer's Association (RMA) established repair procedures at www.rma.org for information on proper repair procedures.
- Only specially trained persons should mount tires.

Check Your Tires For Damage

Frequent (at least monthly) inspection of your tires for signs of damage, uneven tread wear and their general condition is important for safety. Impacts, penetrations, cracks, knots, bulges or air loss always require tire removal and expert inspection.

NOTE: All tire warranties are made by the tire manufacturer. Tires are not covered under your New Vehicle Limited Warranty.

BFGOODRICH TIRES

ABOUT THIS WARRANTY

As the original purchaser of a BFGoodrich brand passenger or light truck tire, you are covered by all the benefits and conditions (subject to the maintenance recommendations and safety warnings) contained in this booklet. To ensure your understanding of and compliance with the terms and conditions of this warranty, please read it carefully. It is essential that you also read and understand the safety and maintenance recommendations for tires contained in this booklet.

WHAT IS COVERED AND FOR HOW LONG

Passenger and Light Truck Tires

BFGoodrich brand passenger and light truck tires, used in normal service on the vehicle on which they were originally fitted and in accordance with the maintenance recommendations and safety warnings contained in the attached owner's manual, are covered by this warranty against defects in workmanship and materials for the life of the original usable tread, or 6 years from the date of purchase, whichever occurs first. At that time, all warranties, express or implied, expire. The life of the original usable tread is the original tread down to the level of the tread wear indicators - 2/32 nds of an inch (1.6 mm) of tread remaining. Date of purchase is documented by new vehicle registration or tire sales invoice. If no proof of purchase is available, coverage will be based on the date of manufacture. Replacement will be made in accordance with the terms and conditions described under "How Replacement Charges are Calculated". Note: your vehicle manufacturer may provide additional tire warranty coverage over and above what is provided by BFGoodrich. Consult your vehicle owner's manual for further information.

WHAT IS NOT COVERED

Tires Which Become Unserviceable Due To:

- Road hazard injury (e.g., a cut, snag, bruise, impact damage or puncture);
- Incorrect mounting of the tire, tire/wheel imbalance or improper repair;

BFGOODRICH TIRES

- Misapplication, improper maintenance, racing, underinflation, overinflation or other abuse;
- Operation without a properly functioning low pressure warning system, for Comp T/A® ZR SSS tires;
- Uneven or rapid wear which is caused by mechanical irregularity in the vehicle such as wheel misalignment, (a measured tread difference of 2/32 nds of an inch (1.6 mm) or more across the tread on the same tire);
- Accident, fire, chemical corrosion, tire alteration or vandalism;
- Flat spotting caused by improper storage or brake lock;
- The adding of liquid, solid or gaseous materials other than air, nitrogen or carbon dioxide (for example, waterbase sealers or balancing substances);
- Ozone or weather checking.

HOW REPLACEMENT CHARGES ARE CALCULATED

Passenger And Light Truck Tires Workmanship/Materials

A tire which becomes unserviceable due to a condition covered by this workmanship and materials limited warranty will be replaced with a comparable new BFGoodrich brand tire, free of charge, when 2/32 nds of an inch (1.6 mm) or less of the original tread is worn, (or 25% or less, whichever is more beneficial to you) and within 12 months of the date of purchase. The cost of mounting and balancing the tire is included. **You pay the cost of any other service charges and applicable taxes.**

When more than 2/32 nds of an inch (1.6 mm) of the original tread has been worn (or more than 25%, whichever is more beneficial to you) or after 12 months from the date of purchase, you must pay the cost of a comparable new BFGoodrich brand passenger or light truck replacement tire on a pro rated basis. The retailer shall determine the charge by multiplying the percentage of the original usable tread worn by the current selling price at the adjustment location or the price on the current BFGoodrich brand Base Price List, whichever is lower. This list is based on a predetermined price intended to fairly represent the actual selling price of the tire.

You pay the cost of mounting, balancing, and or any other service charges and applicable taxes.

WHAT YOU MUST DO WHEN MAKING A CLAIM

When making a claim under the terms of this limited warranty you must present your tire(s), your vehicle, and your original invoice to a participating BFGoodrich brand tire retailer. BFGoodrich brand tire retailers are listed in the yellow pages under "Tire Dealers-Retail". Personal identification (i.e. Driver's License, Credit Card, etc.) and vehicle registration may be required. **You pay any service charges for normal vehicle and tire maintenance.**

CONDITIONS AND EXCLUSIONS

This limited warranty does not provide compensation for loss of time, loss of use of vehicle, inconvenience or incidental or consequential damages.

Tires presented for claim remain the property of the consumer and BFGoodrich brand accepts no responsibility for loss of, or damage to, tires which are in the custody or control of a BFGoodrich tire retailer for the purpose of inspection for warranty adjustment.

In the event of a disputed claim, the consumer must make the tire available for further inspection. Tires accepted for claim become the property of Michelin North America Inc.

No BFGoodrich brand representative, employee or retailer has the authority to make or imply any representation, promise or agreement, which in any way varies from the terms of this limited warranty. This limited warranty applies only in the United States and Canada.

SAFETY MAINTENANCE INFORMATION

Read your Tire Owner's Manual, the information on the sidewall of your tires, your vehicle owner's manual and vehicle tire information placard for essential safety and maintenance information.

When service is required:

1. Contact a participating BFGoodrich tire retailer listed in your yellow pages.
2. If additional assistance is needed in locating a BFGoodrich retailer, please call or write to Consumer Relations as listed on page 43.

You should have complete confidence in your new BFGoodrich tires. Still it's important to register your tires in the event that we need to contact you. For online tire registration, visit www.tireregistration.com.

WARNING!

DISREGARDING ANY OF THE SAFETY PRECAUTIONS AND/OR INSTRUCTIONS CONTAINED IN THIS MANUAL MAY RESULT IN TIRE FAILURE OR EXPLOSION CAUSING SERIOUS PERSONAL INJURY OR DEATH.

TIRE DISABLEMENT SAFETY WARNING

Any tire may fail as a result of an improperly repaired puncture, impact damage, improper inflation, overloading or other conditions resulting from use or misuse. Tire failures, such as a rapid air loss or a tread and belt detachment, may increase risk of injury or death and/or property damage. To reduce the risk of a tire failure, BFGoodrich recommends you thoroughly read and follow the recommendations in this BFGoodrich Limited Warranty/Owner's Manual, the vehicle owner's manual, tire placard information, and tire sidewall information regarding safety warnings, proper tire use and maintenance.

CONTROLLABILITY

CONTROLLING A VEHICLE WHEN A TIRE FAILURE OCCURS

If a tire failure occurs, you may hear a loud noise, feel a vibration, and/or the vehicle may pull toward the side of the failed tire. If possible, step on the accelerator momentarily to maintain forward momentum and ensure vehicle control.

It is important that you DO NOT BRAKE OR ABRUPTLY TURN THE STEERING WHEEL.

Slowly remove your foot from the accelerator and hold the steering wheel firmly while steering to remain in your lane. Once the vehicle has slowed and is fully under control, apply the brakes gently; safely pull over to the shoulder and come to a stop. Inspect the tires. If one or more tires look flat or low, show detachment or other damage, remove tire assembly and replace it with a properly inflated spare. Bumps or bulges may indicate detachment within the tire body and require inspection by a qualified tire technician.

DRIVING ON ANY TIRE THAT DOES NOT HAVE THE CORRECT INFLATION PRESSURE IS DANGEROUS

Any underinflated tire builds up excessive heat that may result in sudden tire destruction. If tires are supplied as original equipment, refer to the tire decal on the vehicle (check vehicle and/or vehicle owner's manual for decal location) for the recommended operating pressures. For replacement tires, the correct inflation pressure will be provided by your tire retailer; if not, refer to the vehicle decal.

These inflation pressures must be maintained as a minimum. However, do not exceed the maximum pressure rating indicated on the tire sidewall.

CHECK THE COLD INFLATION PRESSURES IN ALL YOUR TIRES, INCLUDING THE SPARE, AT LEAST ONCE EACH MONTH

Failure to maintain correct inflation may result in improper vehicle handling and may cause rapid and irregular tire wear, sudden tire destruction, loss of vehicle control and serious personal injury. Therefore, inflation pressures should be checked at least once each month and always prior to long distance trips. This applies to all tires, including sealant types, and Self-Supporting tires which are as susceptible to losing air pressure as any other type of tire if not properly maintained.

UNDERINFLATION

It is impossible to determine whether tires are properly inflated by simply looking at them. It is almost impossible to "feel or hear" when a tire is being run underinflated or nearly flat. Tires must be checked monthly with a tire pressure gauge.

Pressures should be checked when tires are cold, in other words, before they have been driven on. Driving, even for a short distance, causes tires to heat up and air pressure to increase.

Checking pressure when tires are hot:

If pressures are checked after tires have been driven for more than three minutes or more than one mile, (1.6 km) the tires become hot and the pressures will increase by approximately 4 psi. Therefore when the tire pressure is adjusted under these conditions, it should be increased to a gauge reading of 4 psi greater than the recommended cold inflation pressure.

BFGOODRICH TIRES

For Example Only:

Gauge reading of hot tire:	32 psi (220 kPa)
If recommended cold inflation pressure is:	30 psi (205 kPa)
Desired gauge reading of hot tire 30 + 4 psi =	34 psi (205 + 30 = 235 kPa)
Therefore: add 2 psi	(15 kPa)

Check cold pressure as soon as possible, preferably within 24 hours. "Bleeding" air from hot tires could result in under-inflation. Use an accurate tire gauge to check pressures. Never allow children to inflate or deflate tires.

TIRE PRESSURE MONITORING SYSTEMS (TPMS):

Your vehicle may be equipped with a Tire Pressure Monitoring System (TPMS) that is designed to monitor the pressure of tires mounted on your vehicle and sends a signal to the driver if a tire pressure falls below a predetermined level. A TPMS should not replace monthly manual pressure checks for all four (4) tires and the spare. We recommend that you manually monitor and check tire pressure inflation with a pressure gauge.

Your tires should have the recommended pressure listed by your vehicle's manufacturer. This information can be found in the vehicle owner's manual and often on a placard located in the vehicle's door jamb, inside the fuel hatch, or on the glove compartment door. If you have a plus size fitment that requires a higher inflation pressure, your tire pressure monitoring system will require re-calibration to the new inflation pressure. Refer to your tire dealer/installer of plus size tires for proper inflation pressure.

We recommend checking air pressure once each month, and before a long trip. Whether you have a full-sized or mini-spare, make sure that it is properly inflated as well. If the TPMS generates improper monitoring or signals we recommend that you consult your owner's manual provided with your vehicle and follow-up with your vehicle's manufacturer.

TIRE SPINNING

Do not spin wheels in excess of 35 mph (55 km/h) as indicated on the speedometer. Excessive speed in a free-running, unloaded tire can cause it to “explode” from centrifugal force. The energy released by such an explosion is sufficient to cause serious physical injury or death. Never allow anyone to stand near or behind the spinning tire.

When in mud, sand, snow, ice or other slippery conditions, do not engage in excessive wheel spin. Accelerating the motor excessively, particularly with automatic transmission vehicles, may cause a drive tire that has lost traction to spin beyond its speed capability. This is also true when balancing a drive tire/wheel assembly on the vehicle using the vehicle engine to spin the tire/wheel assembly.

HIGH SPEED DRIVING CAN BE DANGEROUS

Correct inflation pressure is especially important. However, at high speeds, even with the correct inflation pressure, a road hazard, for example is more difficult to avoid and if contact is made, has a greater chance of causing tire damage than at a lower speed. Moreover, driving at high speed reduces the reaction time available to avoid accidents and bring your vehicle to a safe stop.

If you see any damage to a tire or wheel, replace it with the spare at once and visit a participating BFGoodrich Tire Retailer.

Exceeding the maximum speeds shown on the following page for each type of BFGoodrich tire will cause the tire to build up excessive heat which can cause tire damage that could result in sudden tire destruction and rapid air loss. Failure to control a vehicle when one or more tires experience a sudden air loss can lead to an accident.

In any case, you should not exceed reasonable speeds as indicated by the legal limits and driving conditions.

SPEED RATINGS

Speed Symbols are shown on the sidewall of some BFGoodrich tires. The following table shows the maximum speed corresponding to the symbol.

*Some V (or VR) rated tires may have a speed capacity greater than 149 mph (240 km/h). Consult your participating BFGoodrich® tire retailer for maximum speed rating if your vehicle capability exceeds this speed.

**Z (or ZR) rated tires are designed to use on cars with maximum speed capabilities in excess of 149 mph (240 km/h).

(W and Y speed ratings are sub-categories of Z).

Consult your BFGoodrich tire retailer for maximum speed capabilities.

Although a tire may be speed-rated, we do not endorse the operation of any vehicle in an unsafe or unlawful manner. Speed ratings are based on laboratory tests which relate to performance on the road, but are not applicable if tires are underinflated, overloaded, worn out, damaged, altered, improperly repaired, or retreaded. Furthermore, a tire's speed rating does not imply that vehicles can be safely driven at the maximum speed for which the tire is rated, particularly under adverse road and weather conditions or if the vehicle has unusual characteristics.

BFGoodrich highway passenger tires that do not have a speed symbol on the sidewall have a maximum speed rating of 105 mph (170 kph). Light truck highway tires that do not have a speed symbol on the sidewall of the tire have a maximum speed rating of 87 mph (140 kph).

The speed and other ratings of retreaded tires are assigned by the retreader and replace the original manufacturer's ratings.

NOTE: In order to maintain the speed capability of the vehicle, replacement tires must have speed ratings equal to or higher than those fitted as original equipment (as indicated on the vehicle tire placard or owner's manual). If tires with lower speed ratings are fitted, the vehicle's handling may be affected and the speed capability of the vehicle will be lowered to the maximum speed capability of the replacement tires as indicated in the following table.

SPEED Ratings	Maximum Speed		
	Km/hr	mph	
M	130	81	
N	140	87	
P	150	93	
Q	160	100	
R	170	106	
S	180	112	
T	190	118	
H	210	130	
V	240	149	
V*	240+	149+	
W	270	168	ZR** ↓
Y	300	186	
	300+	186+	

REMEMBER.... High speed driving can be dangerous and may damage your tires. **AND....** When driving at highway speeds, correct inflation pressure is especially important.

INSPECT YOUR TIRES, DO NOT DRIVE ON A DAMAGED TIRE OR WHEEL

HAZARDS

Objects in the road, such as potholes, glass, metal, rocks, wood, debris and the like, can damage a tire and should be safely avoided. Unavoidable contact with such objects should prompt a thorough tire inspection.

BFGOODRICH TIRES

Anytime you see any damage to your tires or wheels, replace with the spare at once and immediately visit any BFGoodrich® tire retailer.

IMPACT DAMAGE

A tire impacted by a road hazard (curb, pothole, debris) may be damaged but not have visible signs of damage on its surface. A tire damaged by an impact may sustain a sudden failure a day, week, or even months later. You may not recall hitting an object that damaged or injured your tires. Air loss, unusual tire wear, localized wear or vibrations can also be signs of internal tire damage.

If you suspect any damage to your tire or wheel from an impact with a curb, pothole, debris on the road or any other road hazard, or if you feel or hear any unusual vibration, replace with a properly inflated spare at once and immediately visit any qualified tire technician.

INSPECTION

When inspecting your tires, including the spare, check the air pressures. If the pressure check indicates that one of your tires has lost pressure of two pounds or more, look for signs of penetration, valve leakage or wheel damage that may account for the air loss.

Always look for bulges, cracks, cuts, penetrations and abnormal tire wear, particularly on the edges of the tire tread, which may be caused by misalignment or underinflation. If any such

All tires will wear out faster when subjected to high speeds as well as hard cornering, rapid starts, sudden stops, frequent driving on roads which are in poor condition, and off road use. Roads with holes and rocks or other objects can damage tires and cause misalignment of your vehicle. When driving on such roads, drive carefully and slowly, and before driving again at normal or highway speeds, examine your tires for any damage, such as cuts, bulges, penetrations, unusual wear patterns, etc.

WEAR BARS

BFGoodrich® tires contain “Wear-Bars” in the grooves of the tire tread which show up when only 2/32 nds of an inch (1.6 mm) of tread is remaining. At this stage, your tires must be replaced. Tires worn beyond this stage are extremely dangerous.

DO NOT OVERLOAD - DRIVING ON ANY OVERLOADED TIRE IS DANGEROUS

The maximum load rating of your tires is molded on the tire sidewall. Do not exceed this rating. Follow the loading instructions of the manufacturer of your vehicle and this will ensure that your tires are not overloaded. Tires which are loaded beyond their maximum allowable loads for the particular application will build up excessive heat that may result in sudden tire destruction.

Do not exceed the gross axle weight rating for any axle on your vehicle.

TRAILER TOWING

If you anticipate towing a trailer, you should visit any BFGoodrich® tire retailer for advice concerning the correct size tire and pressures. Tire size and pressures will depend upon the type and size of trailer and hitch utilized, but in no case must the maximum cold inflation pressure or tire load rating be exceeded. Check the tire decal and the owner's manual supplied by the manufacturer of your vehicle for further recommendations on trailer towing.

WHEEL ALIGNMENT AND BALANCING ARE IMPORTANT FOR SAFETY AND MAXIMUM MILEAGE FROM YOUR TIRES CHECK HOW YOUR TIRES ARE WEARING AT LEAST ONCE EACH MONTH

If your tires are wearing unevenly, such as the inside shoulder of the tire wearing faster than the rest of the tread, or if you detect excessive vibration, your vehicle may be out of alignment or balance. These conditions not only shorten the life of your tires but adversely affect the handling characteristics of your vehicle, which could be dangerous. If you detect irregular wear or vibration, have your alignment and balance checked immediately. Tires which have been run underinflated will show more wear on the shoulders than in the center of the tread.

TIRE MIXING

BFGoodrich® tires are radial tires and for best performance it is recommended that the same size and type of tire be used on all four wheel positions. Before mixing tires of different types in any configuration on any vehicle, be sure to check the vehicle manufacturer's Owner's Manual for its recommendations.

It is especially important to check the vehicle manufacturer's owner's manual when mixing, matching or replacing tires on 4-wheel drive vehicles, as this may require special precautions.

BFGOODRICH TIRES

BFGOODRICH® DOES NOT RECOMMEND MIXING SELF SUPPORTING STRUCTURE (SSS) TIRES WITH NON-SSS TIRES OTHER THAN THE TEMPORARY USE OF THE SPARE TIRE.

WINTER DRIVING

Tires which meet the Rubber manufactures Association (RMA) definition of snow tires are marked M/S, M&S. On such tires, this designation is molded into the sidewall. Tires without this notation are not recommended for winter driving.



While All-Season tires are designed to provide reliable performance in some winter conditions, the use of four (4) winter tires is recommended for optimum performance. Tires designated for use in severe winter conditions are marked on at least one sidewall with the letter "M" and "S" plus a pictograph of a mountain with a snowflake on it.

TIRE ROTATION AND REPLACEMENT

To obtain maximum tire wear, it may be necessary to rotate your tires. Refer to your vehicle owner's manual for instructions on tire rotation. If you do not have an owner's manual for your vehicle, BFGoodrich® recommends rotating your tires every 6,000 to 8,000 miles (10,000 to 12,000 km).

Monthly inspection for tire wear is recommended. Your tires should be rotated at the first sign of irregular wear, even if it occurs before 6,000 miles (10,000 km). This is true for all vehicles.

When rotating tires with a directional tread pattern, observe the arrows molded on the sidewall which show the direction the tire should turn. Care must be taken to maintain the proper turning direction.

Some Tire Pressure Monitoring systems (TPMS) may not recognize that a tire has been moved to a different position on your vehicle. Make certain that your TPMS system is reset, if necessary, so as to correctly identify the location of each tire on your vehicle. Refer to your vehicle owner's manual or your vehicle dealer.

Determine whether rotated tires require tire inflation adjustment as front and rear position tire pressure may vary according to the vehicle manufacturer's specification due to the actual load on that wheel position. Some vehicles may have different sized tires mounted on the

front and rear axles, and these different sized tires have rotation restrictions. Always check the vehicle owner's manual for the proper rotation recommendations.

FULL-SIZE SPARE

Full-size spare tires (not temporary spares) of the same size and construction should be used in a five (5) tire rotation. Always check the inflation pressure of the full-size spare immediately before incorporating it into rotation. Follow the vehicle manufacturer's recommended pattern for rotation, or if not available, see a qualified tire technician.

REPLACEMENT OF TWO (2) TIRES

It is recommended that all four (4) tires are replaced at the same time. However, whenever only two tires are replaced, the new ones should be put on the rear. The new tires, with deeper tread, may provide better grip and water evacuation in wet driving conditions.

CUSTOMIZATION OF TIRES, WHEELS, OR SUSPENSION ON SUVs AND LIGHT TRUCKS

Due to their size, weight and higher center of gravity, vehicles such as SUVs and light trucks do not have the same handling characteristics as automobiles. Because of these differing characteristics, failure to operate your SUV/truck in a proper and safe manner can increase the likelihood of vehicle rollover. Modifications to your SUV/truck tire size, tire type, wheels or suspension can change its handling characteristics and further increase the likelihood of vehicle rollover. Whether your SUV/truck has the original equipment configuration for tires, wheels and suspension or whether any of these items have been modified, always drive safely, avoid sudden, sharp turns or lane changes and obey all traffic laws. Failure to do so may result in loss of vehicle control leading to an accident and serious injury or death.

TIRE ALTERATIONS

Do not make or allow to be made any alterations on your tires. Alterations may prevent proper performance, leading to tire damage which can result in an accident. Tires which become unserviceable due to alterations such as trueing, whitewall inlays, addition of balancing or sealant liquids, or the use of tire dressing containing petroleum distillates are excluded from warranty coverage.

BFGOODRICH TIRES

REPAIRS - WHEREVER POSSIBLE, SEE YOUR BFGOODRICH® TIRE RETAILER AT ONCE

If any BFGoodrich® tire sustains a puncture, have the tire demounted and thoroughly inspected by any BFGoodrich® tire retailer for possible damage that may have occurred.

A tread area puncture in any BFGoodrich® passenger or light truck tire can be repaired provided that the puncture hole is not more than 1/4" in diameter, not more than one radial cable per casing ply is damaged, and the tire has not been damaged further by the puncturing object or by running underinflated. Tire punctures consistent with these guidelines can be repaired by following the Rubber Manufacturers Association (RMA) recommended repair procedures.

TIRE REPAIRS

Repairs of all tires must be of the combined plug and inside patch type. **Plug only repairs are improper.** A tire should be removed from the rim and inspected prior to repair. Any tire repair done without removing the tire from the rim is improper. An improperly repaired tire will cause further damage to the tire by either leaking air or allowing air, moisture and contaminants to enter the structure of the tire. An improperly repaired tire can fail suddenly at a later date.

Never repair a tire with less than 2/32 nds of an inch tread remaining. At this tread depth, the tire is worn out and must be replaced.

TEMPORARY SPARE TIRES

When using any temporary spare tire, be sure to follow the vehicle manufacturer's instructions.

READING THE DOT

DOT XXXX XXXX XXX (prior to August 2000)

DOT XXXX XXXX XXX (1990-1999)

DOT XXXX XXXX XXXX (after July 2000)

THE DOT

The "DOT" symbol certifies tire manufacturer's compliance with U.S. Department of Transportation tire safety standards. Next to the symbol is the tire identification or "serial number". The first two characters identify the plant where the tire was manufactured. The next two characters

reflect the tire size. The following one to four digits may be used at the tire manufacturer's option as a descriptive code. The last three characters are numbers identifying the week and year of manufacture. (Example: "O25" means second week of the year of decade, eg.: 1995, 1985, etc.) Tires produced after July 2000 have an additional digit to identify a given decade. For example, 2800 means the tire was produced during the 28th week of 2000; 0201 during the 2nd week of 2001. If the last digits of your DOT number contain three numeric characters consult a qualified tire technician to determine the year and decade of manufacture.

STORAGE

Tires contain waxes and emollients to protect their outer surfaces from ozone and weather checking. As the tire rolls and flexes, the waxes and emollients continually migrate to the surface, replenishing this protection throughout the normal use of the tire. Consequently, when tires sit outdoors, unused for long periods of time (a month or more) their surfaces become dry and more susceptible to ozone and weather checking and the casing becomes susceptible to flat spotting.

For this reason, tires should always be stored in a cool, dry, clean, indoor environment. If storage is for one month or more, eliminate the weight from the tires by raising the vehicle or by removing the tires from the vehicle. Failure to store tires in accordance with these instructions could result in damage to your tires or premature aging of the tires and sudden tire failure.

When tires are stored, be sure they are placed away from sources of heat and ozone such as hot pipes and electric generators. Be sure that surfaces on which tires are stored are clean and free from grease, gasoline or other substances which could deteriorate the rubber. **(Tires exposed to these materials during storage or driving could be subject to sudden failure.)**

FOLLOW THESE MOUNTING RECOMMENDATIONS

Tire changing can be dangerous and must be done by professionally trained persons using proper tools and procedures as specified by the Rubber Manufacturers Association (RMA).

Your tires should be mounted on wheels of correct size and type and which are in good, clean condition. Wheels that are bent, chipped, rusted (steel wheels) or corroded (alloy wheels) may cause tire damage. The inside of the tire must be free from foreign material. Have your retailer check the wheels before mounting new tires. Mismatched tires and rims

BFGOODRICH TIRES

can explode during mounting. Also, mismatched tires and rims can result in dangerous tire failure on the road. If a tire is mounted by error on the wrong-sized rim, do not remount it on the proper rim - scrap it. It may have been damaged internally (which is not externally visible) by having been dangerously stretched and could fail on the highway.

Old valves may leak. When new tubeless tires are mounted, have new valves of the correct type installed. Tubeless tires must only be mounted on wheels designed for tubeless tires i.e., wheels which have safety humps or ledges.

It is recommended that you have your tires and wheels balanced. Tires and wheels which are not balanced may cause steering difficulties, a bumpy ride, and irregular tire wear.

Be sure that all your valves have suitable valve caps. The valve cap is the primary seal against air loss.

SERVICE LIFE FOR PASSENGER CAR AND LIGHT TRUCK TIRES INCLUDING SPARE TIRES

The following recommendation applies to passenger car and light truck tires. Tires are composed of various types of material and rubber compounds, having performance properties essential to the proper functioning of the tire itself. These component properties evolve over time. For each tire, this evolution depends upon many factors such as weather, storage conditions, and conditions of use (load, speed, inflation pressure, maintenance etc.) to which the tire is subjected throughout its life. This service-related evolution varies widely so that accurately predicting the serviceable life of any specific tire in advance is not possible.

That it is why, in addition to regular inspections and inflation pressure maintenance by consumers, it is recommended to have passenger car and light truck tires, including spare tires, inspected regularly by a qualified tire specialist, such as a tire dealer, who will assess the tire's suitability for continued service. Tires which have been in use for 5 years or more should continue to be inspected by a specialist at least annually.

Consumers are strongly encouraged to be aware not only of their tires' visual condition and inflation pressure but also of any change in dynamic performance such as increased air loss, noise or vibration, which could be an indication that the tires need to be removed from service to prevent tire failure.

It is impossible to predict when tires should be replaced based on their calendar age alone. However the older a tire the greater the chance that it will need to be replaced due to the service-related evolution or other conditions found upon inspection or detected during use.

While most tires will need replacement before they achieve 10 years, it is recommended that any tires in service 10 years or more from the date of manufacture, including spare tires, be replaced with new tires as a simple precaution even if such tires appear serviceable and even if they have not reached the legal wear limit.

For tires that were on an original equipment vehicle (i.e., acquired by the consumer on a new vehicle), follow the vehicle manufacturer's tire replacement recommendations, when specified (but not to exceed 10 years).

The date when a tire was manufactured is located on the sidewall of each tire. Consumers should locate the Department of Transportation or DOT code on the tire which begins with DOT and ends with the week and year of manufacture. For example, a DOT code ending with "2204" indicates a tire made in the 22nd week (May) of 2004.

REMEMBER... TO AVOID DAMAGE TO YOUR TIRES AND POSSIBLE ACCIDENT:

- CHECK TIRE PRESSURE AT LEAST ONCE EACH MONTH WHEN TIRES ARE COLD AND BEFORE LONG TRIPS;
- DO NOT UNDERINFLATE/OVERINFLATE;
- DO NOT OVERLOAD;
- DRIVE AT MODERATE SPEEDS, OBSERVE LEGAL LIMITS;
- AVOID DRIVING OVER POTHOLES, OBSTACLES, CURBS OR EDGES OF PAVEMENT;
- AVOID EXCESSIVE WHEEL SPINNING;
- IF YOU SEE ANY DAMAGE TO A TIRE, REPLACE WITH THE SPARE AND VISIT ANY BFGOODRICH® RETAILER AT ONCE;
- IF YOU HAVE ANY QUESTIONS. CONTACT YOUR BFGOODRICH® RETAILER.

FAILURE TO OBSERVE ANY OF THE RECOMMENDED PRECAUTIONS CONTAINED IN THIS OWNER'S MANUAL CAN LEAD TO

BFGOODRICH TIRES

ERRATIC VEHICLE BEHAVIOR AND/OR TIRE DAMAGE, POSSIBLY RESULTING IN AN ACCIDENT.

If you see any damage to your tires or wheels, contact your local participating BFGoodrich® tire retailer listed in the Yellow Pages, or visit our web site listed below for dealer locations. If further assistance is required, contact:

IN USA

877-788-8899

or write:

Michelin North America, Inc.
Attention: Consumer Relations
Department
Post Office Box 19001
Greenville, SC 29602-9001

or visit:

www.bfgoodrichtires.com

IN CANADA

888-871-4444

or write:

Michelin North America (Canada), Inc.
2500 Daniel-Johnson Blvd., Suite 500
Laval, Quebec
H7P 6G2

or visit:

www.bfgoodrichtires.ca

WARNING!

For safety and good performance, you must take care of your tires. Follow the safety information and instructions contained in this Owner's Manual.

Your Vehicle: _____
Year Make/Model

Your Tire Size: _____

Tire Purchase Date: _____

Recommended Pressures: Front _____

Rear _____

Correct tire pressure is very important. Proper inflation pressures may be found in the vehicle owner's manual or on the vehicle tire information placard. Check cold tire pressures at least once each month. For further technical information on BFGoodrich® tires, consult a participating BFGoodrich® tire retailer.

MNA, P.O. BOX 19026, GREENVILLE, SOUTH CAROLINA 29602-9026

AN EQUAL OPPORTUNITY EMPLOYER

BRIDGESTONE® - FIRESTONE®

TIRE MAINTENANCE, SAFETY and WARRANTY MANUAL ORIGINAL EQUIPMENT PASSENGER and LIGHT TRUCK TIRES Including RFT Tires with Run-Flat Technology

Congratulations!

Your new vehicle comes equipped with quality BRIDGESTONE or FIRESTONE brand tires.

To ensure optimum tire performance and reduce the risk of a tire failure, Bridgestone Firestone North American Tire, LLC strongly recommends you read and follow all maintenance and safety information contained in this manual. In addition, we recommend periodic inspection and maintenance, if necessary, by a qualified tire service professional.

Inflate.

Check your tire pressure monthly.

Rotate.

Rotate your tires as recommended by the vehicle manufacturer or every 5,000 miles.

Evaluate.

Routinely look for signs of tread wear or damage.

TIRE CARE BASICS

Quick Reference Guide to Maintenance for All Tires, Including the Spare.

TIRE INFLATION PRESSURE

Tires can lose 1 psi (pound per square inch) per month under normal conditions. Additionally, tires can lose 1 psi for every 10° F temperature drop.

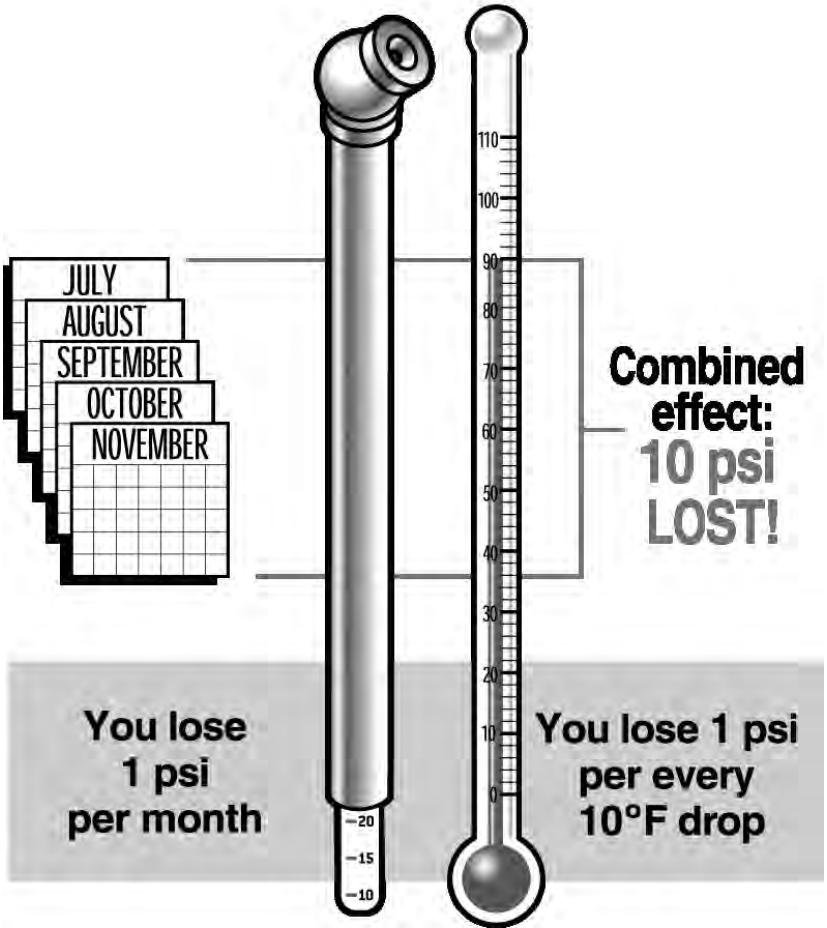

Just a look won't do it. One of these tires is actually 10 psi under-inflated. Your eyes can deceive you, so rely on a good tire gauge for an accurate reading.



30 psi



20 psi

Look for the manufacturer's recommended tire pressure listed on the sticker usually located on the driver's-side door edge or door jamb area. Example:

 TIRE AND LOADING INFORMATION			
SEATING CAPACITY		TOTAL 6	FRONT 3 REAR 3
The combined weight of the occupants and cargo should never exceed 611 kg or 1348 lbs.			
TIRE	SIZE	COLD TIRE PRESSURE	SEE OWNER'S MANUAL FOR ADDITIONAL INFORMATION
FRONT	P245/70R17 108S	240 kPa, 35 PSI	
REAR	P245/70R17 108S	240 kPa, 35 PSI	
SPARE	P245/70R17 108S	240 kPa, 35 PSI	

This chart shows you how underinflation can create an overload on tires. Check your tire pressure every month to make sure it's up to specification, especially before long trips or carrying extra weight.



Based on tire size P235/75R15

These tires are 1230 pounds OVERLOADED!
This is equivalent to *over eight 150 lb. people.*

Lower pressure increases heat. Infrared photography of tires tested at high speed. Damaging heat increases as inflation pressure drops.



Based on tire size P235/75R15

AIR PRESSURE —MONTHLY CHECK

For accuracy, check your inflation pressure with a tire gauge when tires are cold.

Driving heats up tires and makes the reading incorrect.

1. Remove tire valve cap.



2. Place the end of the tire gauge over valve.



3. Press the tire gauge straight and firmly until the scale extends.



4. If needed, increase pressure and recheck with the tire gauge.



5. Replace valve cap.



TIRE ROTATION

For maximum mileage, rotate your tires according to the vehicle manufacturer's recommendations (consult your vehicle owner's manual), or if not provided, rotate every 5,000 miles using a rotation pattern such as below (see "Radial Tire Rotation" in this manual).

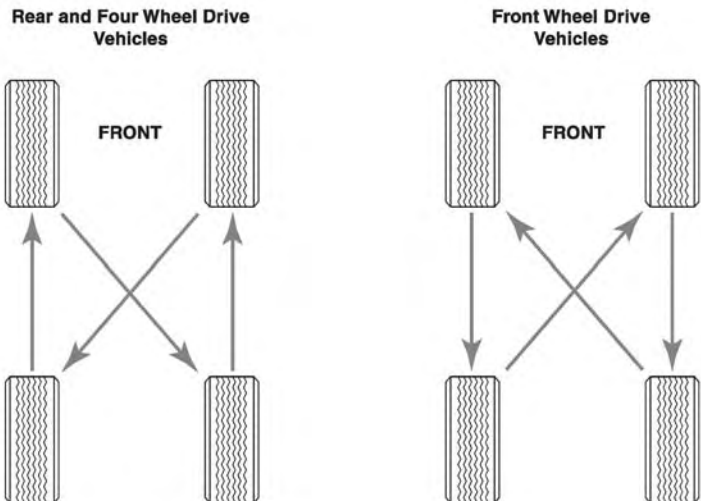

TIRE WEAR—VISUAL CHECK

Check for obvious signs of wear.

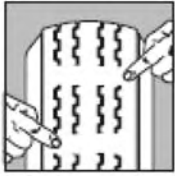

Exposed tread bars (replace)

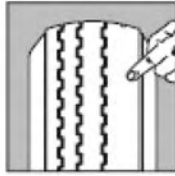

Irregular shoulder wear (have inspected)

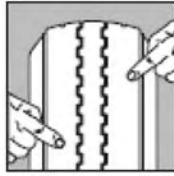

Shoulder wear (have inspected)

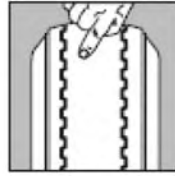

Center wear (have inspected)



Place a penny in the tire tread grooves as shown. If you can see the top of Lincoln's head, the tire is worn out and needs to be replaced.

TIRE MAINTENANCE AND SAFETY INFORMATION

Any tire, no matter how well constructed, may fail in use as a result of punctures, impact damage, improper inflation, overloading, or other conditions resulting from use or misuse. Tire failure may create a risk of property damage, serious personal injury or death.

WARNING!

Serious personal injury or death may result from a tire failure. Many tire failures are preceded by vibration, bumps, bulges or irregular wear. If a vibration occurs while driving your vehicle or you notice a bump, bulge or irregular wear, have your tires and vehicle evaluated by a qualified tire service professional.

To reduce the risk of tire failure, Bridgestone Firestone North American Tire, LLC strongly recommends you read and follow all safety information contained in this manual. In addition, we recommend periodic inspection and maintenance, if necessary, by a qualified tire service professional.

TIRE FAILURE WHILE DRIVING

WARNING!

It is not often that a properly maintained tire will “blow out” while you are driving. More commonly, if inflation pressure is lost, it will be gradual. If you do experience a blowout or sudden tire failure, the following information should be helpful:

- When the failure occurs, you may hear a loud noise, feel a vibration, and/or the vehicle may pull toward the side of the failed tire.
- DO NOT abruptly brake or turn.
- Slowly remove your foot from the accelerator, hold the steering wheel firmly, and steer to maintain your lane position.
- Once the vehicle has slowed, apply the brakes gently.
- Gradually pull over to the shoulder and come to a stop, as far off the road as possible.

TIRE INFLATION PRESSURE

Tires need proper inflation pressure to operate effectively and perform as intended. Tires carry the vehicle, passenger, and cargo loads and transmit the braking, acceleration, and turning forces. The vehicle manufacturer recommends the inflation pressures for the tires mounted on your vehicle.

WARNING!

Driving on tires with improper inflation pressure is dangerous.

- Under-inflation causes excessive tire heat build-up and internal structural damage.
- Over-inflation makes it more likely for tires to be cut, punctured, or broken by sudden impact.

These situations can cause a tire failure, even at a later date, which could lead to serious personal injury or death. Consult the vehicle tire information placard and/or owner’s manual for the recommended inflation pressures. In addition to tire damage, improper inflation pressure may also:

- Adversely affect vehicle ride and handling.
- Reduce tire tread wear.
- Affect fuel economy.

Therefore, follow these important recommendations for tire and vehicle safety, mileage, and economy:

- **Always keep the vehicle manufacturer’s recommended inflation pressure in all your tires, including the spare.**
- **Check their pressure monthly and before long trips or carrying extra weight.**

Your vehicle’s tire information placard and/or owner’s manual will tell you the recommended cold inflation pressure for all your tires, including the spare. Examples of placards are shown in Figures 1 and 2. Your placard may look differently and have different tire and loading information than that shown in either of the figures. **You must check the driver’s-side door edge or door jamb area for the actual placard that applies to your vehicle.** For questions about locating or understanding the tire information placard, consult your vehicle owner’s manual or ask a qualified tire service professional.

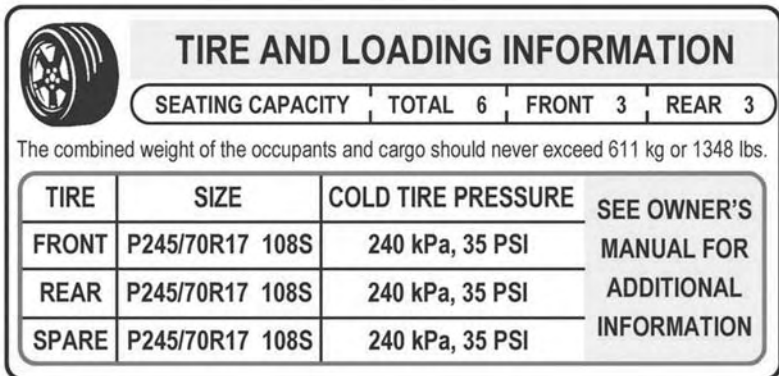

The placard features a tire icon on the left. The title "TIRE AND LOADING INFORMATION" is centered at the top. Below the title, a row of four boxes contains the seating capacity: "SEATING CAPACITY", "TOTAL 6", "FRONT 3", and "REAR 3". A note below this row states: "The combined weight of the occupants and cargo should never exceed 611 kg or 1348 lbs." The main data is presented in a table with four columns: "TIRE", "SIZE", "COLD TIRE PRESSURE", and "SEE OWNER'S MANUAL FOR ADDITIONAL INFORMATION".

TIRE	SIZE	COLD TIRE PRESSURE	SEE OWNER'S MANUAL FOR ADDITIONAL INFORMATION
FRONT	P245/70R17 108S	240 kPa, 35 PSI	
REAR	P245/70R17 108S	240 kPa, 35 PSI	
SPARE	P245/70R17 108S	240 kPa, 35 PSI	

Figure 1: EXAMPLE—Tire And Loading Information Placard



The image shows a rectangular placard with rounded corners. In the top left corner, there is a circular icon of a tire on a wheel. To the right of the icon, the text "TIRE INFORMATION" is written in a bold, sans-serif font. Below this header is a table with three columns: "TIRE", "SIZE", and "COLD TIRE PRESSURE". The table contains three rows of data: "FRONT" with size "P195/65R15 89T" and pressure "210 kPa, 30 PSI"; "REAR" with size "P195/65R15 89T" and pressure "240 kPa, 35 PSI"; and "SPARE" with size "T125/70R16 96M" and pressure "420 kPa, 60 PSI". Below the table, the text "SEE OWNER'S MANUAL FOR ADDITIONAL INFORMATION" is written in a smaller font.

TIRE	SIZE	COLD TIRE PRESSURE
FRONT	P195/65R15 89T	210 kPa, 30 PSI
REAR	P195/65R15 89T	240 kPa, 35 PSI
SPARE	T125/70R16 96M	420 kPa, 60 PSI

SEE OWNER'S MANUAL FOR ADDITIONAL INFORMATION

Figure 2: EXAMPLE—Tire Information Placard

Maximum Pressure Indicated on the Tire Sidewall: This is the maximum permissible inflation pressure for the tire only. The vehicle manufacturer's recommended tire pressures may be lower than, or the same as, the maximum pressure indicated on the tire sidewall. The vehicle manufacturer's specification of tire pressure is limited to your particular vehicle and takes into account your vehicle's load, ride, and handling characteristics, among other criteria. Since there may be several possible vehicle applications for a given tire size, a vehicle manufacturer may choose a different inflation pressure specification for that same size tire on a different vehicle. Therefore, always refer to the inflation pressure specifications on the vehicle tire information placard and/or in your vehicle owner's manual.

Different Tire Pressures for the Front and Rear Tires: For some vehicles, the recommended front and rear inflation pressures may be different (such as in the example shown in Figure 2). Make sure you take this into account during inflation pressure checks and when rotating tires.

Pressure Loss: Tires can lose 1 psi (7 kPa) per month under normal conditions and can lose 1 psi (7 kPa) for every 10° F (5.6° C) temperature drop. A puncture, leaking valve, or other damage could also cause inflation pressure loss. If a tire loses more than 2 psi (14 kPa) per month, have it checked by a qualified tire service professional.

TIPS FOR SAFE TIRE INFLATION

WARNING!

Inflating an unsecured tire is dangerous. If it bursts, it could be hurled into the air with explosive force resulting in serious personal injury or death. Never inflate a tire unless it is secured to the vehicle or a tire mounting machine.

- Check your tire pressures, including your spare tire, monthly and before long trips or carrying extra weight. Be sure to use an accurate pressure gauge.
- Check inflation pressure when the tires are “cold.” Tires are considered “cold” when the vehicle has been parked for three hours or more, or if the vehicle has been driven less than a mile at moderate speed.
- Never release pressure from a hot tire in order to reach the recommended cold tire pressure. Normal driving causes tires to run hotter and inflation pressure to increase. If you reduce inflation pressure when your tires are hot, you may dangerously underinflate your tires.
- If it is necessary to adjust inflation pressure when your tires are “hot,” set their pressure to 4 psi (28 kPa) above the recommended cold inflation pressure. Recheck the inflation pressure when the tires are cold.
- If your tires lose more than 2 psi (14 kPa) per month, the tire, the valve, or wheel may be damaged. Consult a qualified tire service professional for an inspection.
- Use valve caps to keep the valves clear of debris and to help guard against inflation pressure loss.

TIPS FOR SAFE LOADING

WARNING!

Driving your vehicle in an overloaded condition is dangerous. Overloading causes excessive tire heat build-up and internal structural damage. This can cause a tire failure, even at a later date, which could lead to serious personal injury or death. Consult the vehicle tire information placard, certification label, and owner's manual for the recommended vehicle load limits and loading recommendations.

- Always keep the vehicle manufacturer's recommended inflation pressure in all your tires, including the spare. Check their pressure monthly and before long trips or carrying extra weight.
- Never exceed the maximum load rating stamped on the sidewall of your tire.
- Never exceed the gross vehicle weight rating (GVWR) or front/rear gross axle weight ratings (GAWR) of your vehicle.
- Consult your vehicle owner's manual for load recommendations and special instructions (such as for trailer/towing and snow plow installations).

TIRE DAMAGE, INSPECTION AND SERVICE LIFE

Evaluation and maintenance of your tires is important to their performance and the service they provide to you. Over time and/or through use, the condition of a tire can change from exposure to everyday road conditions, the environment, damaging events such as punctures, and other external factors.

WARNING!

Driving on damaged tires is dangerous. A damaged tire can suddenly fail causing serious personal injury or death. Have your tires regularly inspected by a qualified tire service professional.

You should visually inspect your tires on a regular basis throughout their life, and you should have your tires periodically evaluated by a qualified tire service professional when your vehicle is serviced such as routine

maintenance intervals, oil changes, and tire rotations. In particular, note the following tips for spotting tire damage:

- After striking anything unusual in the roadway, have a qualified tire service professional demount the tire and inspect it for damage. A tire may not have visible signs of damage on the tire surface. Yet, the tire may suddenly fail without warning, a day, a week, or even months later.
- Inspect your tires for cuts, cracks, splits or bruises in the tread and sidewall areas. Bumps or bulges may indicate a separation within the tire body. Have your tire inspected by a qualified tire service professional. It may be necessary to have it removed from the wheel for a complete inspection.
- Inspect your tires for adequate tread depth. When the tire is worn to the built-in indicators at 2/32 inch (1.6 mm) or less tread groove depth, or the tire cord or fabric is exposed, the tire is dangerously worn and must be replaced immediately.
- Inspect your tires for uneven wear. Wear on one side of the tread or flat spots in the tread may indicate a problem with the tire or vehicle. Consult a qualified tire service professional.
- Inspect your wheels also. If you have a bent or cracked wheel, it must be replaced.
- Don't forget to check the spare tire.

Make sure your tires, including the spare tire, continue to be regularly inspected after 5 years of service to determine if they can continue in service. Even when your tires appear to be usable from their external appearance or the tread depth may have not reached the minimum wear out depth, it is recommended that all tires (including spare tires and "temporary use" spares) more than 10 years old be replaced with new tires.

The 10 year period after the date of production is not an indicator of actual service life for any individual tire. Some tires will need to be replaced before 10 years due to conditions such as punctures, impact damage, improper inflation, overloading, tread wear or other conditions involving use or misuse of the tire. If a tire is worn out or otherwise unserviceable from damage or conditions of use, it should be replaced regardless of when it was produced or placed in service.

The vehicle manufacturer may consider vehicle performance characteristics when making tire replacement recommendations. Consult your vehicle owner's manual for any information regarding tire service life and replacement and follow the recommendations applicable to your vehicle.

TIRE MANUFACTURE DATE

The tire manufacture date is determined by examining the DOT tire identification number, also known as the DOT serial number or code, which can be found on at least one sidewall near the wheel. It may be necessary to look on both sides of the tire to find the entire serial code. For more information on DOT serial codes, see "Tire Sidewall Labeling" in this manual.

Tires Produced Since 2000: The last four (4) digits of the serial code identify the week and year of production. In the example below, the tire was produced in the 18th week of 2000. Another example, a tire with a serial code ending in "2406" would have been produced in the 24th week of 2006.



Tires Produced Prior to 2000: The last three (3) digits of the serial code identify the week and year of production. For example, a tire with a code ending in "329" would likely have been produced in the 32nd week of 1999, but possibly produced in 1989. If in doubt, consult a qualified tire service professional.

TIRE REPAIRS

WARNING!

Driving on an improperly repaired tire is dangerous. An improper repair can be unreliable or permit further damage to the tire. The tire may suddenly fail, causing serious personal injury or death.

A complete inspection and repair of your tire in accordance with Rubber Manufacturers Association (RMA) procedures should be conducted by a qualified tire service professional. While the comprehensive procedures and recommendations for tire repair are beyond the scope of this manual, a proper tire repair includes the following:

- **The tire is demounted from the wheel for a complete inspection, inside and out.** Some damage to the tire may only be evident on the interior of the tire.
- **The puncture injury is 1/4 inch (6 mm) or less and must be within the tread area as shown in the graphic.** This helps ensure long-term tire and repair durability.
- **A patch is applied to the interior of the tire and the puncture hole is filled with a suitable plug/stem filler.** This helps ensure that the interior of the tire is adequately sealed to prevent inflation pressure loss and prevents contamination of the steel belts and other plies from the elements (such as water) in the outside world.

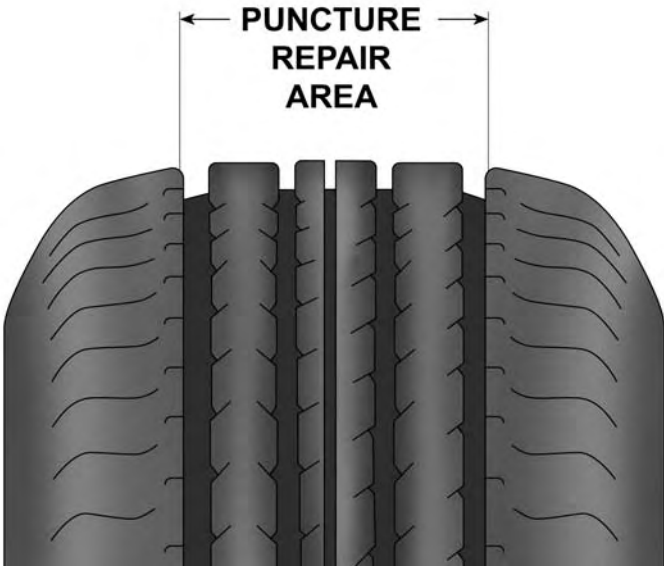

PATCH + PLUG/STEM



~~PATCH ONLY~~



~~PLUG/STEM ONLY~~



Additional notes about tire repairs:

- Not all punctured or damaged tires can be properly repaired; consequently, they must be replaced. NEVER repair a tire with any of the following conditions:
 - Wear to the tire's built-in tread wear indicators or to 2/32 inch (1.6 mm) remaining tread depth in any area of the tread.
 - With a puncture larger than 1/4 inch (6 mm).
 - With a puncture or other damage outside the repairable tread area (as shown in the graphic).
 - With a pre-existing, improper repair.

- Any tire repair done without removing the tire from the wheel is improper. The tire must be demounted from the wheel and the interior inspected for damage that may not be evident on the exterior of the tire.
- Using only a plug/stem, or using only a patch, is not a safe or proper repair. A patch must be applied to the interior of the tire and the puncture hole must be filled with a suitable plug/stem filler to prevent inflation pressure loss and contamination of the steel belts and other plies.
- NEVER substitute a tube for a proper repair or to remedy an improper repair.
- Tubes, like tires, should only be repaired by a qualified tire service professional.
- Some vehicle manufacturers do not recommend using repaired tires. Consult your vehicle owner's manual or contact the vehicle manufacturer before operating a repaired tire on your vehicle.

ASK how your tire will be repaired. ALWAYS insist on a proper tire repair.

Emergency/Temporary Sealant or Filler Repairs: An emergency/temporary sealant or filler injected into the tire, such as by aerosol can or injection/squeeze-tube, is not a proper repair and voids the tire Limited Warranty. A tire injected with such sealant/filler must be replaced by a qualified tire service professional as soon as possible.

WARNING!

Tell the tire service professional if you have used an aerosol fixer to inflate/seal the tire. Aerosol fixers could contain a highly volatile gas. Always remove the valve core outdoors, away from sources of excessive heat, flame, or sparks and completely deflate the tire before removing it from the wheel.

Speed Rating: The tire's speed rating is void if the tire is repaired, retreaded, damaged, abused, or otherwise altered from its original condition. Thereafter, it should be treated as a non-speed rated tire. See "Tire Speed Ratings" in this manual.

Improper repair voids the tire Limited Warranty. See "Limited Warranty" in this manual.

RFT (Run-Flat Technology) Tires: In addition to the above, there are recommendations specific to the repair of RFT tires; see “RFT Tires with Run-Flat Technology” in this manual.

TIRE MOUNTING AND OTHER SERVICING

WARNING!

Removing and replacing tires on wheels can be dangerous. Attempting to mount tires with improper tools or procedures may result in a tire explosion causing serious personal injury or death. This is only a job for a qualified tire service professional. Never perform tire service procedures without proper training, tools, and equipment.

This manual is not intended to provide proper training or service procedures for tire mounting, demounting, balancing, rotation, or repair. Please leave these tasks to qualified tire service professionals. For your safety and that of others:

- Always stand well clear of any tire mounting operation. This is especially important when the service operator inflates the tire. If the tire has been improperly mounted, it may burst with explosive force causing serious personal injury or death.
- Tires must match the width and diameter requirements of the wheels. For example, 16 inch diameter tires must only be mounted to 16 inch diameter wheels. Radial tires must only be mounted to wheels approved for radial tires.
- Wheels must be free of cracks, dents, chips, and rust. Tires must be free of bead damage, cuts, and punctures.
- Never inflate a tire beyond 40 psi (275 kPa) to seat the beads. Be absolutely certain beads are fully seated before adjusting inflation pressure to the level recommended for vehicle operation.
- Never put flammable substances in tire/wheel assemblies at any time. Never put any flammable substance into a tire/wheel assembly and attempt to ignite to seat the beads.
- Always stand well away from the work area when tires are being spin balanced either on or off the vehicle.

HIGH PERFORMANCE, LOW ASPECT RATIO TIRES

Many new vehicles come equipped from the factory with high performance and/or low aspect ratio tires. Generally, these tires provide increased vehicle handling capability, but may also have numerous engineering performance trade-offs associated with their designs.

- Low aspect ratio tires, with reduced sidewall height, may be more susceptible to damage from potholes, road hazards, and other objects such as curbs. This is true for the wheels as well. Therefore, as with all other tires, it is important to drive with care and maintain proper inflation pressure and load conditions. See “Tire Inflation Pressure” and “Tire Damage, Inspection and Service Life” in this manual.
- Some sports cars and other handling performance enhanced vehicles, including sedans and light trucks/SUVs, may be originally equipped with high performance tires that are more optimized for warmer weather use. Colder, winter weather traction may be reduced for these types of tires. Winter tires may be recommended by the vehicle manufacturer for colder weather application. See “Winter Tires,” the next section in this manual.
- High performance tires may also wear more quickly, ride more firmly, and produce more noise during operation.

Consult your vehicle owner’s manual and tire information placard, or a qualified tire service professional, for more information and specifics regarding these types of tires.

WINTER TIRES

WARNING!

Winter driving presents special challenges for vehicle mobility. The use of winter tires (including studs and chains)—while improving traction performance in snow and ice—requires special care with regard to acceleration, braking, cornering, and speed. It is important to drive with care, not only on snow and ice, but on dry and wet roads as well.

In winter driving conditions, vehicle control and safe operation under braking and cornering is especially dependent upon the rear tires. For this reason, winter tires are best applied to all wheel positions. Some

vehicles have specific recommendations regarding winter tire use; consult your vehicle owner's manual and tire information placard.

- If winter tires are to be applied to the front axle of any vehicle, they must also be applied to the rear axle for safe operation. This applies to all passenger cars and light trucks, including front wheel drive, 4x4, and all-wheel-drive vehicles.
- If winter tires are to be applied to the rear axle of any vehicle, it is recommended that they also be installed on the front axle.
- It is generally acceptable to apply a tire with a lower speed rating than your original tires for use in winter weather conditions; however, speed should be reduced accordingly. All winter tires should be the same speed rating. See "Tire Speed Ratings" in this manual.
- Winter tires used in warmer, summer weather conditions may wear more rapidly.
- Studded winter tires follow the same recommendations as above; consult a qualified tire service professional for information regarding any seasonal restrictions.

TIRE MIXING

WARNING!

Driving your vehicle with an improper mix of tires is dangerous. Your vehicle's handling characteristics can be seriously affected. You could have an accident resulting in serious personal injury or death. Consult your vehicle owner's manual and a qualified tire service professional for proper tire replacement.

HIGH SPEED DRIVING

WARNING!

Driving at high speed is dangerous and can cause a vehicle accident, including serious personal injury or death.

- Regardless of the speed and handling capabilities of your car and its tires, a loss of vehicle control can result from exceeding the maximum speed allowed by law or warranted by traffic, weather, vehicle, or road conditions.

- High-speed driving should be left to trained professionals operating under controlled conditions.
- No tire, regardless of its design or speed rating, has unlimited capacity for speed, and a sudden tire failure can occur if its limits are exceeded. See “Tire Speed Ratings,” the next section in this manual.

Refer to your vehicle owner’s manual for any tire pressure recommendations for high speed driving.

TIRE SPEED RATINGS

A tire bearing a letter “speed rating” designation indicates the tire’s speed capability according to standardized laboratory tests. This speed rating system is intended to permit comparison of the speed capabilities of different tires. When replacing your tires, consult your vehicle owner’s manual and tire information placard for recommendations, if any, concerning the use of speed rated tires.

- To avoid reducing the speed capability of the vehicle, replace a speed rated tire only with another tire having at least the same speed rating. It is the “top speed” of the “slowest” tire on the vehicle which limits the vehicle’s top speed without tire failure.
- The tire’s speed rating is void if the tire is repaired, retreaded, damaged, abused, or otherwise altered from its original condition. Thereafter, it should be treated as a non-speed rated tire.
- Non-speed rated tires are usually for ordinary passenger car or light truck service and not for high speed driving.
- For winter tires used in cold weather conditions, it is generally acceptable to apply a tire with a lower speed rating than your original tires; however, speed should be reduced accordingly. All winter tires should be the same speed rating. Some vehicles have specific recommendations regarding winter tire use; consult your vehicle owner’s manual and tire information placard. See “Winter Tires” in this manual.

These speed ratings are based on standardized laboratory tests under specific, controlled conditions. While these tests may relate to performance on the road, real-world driving is rarely identical to any test conditions. Your tire’s actual speed capability may be less than its rated speed since it is affected by factors such as inflation pressure, load, tire

condition (including damage), wear, vehicle condition (including alignment), driving conditions, and duration at which the speed is sustained. Use the following chart to compare the speed ratings of tires.

Speed Symbol	Speed Category*	
	mph	km/h
M	81	130
Q	99	160
R	106	170
S	112	180
T	118	190
U	124	200
H	130	210
V	149	240
Z**	>149	>240
W	168	270
Y	186	300
(Y)**	>186	

The tire's speed rating designation appears on the tire sidewall with the tire size. Examples:

P275/40ZR17		max > 149 mph (240 km/h)****
P275/40R17	93W	max = 168 mph (270 km/h)
P275/40ZR17	93W	max = 168 mph (270 km/h)
P275/40ZR17	93Y	max = 186 mph (300 km/h)
P275/40ZR17	93(Y)	max > 186 mph (300 km/h) ****

* In standardized laboratory tests that relate to highway speeds. Actual tire speed and performance capability depend on factors such as inflation pressure, load, tire condition, wear, and driving conditions.

** Any tire having a maximum speed capability above 149 mph (240 km/h) may, at the tire manufacturer's discretion, include a "Z" in the size designation (i.e. P275/40ZR17).

*** For tires having a maximum speed capability above 186 mph (300 km/h), a "Z" must appear in the size designation and a "Y" marked in brackets (as shown) in the service description.

**** Consult the tire manufacturer for maximum speed capability.

TIRE SPINNING

WARNING!

Spinning a tire to remove a vehicle stuck in mud, ice, snow, or wet grass can be dangerous. A tire spinning at a speedometer reading above 35 mph (55 km/h) can in a matter of seconds reach a speed capable of disintegrating a tire with explosive force. Under some conditions, a tire may be spinning at a speed twice that shown on the speedometer. This could cause serious personal injury or death to a bystander or passenger. Never spin a tire above a speedometer reading of 35 mph (55 km/h).

RADIAL TIRE ROTATION

The purpose of tire rotation is to minimize irregular or uneven wear caused by maintaining a tire in one rotation direction and one position over an extended period. Rotate tires as recommended by the vehicle manufacturer or every 5,000 miles. Individual tire pressures must be checked after rotation and adjusted to the vehicle manufacturer's recommendation for the tire's new location on the vehicle. Vehicle alignment should be checked if irregular wear is evident.

For vehicles with a "temporary use" spare tire, follow the vehicle manufacturer's recommended pattern for rotation, or, if not provided, the following may be used:

Rear and Four Wheel Drive Vehicles

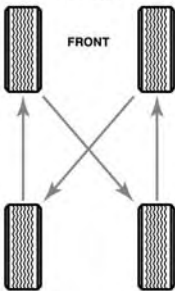

Front Wheel Drive Vehicles

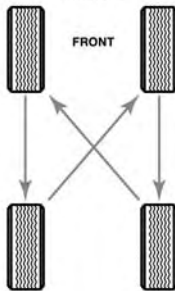

Six Tire Light Truck Vehicles

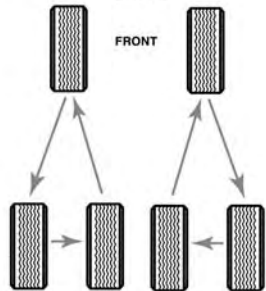

If your spare is the same size, load rating, and type of tire as your road tires, it should be included in the tire rotation process. For vehicles with a “full-size” spare, the following rotation patterns may be used:

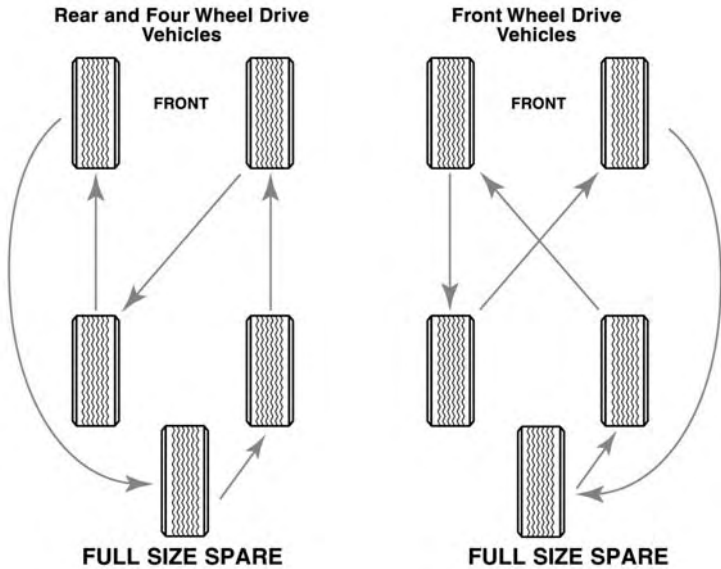

NOTE:

- Never include a “temporary use” spare tire in the rotation.
- Tires with directional tread patterns must be rotated so the direction of revolution does not change; this may require demounting/mounting the tires.
- Special attention should be given if your vehicle is equipped with a Tire Pressure Monitoring System (TPMS). Rotation of your tires may affect the system; consult your vehicle owner’s manual or a qualified tire service professional.
- Some vehicles may have different size tires/wheels on front and rear which would restrict rotation. Always check and follow the vehicle manufacturer’s rotation recommendation.
- To use a full-size spare in the rotation pattern on vehicles with dual rear wheels, consult your vehicle owner’s manual for the recommended procedures or consult the vehicle manufacturer.

YOUR SPARE TIRE

Consult your vehicle owner's manual for proper application of your spare tire. Your car may be equipped with a "temporary use" spare tire; this spare may differ in size and construction from the other tires on your vehicle.

WARNING!

Check inflation pressure before use. Failure to have proper inflation pressure when using your spare tire can result in serious personal injury or death. See Tire Inflation Pressure in this manual.

WARNING!

Mounting a "temporary use" tire on a wheel which is not specifically designed for it, or placing another type tire on a wheel designated for temporary use can be dangerous. Your vehicle's handling characteristics can be seriously affected. You could have an accident resulting in serious personal injury or death. Consult your vehicle owner's manual for proper application of your "temporary use" spare tire.

The spare tire in your vehicle is intended to be used as a spare when needed. The spare tire carrier is not intended to be used for long term storage, except for "temporary use" tires. If your spare is the same size, load rating, and type of tire as your road tires, it should be included in the tire rotation process; see "Radial Tire Rotation" in this manual for more information.

The spare should be included in regular tire inspections and inflation pressure checks. In addition, it should be replaced 10 years after date of manufacture, regardless of condition or tread depth. For more information, see the "Tire Damage, Inspection and Service Life" in this manual.

TIRE STORAGE

Tires should be stored indoors in a cool, dry place where water cannot collect inside them. Tires should be placed away from electric generators/motors and sources of heat such as hot pipes. Storage surfaces should be clean and free of grease, gasoline or other substances which can deteriorate the rubber.

WARNING!

Improper storage can damage your tires in ways that may not be visible and can lead to a failure resulting in serious personal injury or death.

The spare tire in your vehicle is intended to be used as a spare when needed. The spare tire carrier is not intended to be used for long term storage, except for “temporary use” tires. For more information, see “Your Spare Tire” and “Radial Tire Rotation” in this manual.

TIRE SERVICE CUSTOMER SATISFACTION

Normal tire maintenance and Limited Warranty services are available at locations across the U.S.A. and Canada. For more information, visit us on the internet at www.bridgestonetire.com, or please call the Technical Service Department:

U.S.A.: 800-356-4644 or Canada: 800-267-1318 .

Additional information on the care and service of automobile and light truck tires is available from the following organizations:

Rubber Manufacturers Association 1400 K Street, N.W. Washington, DC 20005-2403 www.rma.org

Rubber Association of Canada 2000 Argentinia Road, Plaza 4, Suite 250 Mississauga, Ontario L5N 1W1 www.rubberassociation.ca

TIRE REGISTRATION

Registration of your tires is an important safety precaution since it enables the manufacturer to notify you in the event of a recall. When you purchase replacement tires, the retailer will provide a registration card on which the tire identification numbers have been recorded; fill in your name and address on the card and mail it promptly. Some retailers may submit the registration for you. You do not need to register tires which come as original equipment on new vehicles—the vehicle and tire manufacturers handle that for you.

RFT TIRES WITH RUN-FLAT TECHNOLOGY



If your vehicle is equipped with Bridgestone or Firestone brand RFT tires, this chapter presents specific maintenance and safety issues asso-

ciated with these tires that are in addition to those covered elsewhere in this manual.

What is RFT? Run-Flat Technology tires are extraordinary tires that utilize specially designed components to temporarily support your vehicle in the event of inflation pressure loss, such as from a puncture. This gives you the ability to drive to a convenient and safe location to change your tire (if equipped with a spare) or have it inspected for possible repair or replacement.

Naturally, certain run-flat and low pressure operating limitations apply, which varies according to the specific self-supporting tire design. Like all tires, during normal operation, they must be properly inflated and maintained. Regardless of the design or quality, no tire is indestructible.

RFT—How to Identify: Bridgestone and Firestone brand tires are marked on the sidewalls, near the wheel, with the RFT logo (shown above).

RFT INFLATION PRESSURE

Like other tires, RFT tires need proper inflation pressure maintenance for safe operation and to achieve the maximum tire life and performance. Check inflation pressures monthly and before long trips or carrying extra weight. Use an accurate tire gauge and check pressures when the tires are cold. Follow the vehicle manufacturer's recommendation for inflation pressure settings as indicated on the vehicle tire information placard and/or in the vehicle owner's manual. Do not forget the spare, if applicable. See "Tire Inflation Pressure" in this manual.

TIRE PRESSURE MONITORING SYSTEM (TPMS)

A functioning tire pressure monitoring system (TPMS) must be used with your RFT tires. Because these tires ride so well even without inflation pressure, the TPMS may be necessary to alert you of an inflation pressure loss condition. When alerted, follow the instructions in your vehicle owner's manual and see "Run-Flat or Low Tire Pressure Operation," the following section in this manual.

The vehicle or TPMS manufacturer may advise checking the TPMS regularly to confirm it is in working order. In addition, a new pressure sensor, certain components, or reprogramming may be necessary when a tire is serviced. Consult your vehicle owner's manual, vehicle manufacturer, or a Bridgestone Firestone Run-Flat Certified Retailer for questions regarding TPMS operation and service.

RUN-FLAT OR LOW TIRE PRESSURE OPERATION

WARNING!

Serious personal injury or death may result from a tire failure or accident due to improper run-flat or low tire pressure operation. Read and follow the instructions below, and the other maintenance and safety recommendations elsewhere in this manual.

General Instructions

The Tire Pressure Monitoring System (TPMS) required in your vehicle may have different methods of alerting you when your tire has lost inflation pressure. The international standard for the definition of run-flat operation is pressure at or below 10 psi (70 kPa); however, some vehicle manufacturers may have established a different pressure limit. Consult your vehicle owner's manual for the details of your TPMS. Once the TPMS has indicated that a tire has reduced inflation pressure, the run-flat mode of operation has commenced. During this phase of operation, please follow these instructions:

- **Reduce speed as much as safely and reasonably possible; do not exceed 50 mph (80 km/h).** The greater the speed, the less distance the tire can travel.
- **Avoid abrupt or aggressive acceleration, braking, or cornering maneuvers as much as safely and reasonably possible.** Pot holes and other road hazards should be avoided. Careful driving limits potential damage to the tire, wheel, and vehicle.
- **Proceed to a safe and convenient location for tire service as soon as possible.** Take note of your mileage; your operation distance is limited. See "Distance—How Far You Can Drive," the next section in this manual.

- **If an unusual vibration or vehicle handling difficulty arises, stop driving as soon as safely and reasonably possible.** The tire may be about to suddenly fail. Release the accelerator and gradually reduce speed. The tire will need to be replaced before proceeding.
- **If towing a trailer, stop driving as soon as safely and reasonably possible. In this condition, it is potentially dangerous to operate a vehicle/trailer combination.** If possible, disconnect the trailer and proceed as noted above. Do not continue to tow any trailer until proper tire service or replacement has been performed.
- **Do not touch a tire recently run-low or run-flat (it may be very hot).** Allow the tire to cool before handling.

DISTANCE—HOW FAR YOU CAN DRIVE

Factors affecting run-flat or low tire pressure operating distance include vehicle speed, load, and maneuvering; the amount of inflation pressure loss; the extent of any tire damage; and ambient temperature.

The tire may be marked on the sidewall with run-flat or low tire pressure operating speed and/or distance limitations, which vary by tire design and vehicle application (consult your vehicle owner's manual). By international standard, RFT tires have a baseline limitation in run-flat mode of the following:

Maximum Speed:	50 mph (80 km/h)
Maximum Distance:	50 miles (80 km)

NOTE:

- Maximum distance values are determined under controlled conditions, which may vary in actual use.
- Your mileage capability may be less, or more, depending on your specific operating conditions.
- If in doubt, do not exceed the 50 mile (80 km) limitation.
- Seek tire service as soon as possible to minimize tire damage.

SPECIAL SERVICE AND REPAIR ISSUES

Run-Flat Certified Retailers

Because of the advanced technology and design of RFT tires and the required tire pressure monitoring systems (TPMS), Bridgestone Firestone Run-Flat Certified Retailers are specially trained to sell and service RFT tires.

Run-Flat Certified Retailers have the necessary equipment and are specially trained to properly mount and demount RFT tires and to handle TPMS devices. **Conventional mounting equipment may irreparably damage RFT tires and an improper repair is unsafe and will void the Limited Warranty.** Accordingly, it is important to go to a Bridgestone Firestone Run-Flat Certified Retailer for tire maintenance and replacement.

Call toll-free 1-877-BFS-4RFT or, 877-237-4738 or visit www.bridgestonetire.com to locate the nearest Bridgestone Firestone Run-Flat Certified Retailer.

Inspection after Run-Flat or Low Pressure Operation

Following run-flat or low tire pressure operation, or in the event of any other tire damage or unusual condition, it is very important to obtain a proper and complete tire evaluation as soon as possible.

Rotation

Follow the vehicle manufacturer's recommendations, or rotate every 5,000 miles per the recommendations in this manual (see "Radial Tire Rotation"). In some cases, TPMS devices require reprogramming with each tire rotation.

RFT Tire Replacement

Do not replace or mix RFT tires with conventional tires, unless on an emergency/temporary basis. Conventional tires do not have run-flat capability and the handling characteristics of the vehicle with these tires may be different. If a conventional tire is used on an emergency/temporary basis, verify that its size, load capacity, inflation pressure, and speed rating specifications meet the requirements of the vehicle. Replace any conventional tire with the proper RFT tire as soon as possible.

RFT Tire Damage and Repair

No tire, regardless of its design or quality is indestructible. RFT tires can be ultimately rendered unusable due to a puncture or other road hazard as well as from improper run-flat or low tire pressure operation. Some punctures may be repaired under certain restrictions and prescribed procedures.

When driven flat or with low pressure, factors affecting reparability include vehicle speed, load, and maneuvering; the amount of inflation pressure loss; and ambient temperature. In any situation, the extent and location of direct damage from a puncturing object or other road hazard are also critical factors.

RFT tires are not repairable in any of the following situations:

- If the tire was operated with inflation pressure less than 15 psi (100 kPa).
- Abrasion or other damage is present on the exterior tread, sidewall or bead areas.
- Abrasion, wrinkling, or separation is present on the tire interior.
- Any condition or damage is present that disqualifies repair of a conventional tire.

Run-Flat Certified Retailers will fully inspect your tire, inside and out, to determine if the tire can be repaired. Tire damage is not always visible from the outside and the tire must be removed from the wheel for a complete inspection. For more information, see the section “Tire Repairs” in this manual.

NOTE: Some vehicle manufacturers do not recommend using repaired tires. Consult your vehicle owner’s manual or contact the vehicle manufacturer before operating a repaired tire on your vehicle.

REFERENCE INFORMATION

TIRE SIDEWALL LABELING

A lot can be learned by reading the tire’s sidewall. The following figures show typical information on the sidewall of passenger (Figure 3) and light truck tires (Figure 4):

Figure 3: Typical Passenger Tire Markings

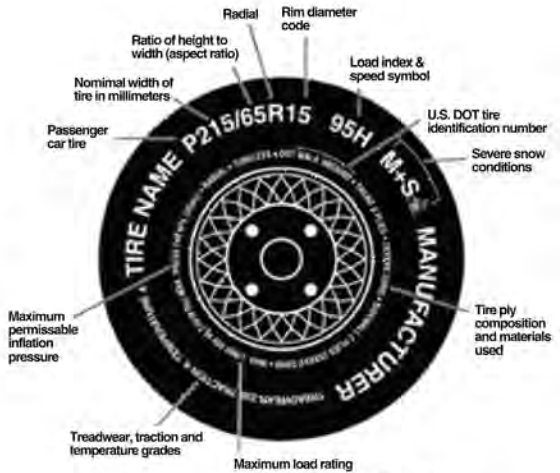
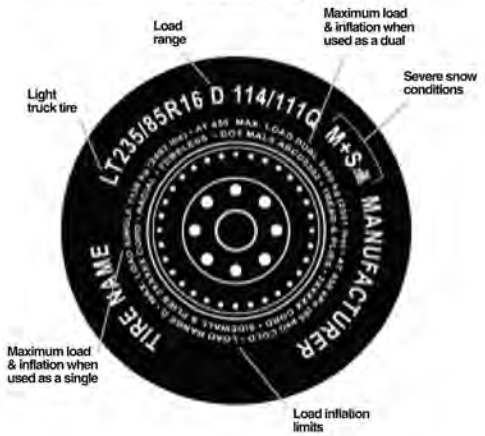

Figure 4: Typical Light Truck Tire Markings



Tire Size, Load Range, Load Index, and Speed Symbol:

Example	Tire Size	Load Index	Speed Symbol	Load Range
Figure 3	P215/65R15	95	H	-
Figure 4	LT235/85R16	114/111	Q	D

DOT Symbol and Tire Identification Number: The “DOT” symbol constitutes a certification that the tire conforms to applicable U.S. Department of Transportation motor vehicle safety standards (for tires). Following the “DOT” symbol is the tire identification number, also known as the DOT serial number or code. For example:

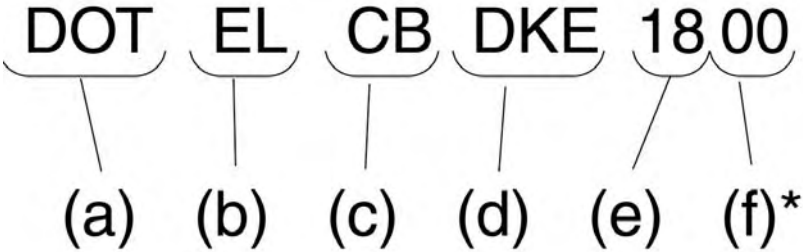

(a) DOT Symbol

(b) Manufacture Plant Code

(c) Tire Size Code

(d) Tire Manufacturer’s Code

(e) Week of Production (01-52)

(f) Year of Production (last two digits of year)

* For tires produced from 2000-on. In the example above, the tire was produced in the 18th week of 2000. For tires produced prior to 2000, there is one digit in group (f) which identifies the last digit of the year of production, i.e. “329” would likely signify the 32nd week of 1999, but could possibly signify the 32nd week of 1989. If in doubt, consult a qualified tire service professional.

The DOT symbol and tire identification number can be found on at least one sidewall near the wheel. The other sidewall may have a partial serial code that excludes (e) and (f) above.

Maximum Load and Inflation: The maximum load and maximum inflation pressure is marked on each sidewall in metric and English units. For example:

MAX LOAD 685 kg (1,510 lbs) AT 240 kPa (35 psi) MAX PRESS

NOTE: The load and inflation values marked on the tire sidewall are maximum permissible values for the tire only. Never assume that these values are the actual maximum load capacity or recommended tire pressure values for your vehicle. See “Tire Inflation Pressure,” “Tips for Safe Tire Inflation,” and “Tips for Safe Loading” in this manual.

Ply Composition and Materials: The actual number of plies in the sidewall and tread area and the generic name(s) of their cord material(s) are marked on at least one sidewall. For example:

- TREAD 2 PLY POLYESTER + 2 STEEL
- SIDEWALL 2 PLY POLYESTER

Radial: Radial ply tires will have the word "radial" on at least one sidewall. An "R" in the tire size designation also indicates radial ply construction.

Tubeless or Tube Type: Tires are marked as either "tubeless" or "tube type," whichever is applicable, on at least one sidewall.

UNIFORM TIRE QUALITY GRADING

The Uniform Tire Quality Grading ("UTQG") standards are intended to assist you in making an informed choice in your purchase of passenger car tires by providing information indicating relative performance of these tires in the areas of tread wear, wet braking traction (straight-ahead), and temperature resistance. All passenger car tires must conform to federal safety requirements in addition to these grades.

Treadwear

The treadwear grade is a comparative rating based on the wear rate of the tire when tested under controlled conditions on a specified government test course. For example, a tire graded 150 would wear one and one half (1 1/2) times as well on the government course as a tire graded 100. The relative performance of tires depends upon the actual conditions of their use, however, and may depart significantly from the norm due to variation in driving habits, service practices and differences in road characteristics and climate.

Traction

The traction grades, from highest to lowest, are AA, A, B, and C. Those grades represent the tire's ability to stop on wet pavement as measured under controlled conditions on specified government test surfaces of asphalt and concrete. Warning: The traction grade assigned to a tire is based on straight-ahead braking traction tests, and does not include acceleration, cornering, hydroplaning, or peak traction characteristics.

Temperature

The temperature grades are A (the highest), B, and C, representing the tire's resistance to the generation of heat and its ability to dissipate heat when tested under controlled conditions on a specified indoor laboratory test wheel. Sustained high temperature can cause the material of the tire to degenerate and reduce tire life, and excessive temperature can lead to sudden tire failure. The grade C corresponds to a level of performance which all passenger car tires must meet under the Federal Motor Vehicle Safety Standard No.109. Grades B and A represent higher levels of performance on the laboratory test wheel than the minimum required by law.

WARNING!

The temperature grade is established for a tire that is properly inflated and not overloaded. Excessive speed, underinflation, or excessive loading, either separately or in combination, can cause heat buildup and a possible tire failure.

LIMITED WARRANTY



ORIGINAL EQUIPMENT

PASSENGER AND LIGHT TRUCK TIRES

Including  Tires with Run-Flat Technology

ELIGIBILITY

This Limited Warranty covers BRIDGESTONE and FIRESTONE brand passenger and light truck tires, including RFT and temporary spare tires, originally installed by the vehicle manufacturer on a new vehicle. You are covered under the terms of this Limited Warranty if the tire was produced after July 4, 2004 (DOT serial 2704 or later) and has been used only on the vehicle on which it was originally installed in non-commercial service.

WHAT IS WARRANTED AND FOR HOW LONG

Before wearing down to 2/32 inch (1.6 mm) remaining original tread depth (i.e. worn down to the top of the built-in indicators in the tread grooves) and within 6 years from the date of purchase (proof of purchase date required; without proof of purchase date, then within 6 years from the date of tire manufacture), for any reason other than those excluded in the section entitled "What This Limited Warranty Does Not Cover," any eligible tire that becomes unusable for any reason within the manufacturer's control will be replaced with an equivalent new tire on the basis set forth in this Limited Warranty.

WHAT THIS LIMITED WARRANTY DOES NOT COVER

This Limited Warranty does not cover the following:

1. Tire damage or irregular wear due to:
 - A. **Road hazards**, including, without limitation: Puncture, cut, impact break, stone drill, bruise, bulge, snag, etc.

- B. **Improper use or operation**, including, without limitation: Improper inflation pressure, overloading, tire/wheel spinning, use of an improper wheel, tire chain damage, misuse, misapplication, negligence, tire alteration, or for racing or competition purposes.
 - C. **Insufficient or improper maintenance**, including, without limitation: Failure to rotate tires as recommended in this manual, wheel misalignment, worn suspension components, improper tire mounting or demounting, tire/wheel assembly imbalance, or other vehicle conditions, defects, or characteristics.
 - D. **Contamination or degradation** by petroleum products or other chemicals, fire or other externally generated heat, or water or other material trapped inside the tire during mounting or inflation.
 - E. **Improper repair**. Improper repair voids this Limited Warranty
 - F. **For RFT tires only, improper run-flat or low tire pressure operation**, including, without limitation: Exceeding speed, distance, or other run-flat/lowpressure operation limitations.
2. Rapid tread wear or wear-out. Original equipment tires have no mileage warranty.
 3. Weather/ozone cracking after 4 years from date of tire manufacture.
 4. Ride disturbance or vibration after 1/32 inch (0.8mm) of tread wear use.
 5. Tires with sealant, balance, or other filler material that was not originally applied or inserted by the tire manufacturer.
 6. Tires used in commercial service.
 7. Tires purchased and normally used outside the United States and Canada.
 8. The cost of applicable federal, state, and local taxes.
 9. Failure to follow any of the safety and maintenance recommendations or warnings contained in this manual.

This Limited Warranty is in addition to and/or may be limited by any other applicable written warranty you may have received concerning special tires or situations.

REPLACEMENT PRICE

Radial passenger and light truck tires adjusted under this Limited Warranty will be replaced free of charge during the first 25% of tread wear or within 12 months from the date of purchase (proof of purchase date required; without proof of purchase date, then within 12 months from the date of tire manufacture), whichever occurs first. During the free replacement period, mounting and balancing are included free of charge.

To determine the replacement price after the free tire replacement period, the percent of used tread wear is multiplied by the current selling price for the replacement tire(s). The appropriate taxes, mounting, balancing, disposal fee, and other service charges may be added to the adjustment replacement price.

In Canada, the tire will be adjusted at dealerships (subject to dealer discretion) at a predetermined "Adjustment Price."

REPLACEMENT WARRANTY

If you receive a replacement tire under this Limited Warranty, it will be covered by the manufacturer's warranty, if any, given on that tire at that time.

WHERE TO GO

Tire adjustments under this Limited Warranty will only be made at an authorized Bridgestone Firestone retailer. Consult a phone directory (often listed in the Yellow Pages under "Tire Dealers") or the internet at www.bridgestonetire.com for the location nearest you.

CONSUMER RIGHTS

This Limited Warranty gives you specific legal rights, and you may also have other rights which vary from state to state or in Canada from province to province.

CONDITIONS AND EXCLUSIONS

To the extent permitted by law, Bridgestone Firestone North American Tire, LLC disclaims all other warranties, including but not limited to the implied warranties of merchantability and fitness for a particular purpose and any liability for incidental and consequential damages, loss of time, loss of vehicle use, or inconvenience. Some states do not allow the exclusion or limitation of incidental or consequential damages, so the above limitation or exclusion may not apply to you.

BRIDGESTONE® - FIRESTONE®

This Limited Warranty applies only to consumers actually using the tire in the United States and Canada. For warranty conditions outside the United States and Canada, see your local Bridgestone Firestone distributor.

Obligations under this policy may not be enlarged or altered by anyone.

In accordance with Federal Law, this Limited Warranty has been designated as a "Limited Warranty." Nothing in this Limited Warranty is intended to be a representation that tire failures cannot occur. This Limited Warranty is given in the United States by Bridgestone Firestone North American Tire, LLC, 535 Marriott Dr., Nashville, TN 37214 and in Canada by Bridgestone Firestone Canada Inc., 5770 Hurontario St., Suite 400, Mississauga, Ontario, Canada L5R 3G5.

OWNER'S OBLIGATIONS

In order to keep this Limited Warranty valid, we require you to have your tires regularly inspected and rotated per the recommendations outlined in the sections of this manual entitled "Tire Damage, Inspection and Service Life" and "Radial Tire Rotation" and to furnish proof of same in order to receive an adjustment. Such proof should show the date, mileage, and servicing location. A sales receipt containing this information will suffice. In addition, a "Maintenance Record" is included on the back cover of this manual. It is your obligation to maintain proper tire inflation pressures as specified by the vehicle manufacturer and to operate the vehicle within tire/vehicle load capacity and speed limitations. It is also your obligation to maintain proper wheel alignment and tire/wheel assembly balance. To request an adjustment, you must present the tire to an authorized Bridgestone Firestone retailer. Complete and sign the customer section of the Bridgestone Firestone North American Tire, LLC Limited Warranty adjustment form and pay appropriate replacement price, taxes, disposal fee, and service charges, if any.



ARBITRATION

You and Bridgestone Firestone North American Tire, LLC agree that all claims, disputes, and controversies between you and it, including any of its agents, employees, successors, or assigns, arising out of or in connection with this Limited Warranty, or any other warranties, express or implied, including a failure of warranty and the validity of this arbitration clause, but excluding claims for personal injury or property damage, shall be resolved by binding arbitration between you and it, according to the formal dispute resolution procedures of the National Arbitration

Forum, under the Code of Procedure then in effect. This arbitration will be conducted as a document hearing. If you request any procedures beyond a document hearing, you will be responsible for all fees, including filing and administrative fees, above and beyond the fees required for document hearings.

The arbitration between you and Bridgestone Firestone North American Tire, LLC shall not include any other customers, be combined or consolidated in any fashion with arbitrations involving other customers, or proceed in any form of class action in which the claims of numerous customers are considered together. Any award of the arbitrator(s) may be entered as a judgment in any court of competent jurisdiction. The arbitrators will have no authority to award punitive or other damages not measured by the prevailing party's actual damages, except as may be required by statute. Information may be obtained and claims may be filed at any office of the National Arbitration Forum or at P.O. Box 50191, Minneapolis, MN 55405.

VEHICLE MANUFACTURER'S RECOMMENDED INFLATION PRESSURE

											
						<p style="font-size: 24px; font-weight: bold;">Front</p> <p style="font-size: 24px; font-weight: bold;">_____ PSI</p>			<p style="font-size: 24px; font-weight: bold;">Rear</p> <p style="font-size: 24px; font-weight: bold;">_____ PSI</p>		
J	F	M	A	M	J	J	A	S	O	N	D

CONTINENTAL TIRE

LIMITED WARRANTY AND ADJUSTMENT POLICY FOR ORIGINAL EQUIPMENT PASSENGER CAR & LIGHT TRUCK TIRES (Including TEMPORARY SPARE Tires)

This booklet also includes important safety warnings.

1. ELIGIBILITY

This Limited Warranty and Adjustment Policy applies to the original owner of new Continental brand passenger and light truck (LT) tires that are the new vehicle original equipment tires bearing the Continental brand name and D.O.T. Tire Identification Number, operated in normal service, and used on the same vehicle on which they were originally installed according to the vehicle manufacturer's recommendations.

Tire(s) on any vehicle registered and normally operated outside the United States and Canada are excluded from eligibility under this Limited Warranty and Adjustment Policy.

2. WHAT IS THE ADJUSTMENT POLICY AND HOW LONG IS IT APPLICABLE? BASIC COVERAGE:

Eligible Tires are covered by this Warranty for a maximum of 72 months from the date of purchase, determined by the new vehicle registration date or new vehicle sales invoice showing date of purchase.

Where to Go for Warranty Replacement: Contact the dealer from where you purchased the vehicle or an alternate authorized Continental brand tire dealer (Authorized Dealer) to determine the eligible warranty coverage for your tires and how to proceed from there.

Free Replacement Period: PASS & LT If an eligible Continental brand PASS or LT tire becomes unserviceable from a warrantable condition, other than those listed under Section 3, during the first 12 months or first 2/32nds of an inch (1.6 mm) of treadwear (whichever comes first), it will be replaced with a **comparable new Continental brand tire FREE OF CHARGE, including mounting and balancing (excluding on line orders). Owner pays all applicable taxes.

CONTINENTAL TIRE

TEMPORARY SPARE: If a TS Tire becomes unserviceable from a condition other than those listed in Section 3, during the first 1/32nd (0.8 mm) of treadwear, then it will be replaced with a **comparable new Continental brand TS tire FREE OF CHARGE, including mounting and balancing. The owner pays all applicable taxes. After this "Free Replacement Period" for your TS tire expires, no warranty claim will be accepted.

After the Free Replacement Period: The tire (except temporary spare tire) may still be eligible for a pro rata replacement up to 72 months from date of original purchase until the tread is worn down to the tread wear indicators (2/32nds of an inch or 1.6 mm of tread remaining.) If an eligible tire becomes unserviceable under the stipulations of this Limited Warranty and Adjustment policy it will be replaced with a **comparable new Continental brand tire, charging the owner a pro-rated amount. Owner pays all applicable taxes (including F.E.T.), mounting and balancing charges.

The replacement tire price will be determined by multiplying the percentage of the useable tread worn by the Dealers Selling Price (excluding all applicable taxes) at the time of the adjustment. The useable tread is the original tread down to the tread wear indicators (2/32nds of an inch or 1.6 mm of tread remaining.)

** A "comparable" new Continental brand tire may be of either the same tire line or the same basic construction but with a different sidewall or tread configuration. If a higher priced tire is selected, the consumer will pay the difference in price.

3. WHAT IS NOT COVERED BY THIS WARRANTY

THE FOLLOWING ARE NOT COVERED:

- Road Hazard: Any tire with road hazard damage, which includes, but is not limited to: cuts, snags, punctures, bruises, and impact breaks.
- Ride/Vibration: Any ride/vibration complaint after the first 2/32nds (1.6 mm) of an inch of treadwear or 12 months of service, whichever comes first.
- Repairs: If a tire is returned under complaint and the reason for the tire's disablement is in any way associated with a repair, or with the situation that led to the repair, the manufacturer's warranty is invalidated.
- Mileage: Mileage is not covered under this policy.

- Improper operation or maintenance: This includes, but is not limited to, effects caused by:
 - A. **Improper tire inflation and/or improper load/speed practices:**
These practices can cause excessive operational temperatures and stresses that exceed the tire's capabilities.
 - B. **Improper or insufficient tire rotation:**
 - C. **Improper vehicle alignment**
 - D. **Damage due to:**
 - Rim irregularities or rim damage
 - Snow chains
 - Vehicle mechanical problems, including brake problems, and vehicle wheel alignment.
 - Extreme temperature exposure
 - Negligent and abusive driving such as tire spinning, or racing;
 - Improper tire storage
 - Automotive accident
 - Chemical corrosion or fire
 - Use contrary to the vehicle manufacturer's tire recommendations.
 - Misuse or misapplication
- **Improper Mounting or Demounting**
- **Alteration:** such as, but not limited to, adding a white inlay on blackwall, tread regrooving, tire truing or siping, or adding sealant materials to the tire.
- **Weather checking/cracking:** Not covered after 48 months from the date of purchase.
- **Failure to observe safety and maintenance precautions set forth in Section 6.**

ATTENTION AUTHORIZED DEALERS: CTA RESERVES THE RIGHT TO THE FINAL INSPECTION DECISION FOR ALL RETURNED TIRES ON CONDITIONS UNDER SECTION 3.

THIS WARRANTY IS MADE IN LIEU OF ALL OTHER WARRANTIES, EXPRESS OR IMPLIED, AND CTA EXPRESSLY DISCLAIMS ALL IMPLIED WARRANTIES, INCLUDING, BUT NOT LIMITED TO, WARRANTIES OF MERCHANTABILITY OR FITNESS FOR A PARTICULAR PURPOSE. SOME U.S. STATES

AND/OR CANADIAN PROVINCES DO NOT ALLOW LIMITATIONS ON THE DURATION OF AN IMPLIED WARRANTY, SO THE ABOVE MAY NOT APPLY TO YOU.

TO THE EXTENT PERMITTED BY LAW, CTA DISCLAIMS LIABILITY FOR ALL CONSEQUENTIAL AND INCIDENTAL DAMAGES. THE REMEDIES SET FORTH IN THIS LIMITED WARRANTY ARE THE SOLE AND EXCLUSIVE REMEDIES FOR BREACH OF WARRANTY. SOME U.S. STATES AND/OR CANADIAN PROVINCES DO NOT ALLOW THE EXCLUSION OR LIMITATION OF INCIDENTAL OR CONSEQUENTIAL DAMAGES, SO THE ABOVE LIMITATION OR EXCLUSION MAY NOT APPLY TO YOU. THIS WARRANTY GIVES YOU SPECIFIC LEGAL RIGHTS, AND YOU MAY ALSO HAVE OTHER RIGHTS WHICH VARY FROM U.S. STATE TO STATE AND/OR CANADIAN PROVINCE TO PROVINCE.

THIS IS THE ONLY EXPRESS WARRANTY MADE BY CTA. NO CTA EMPLOYEE, RETAILER, OR DEALER HAS THE AUTHORITY TO MAKE ANY WARRANTY, REPRESENTATION, PROMISE OR AGREEMENT ON BEHALF OF CTA EXCEPT AS EXPRESSLY WRITTEN IN THIS LIMITED WARRANTY AND ADJUSTMENT POLICY. IN OBSERVANCE OF U.S. FEDERAL LAW, THIS LIMITED WARRANTY AND ADJUSTMENT POLICY HAS BEEN DESIGNATED A "LIMITED WARRANTY". CTA DOES NOT INTEND TO REPRESENT THROUGH THIS LIMITED WARRANTY AND ADJUSTMENT POLICY THAT TIRE FAILURES CAN OR CANNOT HAPPEN.

4. CTA'S OBLIGATIONS

Replacement of eligible tires will be made by the dealer where you purchased your vehicle or by an alternate Authorized Dealer. CTA will replace the tire pursuant to the terms of this Warranty. Tires that are replaced under this Warranty become the property of CTA.

5. OWNER'S OBLIGATIONS

To make an eligible claim under this Warranty, the owner must present a claim, with the tire to an Authorized Dealer. For the nearest Authorized Dealer, consult the Continental brand internet address(es), or the 800 telephone number(s) shown on the back of this Warranty.

Owner must present new vehicle registration form or new vehicle sales invoice indicating the date of purchase. Owner will be required to sign the CTA Limited Warranty Claim Form or dealer replacement sales receipt.

Owner is responsible for paying all applicable taxes charged by the servicing dealer and is also responsible for paying shipping, local tire-disposal fees and parts or service regardless of mileage or months of service. This includes payment for tire rotation, alignment, towing, road service, valve stems and tire repairs.

Owner is responsible for maintaining proper tire air pressure and for proper maintenance of the tire.

6. SAFETY WARNING:

Ignoring any of the safety and information contained in this warranty may result in tire failure, causing serious injury or death.

- **Tire failure due to underinflation /overloading.** Follow vehicle owner's manual or tire placard in vehicle for proper inflation and loading.
- **Explosion of tire/rim assembly due to improper tire mounting.** Tire mounting / demounting can be dangerous. It should be performed only by a trained tire specialist using proper tools and procedures. Prior to tire mounting/demounting, the Rubber Manufacturers Association (RMA) wall charts and manuals should be read to obtain the proper procedures. The failure to follow these procedures may result in faulty positioning of the tire and/or rim, which may cause the assembly to burst with force sufficient to cause injury or death.
- **Tire failure due to damage.** Inspect your tires frequently for scrapes, bulges, separations, cuts, snags and other damage from road hazards. Damage from impact can occur to the inner portions of your tire without being visible to the outside. If you suspect a tire has been damaged from striking anything unusual in the road, you must have the tire removed from the rim and inspected both inside and out by a trained tire specialist. Air loss or unusual tire wear can also be warning signs that a tire may have internal damage. If you notice these conditions, have your tire inspected by a trained individual.
- **Tire failure due to excessive tire spinning.** Avoid tire spinning. The centrifugal force generated by a free-spinning tire/rim assembly may cause a sudden tire explosion resulting in vehicle damage and/or serious injury or death. Never exceed 35 mph (55km/h) as indicated on your speedometer when your vehicle is stuck in snow,

CONTINENTAL TIRE

mud, or sand and your tire(s) is/ are spinning. Use a gentle backward and forward rocking motion to free your vehicle for continued driving. Never stand or permit anyone else to stand near or behind a tire spinning while attempting to push a vehicle that is stuck.

SELF SUPPORTING RUNFLAT (SSR) TIRE OWNERS:

CTA does not recommend any repair to or reuse of punctured Continental SSR tires.

Even a trained tire specialist may be unable to recognize internal structural damage to a Self Supporting Runflat (SSR) tire resulting from having been driven in an under inflated or zero inflation pressure condition. Such damage may not be visible on the surface of the inner liner or sidewall making it impossible to determine the tire suitability for repair or reuse. CTA does not recommend any repair to or reuse of Continental SSR tires. You may visit www.continentaltire.com and select Customer Care FAQ's to obtain additional SSR information.

TEMPORARY SPARE TIRE OWNERS:

CTA does not recommend any repair to or reuse of punctured Temporary Spare Tires.

CONTISEAL™ TIRE OWNERS:



A ContiSeal™ tire differs from a non-ContiSeal™ tire in that it has a sticky, viscous layer from shoulder to shoulder along the inner liner. This layer is an integral part of the ContiSeal™ tires. It is not designed or intended to act as a permanent puncture repair (See information below). If an object up to 3/16ths (5 mm) diameter penetrates the tread of the ContiSeal™ tire, this sticky, viscous layer is designed to surround and adhere to the puncturing object and prevent air loss from the tire by providing a near instantaneous seal. If the puncturing object becomes dislodged from the tire, the material is designed to seal most holes made by objects up to 3/16" (5 mm) diameter. While ContiSeal™ tires significantly reduce the incidence of flats they are not designed to be driven under inflated or in a flat condition. In all other aspects, ContiSeal™ tires perform exactly like non-ContiSeal™ tires. As with any tire, regularly inspect ContiSeal™ tires for evidence of cuts,

punctures, and loss of inflation pressure. At a minimum, ContiSeal™ tires should be inspected once or twice a month and always before a long trip. Punctures or damage not attended to promptly can result in loss of inflation pressure and/or damage to the tire. ContiSeal™ tires with cuts and punctures must be inspected by a trained tire specialist as soon as possible. The trained specialist, must inspect the tire carefully and, according to industry standards, to determine whether a permanent repair can be made or whether the tire must be removed from service and scrapped. A permanent repair will require removal of the tire from the rim and application of a repair method specifically approved for the ContiSeal™ tires.

ContiSeal™ tires are identified by a symbol on the tire sidewall.

CONTISILENT™ TIRE OWNERS:



ContiSilent™ tires are designed to reduce noise generated while driving. A ContiSilent™ tire is lined with a noise reducing foam

insert. It is not designed or intended to act as a puncture repair.

USING ContiSilent™ Tires

In aspects such as mounting, demounting, inflating and balancing, ContiSilent™ tires do not differ from non-ContiSilent™ tires. As with any tire, regularly inspect ContiSilent™ tires for evidence of cuts, punctures, and loss of inflation pressure. At a minimum, ContiSilent™ tires should be inspected once or twice a month and always before a long trip. Punctures or damage not attended to promptly can result in loss of inflation pressure and/or damage to the tire. ContiSilent™ tires with cuts and punctures must be inspected by a trained tire specialist as soon as possible. The trained tire specialist must inspect the tire carefully and, according to industry standards, determine whether a permanent repair can be made or whether the tire must be removed from service and scrapped.

A permanent repair will require removal of the tire from the rim and application of a repair method specifically approved for ContiSilent™ Tires. ContiSilent™ tires are identified by a symbol on the tire sidewall. ContiSilent™ tires and non-ContiSilent™ tires may be mixed on the same vehicle.

CONTINENTAL TIRE

In addition to the valuable warranty, safety and maintenance information you will find in this Warranty we encourage you to visit CTA websites at: www.continentaltire.com or www.continentaltire.ca for up-to-date changes and a Self-Help knowledge base with downloadable brochures (customer care link). Please also visit the Rubber Manufacturer Association (RMA) website at www.rma.org.

THIS LIMITED WARRANTY AND ADJUSTMENT POLICY IS NOT A WARRANTY THAT YOUR TIRE WILL NOT FAIL OR BECOME UNSERVICEABLE IF NEGLECTED OR MISTREATED.

FOR SERVICE ASSISTANCE OR INFORMATION

Contact any Authorized Dealer where you purchased the vehicle or the nearest Continental brand tire dealer. For the nearest Continental brand tire dealer, consult either the websites or the toll free Customer Relations number(s).

In the United States call 800-847-3349

In Canada, call 855-453-1962

Continental Tire the Americas, LLC
1830 McMillan Park Dr.
Fort Mill, SC 29707

Continental Tire Canada, Inc.
6110 Cantay Rd.
Mississauga, ON
L5R 3W5

FALKEN TIRE CORPORATION

FALKEN

MADE BY SUMITOMO RUBBER INDUSTRIES

Congratulations!

Your new vehicle is fitted with high performance and high quality Falken tires.

In order to guarantee that you receive the best performance and quality from your new Falken tires, we recommend that you read and follow all of the maintenance and safety tips provided in this document. We also suggest that you have your Falken tires periodically inspected and maintained by a qualified tire service professional.

A) TIRE CARE AND RECOMMENDATIONS

PROPER INFLATION AND FUEL ECONOMY

Ensure maximum performance and a long life from your tires by checking the air pressures at least once a month and set them to the vehicle manufacturer's recommended pressure(s) listed on the vehicle's tire placard or in your owner's manual. Always check and adjust your air pressure when your tires are cold, preferably first thing in the morning before driving. Never release air pressure from tires when they are hot. Wait until the tires cool down and recheck, adding air or releasing as required. Falken endorses the use of nitrogen in your tires because it helps your tires maintain optimal pressure for longer periods of time and reduces the amount of moisture inside of the tire and wheel assembly.

***Some plus size applications may require different air pressure(s) than what is listed on your vehicle's placard or owner's manual. In this case, please consult your tire dealer or Falken Tire for proper inflation pressure(s).**

TIRE INFLATION PRESSURE

Tires need to be properly inflated to effectively operate and perform as intended. Tires carry the weight of the vehicle, passengers, and cargo as well as bear the forces of braking, accelerating, and turning. The vehicle manufacturer sets the inflation pressures for the original equipment tires that are on your vehicle.

Driving with improperly inflated tires is dangerous. An under inflated tire will generate excessive heat build-up that will cause damage to the internal structure and inner liner of the tire. Besides tire damage, improper tire inflation pressures can also affect your vehicle's ride and handling, tire tread wear, and fuel economy. It is recommended to always keep all of your tires, including the spare, at the vehicle manufacturer's recommended inflation pressures and be sure to check the air pressure monthly and before going on long road trips or carrying extra weight in your vehicle.

Your vehicle's tire placard and/or owner's manual will list the cold inflation pressure(s) for your vehicle's original equipment tires, including the spare. The placard can be found on the driver's side door or door jamb area. If you have questions about understanding your vehicle's tire placard, please refer to your owner's manual or ask a qualified tire service professional.

Example of what your tire placard looks like:

TIRE AND LOADING INFORMATION		
SEATING CAPACITY : TOTAL 5 : FRONT 2 : REAR 3		
The combined weight of occupants and cargo should never exceed XXX kg or XXX lbs.		
ORIGINAL TIRE SIZE	COLD TIRE INFLATION PRESSURE	
P195/70R14	FRONT	200kPa, 29PSI
	REAR	200kPa, 29PSI
COMPACT SPARE TIRE	COLD TIRE INFLATION PRESSURE	
T125/70D15	420kPa, 60PSI	

SEE OWNER'S MANUAL FOR ADDITIONAL INFORMATION

CHECKING YOUR TIRE'S AIR PRESSURE

Checking your air pressure at least once a month is vital to help your tires perform properly and help you get the best gas mileage possible. Tires can lose up to 7 kPa (1 psi) per month under normal conditions and lose up to 7 kPa (1 PSI) per every 9°C (16°F) drop in temperature. Here are some simple steps on how to check the air pressures in your tires:

1. Remove the valve stem cap.
2. Place the end of the tire gauge firmly against the tire's valve stem.
3. Read the current pressure displayed on the gauge that is currently in the tire.
4. Increase pressure at this time (if needed) and recheck with your tire gauge.
5. Replace the valve stem cap.
6. Repeat until all of your tires have been checked and adjusted accordingly.

TIRE PRESSURE MONITORING SYSTEM (TPMS)



A tire pressure monitoring system (TPMS) is a safety system found in most vehicles manufactured after 2005. There are pressure sensing transmitters mounted inside of each tire that sends readings to the central computer (ECU) in your vehicle. The TPMS system will alert you when one or more of your tires are underinflated by 25% or more by turning on a warning light on your vehicle's dashboard or heads up display (HUD) screen. This means that one or more of your tires may have a low-pressure condition. Follow the instructions in your owner's manual.

ROTATION AND WEAR

Falken recommends rotating your tires at least every 8,000 km (5,000 miles) and periodically inspecting your tires to make sure they are free of road hazards (such as nails, screws, large wood splinters, etc.) that might penetrate your tires causing them to lose air pressure and to ensure they are wearing evenly. Common irregular wear patterns are: misalignment wear, where the tire shows excessive outer or inner tread wear. Tire sidewalls should also be inspected for cuts, snags, bruises, and weather cracking. If any of these noted conditions are present during inspection, we recommend returning to your servicing tire dealer to be corrected to ensure long tire life. *****Never include a temporary spare tire in your rotation pattern*****

Rotation patterns based on what type of drive your vehicle is:

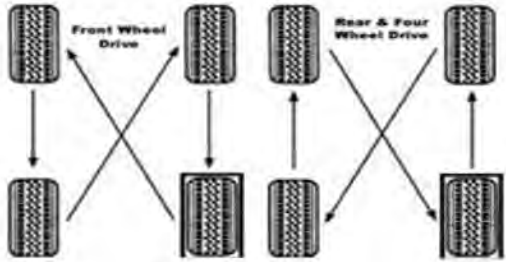

TIRE REPLACEMENT

Falken recommends replacing your tires when the tread wears down to the wear bars at 1.6 mm (2/32 of an inch), which are located across the tread in several locations around the tire. If only two tires are being replaced, the two new tires should always be installed on the rear of the vehicle to aid in preventing your vehicle from hydroplaning, even if your car is front wheel drive. It's always recommended to have your new tires balanced during installation, and alignment checked if the previous tires show and irregular wear. Tires that have been in use for 5 (five) years or more should continue to be inspected by a qualified tire specialist, at least annually. It is recommended that any tires 10 (ten) years old or older from the date of manufacture, including spare tires, be replaced with new tires as a precaution even if such tires appear serviceable and even if they have not reached the legal worn out limit at 1.6 mm (2/32 of an inch).

TIRE REPAIRS

In the event that you get a flat tire while driving, it is best to find a nearby, safe place to stop and install your spare tire or call a tow truck. The less distance that you drive on your low or flat tire, the better chances your tire has of being repairable. Once you are able to get to your local servicing tire dealer, have them dismount the tire from the rim and thoroughly inspect the inside of the tire. It is important to know the difference between a proper tire repair and an improper one because it can be critical to you and your vehicle's safety. An improper repair could pose a safety threat to you and your family and could also affect your tire's manufacturer warranty. Here are some tips in determining if your damaged tire can be properly repaired or not:

- Always have the tire removed from the wheel and inspected before any repair is performed.
- Tires with less than 1.6 mm (2/32 of an inch) of tread should NOT be repaired.
- Never repair a tire with a puncture larger than 6 mm (1/4 of an inch).
- Repairs should be limited to the tread area only.
- Repairs cannot overlap one another.
- A plug and patch or plug/patch combo should be used to effectively repair a tire puncture.
- If anything seems questionable at any time during the repair process, ask your service advisor for more details and/or call the tire manufacturer to make sure the tire's warranty isn't being voided.

TIRE MIX USAGE

WARNING!

Never mix tires of different size or construction and/or type on any axle. (Except for temporary use as a spare tire.) Always refer to the vehicle's owner manual for proper tire fitments.

TIRE SPEED RATINGS

Falken recommends replacing your tire(s) with the same speed rating as the original tires equipped on your vehicle.

It is okay to use a lower speed rated tire when using winter tires. However, speeds should be reduced to match the tires new “maximum” speed capability.

Any tire that is repaired, damaged, abused, altered from its original state or retreaded voids the speed rating on that particular tire and should be considered a non-speed rated tire.

WARNING!

Falken does not recommend the use of mixing different speed ratings on a vehicle. This can cause poor handling and unpredictable steering.

HIGH PERFORMANCE, LOW ASPECT RATIO TIRES

Various new vehicles come equipped with high performance and/or low aspect ratio tires from the factory. These tires generally provide increased vehicle handling characteristics, but may also have engineering performance trade-offs related with their designs. Low aspect ratio tires have reduced sidewall heights and may be more vulnerable to damage from road hazards, potholes, and other objects, like curbs. Your vehicle’s wheels are susceptible to these same dangers as well. Some vehicles may be originally equipped with high performance tires that are designed for warmer weather use reducing traction in colder, winter weather conditions. High performance tires also pose the possibility of wearing more quickly, giving a stiffer ride, and producing louder noise than standard all-season tires during operation. Refer to your vehicle owner’s manual, tire information placard,

WINTER TIRES

Falken recommends all four tires be replaced when replacing your original equipment tires and installing winter tires for the winter months.

WARNING!

Never use just two winter tires. It could lead to adverse handling, loss of control, which could cause serious injury or death.

STORING YOUR TIRES

When storing your tires for any extended period of time, be sure to thoroughly clean your tires with a tire brush, soap, and water to remove any dirt, salt, and brake dust from the tires. If you are storing your tires still mounted on the wheels, use a wheel brush and approved wheel cleaner to clean your wheels. Then dry the wheels and tires with a towel and allow them to fully dry. DO NOT apply any tire dressings while storing your tires. Tire compounds are made to resist weather cracking and ozone damage. Place each clean and dry tire in an airtight plastic bag and seal the bag with tape to help reduce oil evaporation. Store your tires out of direct sunlight and somewhere that is well shielded from the elements, like a climate-controlled room or dry basement. Storing the tires in a garage or shed usually exposes the tires to a wide range of temperatures as well as precipitation and humidity. Keep the tires away from sources that emit ozone like electric motors that use contact brushes, furnaces, sump pumps, etc. Although tires will still age regardless of how they are stored, these precautions will help slow the aging process and reduce the damage to your tires.

SPEED LIMITS

WARNING!

Operating your vehicle in excess of the posted speed limit or the maximum speed allotted by driving conditions has the potential to be dangerous. Higher driving speeds create excessive heat buildup in a tire, leading to a possible tire failure.

TIRE SPINNING

WARNING!

Spinning a tire to get a stuck vehicle out of mud, ice, snow, sand, or wet grass can be potentially dangerous. A spinning tire at a speedometer reading above 55 km/h (35 mph) can be capable of disintegrating a tire with explosive force. In some circumstances, a tire may be spinning at twice the speed displayed on the speedometer. This can cause serious injury or death to you, a passenger, or bystander. Never spin a tire above 55 km/h (35 mph).

B) LIMITED WARRANTY

This limited warranty applies to Falken brand Original Equipment Passenger Car, Temporary Spare, and Light Truck steel belted radial tires bearing the complete description and serial number required by the Department of Transportation (DOT). This warranty is effective only to tires for which claims are made within 5 (five) years of the date of production, based on the tire DOT serial number.

1. WHAT IS COVERED AND FOR HOW LONG

Falken tires that are originally equipped on this vehicle are warranted against any defects in the materials and workmanship for the usable life of the original tread. The limited warranty terminates at the flush appearance of the tread wear indicators at 1.6 mm (2/32 of an inch) remaining tread depth.

- A. Free Replacement If a tire becomes unserviceable due to such defect within the first 1.6 mm (2/32 of an inch) of tread wear, the tire will be replaced free of charge with the same or comparable Falken tire.
- B. Prorated Replacement After the first 1.6 mm (2/32 of an inch) of wear, a prorated adjustment credit will be given based on the percentage of remaining usable tread depth, down to the remaining 1.6 mm (2/32 of an inch) tread wear bar indicator. No credit is given if the tire is worn beyond the flush appearance of the tread wear bar indicator (less than 1.6 mm (2/32 of an inch) tread depth remaining).
- C. Out-of-Round / Out-of-Balance Replacement Tires that are deemed to be out-of-round or out-of-balance will be accepted for adjustment during the first 0.8 mm (1/32 of an inch) of the original tread depth and will be replaced free of charge with the same or similar Falken tires (no labor costs will be covered). A set of four (4) tires from the same vehicle will not be accepted for out-of-round or out-of-balance claims.

2. WHAT IS NOT COVERED BY THE WARRANTY

- A. Tires that becomes unserviceable due to road hazard damages (cuts, snags, punctures, bruises, impact breaks, etc.) improper repair technique or materials, improper inflation, overload, irregular wear, wheel imbalance, defective mechanical vehicle components (brakes, suspension, wheels, etc.) improper suspension alignment, accident, fire, chemical damage, damage from chain use, racing, off-road use, run flat, improper installation, vandalism, or abuse.
- B. Tires branded "NA" or a tire in which the DOT numbering has been removed.
- C. Tires presented for a warranty claim by someone other than by the original purchaser, or tires that were transferred to another vehicle from the vehicle in which the tires were originally installed.
- D. Tires having a failure or failures caused by a previous damages or repairs.
- E. The cost of tire repair or retreading is not covered by this warranty and will be the sole responsibility of the tire owner.

Possible NON Covered Reasons/Conditions due to:

Chipping/Chunking/Tearing	Puncture
Corrosion/Wreck	Racing or any Competition
Fire	Repair Failure
Impact Break or Concussions	Road Hazards
Improper Inflation Pressure	Sidewall Cut or Damage
Improper Mounting/Dismount	Theft or Vandalism
Mechanical Defects of the Vehicle	Tread Cuts
Misalignment	Wheel Imbalance
Misapplication	Willful Abuse
Overloading	

3. OWNER'S OBLIGATIONS

At least monthly, the vehicle owner(s) should check the tires' air pressure with a gauge and inflate to the recommended cold air pressure level listed on the driver's door placard. Do not rely on car servicers to perform the checks. The tires should be rotated at least every 8,000km (5,000 miles) or earlier if uneven wear is occurring, and proof of maintenance records should be kept. The owner(s) should have the tires rebalanced if vibration is experienced, and the vehicle's alignment should be checked if uneven or rapid wear is occurring, or when suggested by the vehicle's manufacturer.

All warranty claims must be presented to an authorized Falken dealer or participating car dealership. The owner(s) must present any supporting maintenance records and documentation necessary to help determine if the tire(s) in question are deemed covered by the limited warranty or not.

4. LEGAL RIGHTS

All implied warranties, including warranties of merchantability and fitness for a particular purpose shall be limited in duration to the above period. To the extent permitted by law, Falken Tire Corporation shall not be responsible for incidental or consequential damages, such as loss of use of the tire or the vehicle on which it is used, inconvenience, or commercial loss, some states do not allow limitations on how long an implied warranty lasts, or the exclusion or limitation of incidental or consequential damages, so the above limitations or exclusions may not apply to you. This warranty gives you specific legal rights and you may also have other rights, which vary from state to state. This is the only express warranty applicable to Falken brand tires and supersedes the terms of any previous warranty. Falken neither assumes nor authorizes anyone to make or assume for it any other warranty.

C) UNDERSTANDING YOUR TIRES

TIRE SPEED SYMBOLS

Tires that are speed-rated are identified by the following letter symbols: Q, S, T, U, H, V, W, Y, (Y), or (ZR). The Speed Rating's Symbol can be found as a part of the tire size designation (ex: 215/65HR16) or after the load index immediately following the tire size designation

(ex: 215/65R16 97H). The Speed Rating's Symbol indicates the maximum speed that a tire can handle when properly inflated and loaded.

Speed Symbol	Maximum Speed (KMH)	Maximum Speed (MPH)
Q	160	99
S	180	112
T	190	118
U	200	124
H	210	130
V	240	149
W	270	168
Y	300	186
(Y)	Above 300	Above 186
ZR**	Above 240	Above 149

NOTE: **For tires with speed symbols W and Y, ZR may or may not also appear within the size designation. For tires with a maximum speed above 186 MPH a ZR must appear in the size designation.

DATE OF TIRE MANUFACTURE

The date that a tire was manufactured can be determined by examining the last 4 digits of the 12 digit DOT serial code, which is found on at least one sidewall of a tire. For tires that were produced after the year 2000, the last 4 digits of the serial code will identify the week and the year that the tire was manufactured. If the last 4 digits in the DOT serial code were to read "3013" it would mean that the tire was manufactured the 30th week of 2013. If you are uncertain, check with a qualified tire service professional to be sure.



DOT Symbol And DOT Serial Code

The “DOT” symbol claims that the tire conforms to all applicable US Department of Transportation motor vehicle safety standards for tires. The identification/serial number follows the “DOT” symbol. Here is an example of a DOT serial code:

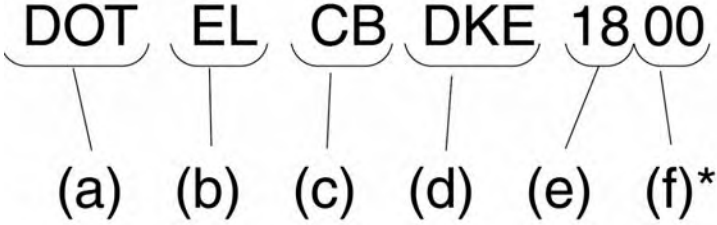

- | | |
|----------------------------|--|
| (a) DOT Symbol | (d) Tire Manufacturer’s Code |
| (b) Manufacture Plant Code | (e) Week of Production (01-52) |
| (c) Tire Size Code | (f) Year of Production (last two digits of year) |

TIRE SIDEWALL LABELING

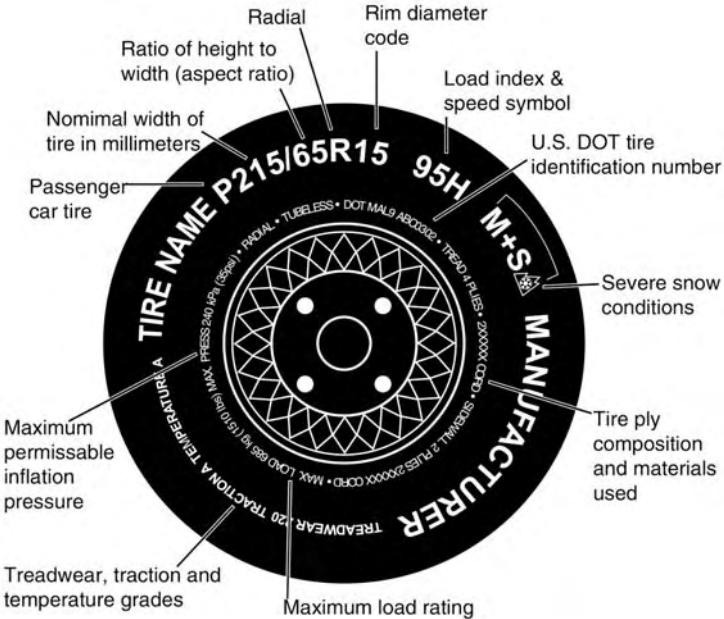

MAX LOAD AND INFLATION

The maximum load and inflation pressure is marked on the tire sidewall in English and metric units.

PLY COMPOSITION AND MATERIALS

The number of plies and their generic composition of cord materials in the sidewall and tread areas can be found on at least one sidewall of a tire.

RADIAL MARKING

A radial ply tire will have the word “radial” marked on at least one sidewall. An “R” found in the tire size marking also refers to the tire being a radial ply tire.

UNIFORM TIRE QUALITY GRADING SYSTEM (UTQG)

The Uniform Tire Quality Grading Standards (UTQG) were created to help you make an informed decision when purchasing passenger car tires by providing relative information about a tire’s treadwear, traction, and temperature characteristics. Here is a breakdown of the different categories that the UTQG grades:

TREAD WEAR

The tread wear grade is a comparative rating based on the wear rate of the tire when tested under controlled conditions on a specified government test course. For example, a tire graded **150** would wear one and a half (1½) times as well on the government course as a tire graded **100**. The relative performance of tires depends upon the actual conditions of their use, however, and may depart significantly from the norm due to variations in driving habits, service practices, and differences in road characteristics and climate.

TRACTION

The traction grades, from highest to lowest, are **AA, A, B** and **C**. Those grades represent the tire’s ability to stop on wet pavement as measured under controlled conditions on specific government test surfaces of asphalt and concrete. A tire marked **C** may have poor traction performance.

WARNING!

The traction grades assigned to this tire is based on straight ahead braking traction tests, and does not include acceleration, cornering, hydroplaning, or peak traction characteristics.

TEMPERATURE

The temperature grades are **A** (the highest), **B**, and **C**, representing the tire's resistance to the generation of heat and its ability to dissipate heat when tested under controlled conditions or on a specified indoor laboratory test wheel. Sustained high temperature can cause the material of the tire to degenerate and reduce in tire life, and excessive temperature can lead to sudden tire failure. The grade **C** corresponds to a level of performance which all passenger car tires must meet under the Federal Motor Vehicle Safety Standard No.109. Grades **B** and **A** represent higher levels of performance on the laboratory test wheel than minimum required by law.

WARNING!

The temperature grade for each tire is established for a tire that is properly inflated and not overloaded. Excessive speed, under-inflation, or excessive loading either separately or in combination, can cause heat buildup and possible tire failure.

E) Tire Maintenance Record

Front kPa (PSI)_____

Rear kPa (PSI)_____

MAINTENANCE RECORD						
Mileage	Date	Retailer	Inspection	Rotation	Balance	Alignment

Tire Manufacturer Contact Information

Country	Company	Address	Telephone Number
ARGENTINA	Geveco S.A.	Av. Triunvirato 3460, Capital Federal 1427, Buenos Aires, ARGENTINA	+54114 555 4050
AUSTRALIA	Sumitomo Rubber Australia Pty Ltd	32 Riverside Road, Chipping Norton, NSW. 2170, AUSTRALIA	+61 2 8774 2905
BAHRAIN	International Tire Centre	P.O. BOX 47036, Doha, QATAR	+974 40157001
BRAZIL	Sumitomo Rubber Do Brasil Ltda.	Rua Euripedes Garcez do Nascimento, 523- Ahu, Curitiba Parana, CEP: 80540-280, BRAZIL	+55 41 3060 9250
CANADA	Sumitomo Rubber North America, Inc.	8656 Haven Avenue, Rancho Cucamonga, CA 91730, USA	+1 800 723 2553
CHILE	Neumaticos del Pacifico	Carlos Salas Herrera N°4165 Conchali, Santiago, CHILE	+562 734 4900
CHINA	Sumitomo Rubber (China), Ltd.	Riverside Industrial Park, Jiangsu Province Changshu Economic Development Zone, P.R. CHINA	+86 512 5269 0502
COLOMBIA	Com. De Liantas Unidas	Zona Franca del Pacifico, Carretera Yumbo - Aeropuerto Km. 6, COLUMBIA	+57 2 2802000
COSTA RICA	Fanast	Contiguo al parqueo de Hipermás, San Sebastian - P.O. Box 912-1000 San José, COSTA RICA	+506 2227 1111
ECUADOR	Sumitomo Corp. Del Ecuador	Av. Amazonas 4080 Y Naciones Unidas, Edif. Puerta Del Sol Torre A - Piso 7, ECUADOR	+593 22261751
EGYPT	BARAKAT BROTHERS COMPANY	6ST Toot Ankh Amoon, Samoha, Alexandria, EGYPT	+20 2 034205353
FRANCE	Falken Tyre Europe GmbH	Berliner Strasse 74-76, 63065 Offenbach, GERMANY	+49 69 247 5252 10
GERMANY	Falken Tyre Europe GmbH	Berliner Strasse 74-76, 63065 Offenbach, GERMANY	+49 69 247 5252 10
GREAT BRITAIN	Falken Tyre Europe GmbH	Berliner Strasse 74-76, 63065 Offenbach, GERMANY	+49 69 247 5252 10

Country	Company	Address	Telephone Number
IRAN	Nagina Marketing FZCO	P.O. BOX 2131, Dubai, UAE	+98 971 4 3327701
ISRAEL	Autoluxe Tires (Israel) LTD.	25 Hamelacha Street, Park Afeg, Rosh Haayin, 48091, ISRAEL	+972 3 90296
IRAQ	DIJLAT AL-KHAIR for General trading Ltd.	Khanaqa market (commercial center), 1st floor, flat No.2, Sulaymaniyah, IRAQ	+964 7901946744
ITALY	Falken Tyre Europe GmbH	Berliner Strasse 74-76, 63065 Offenbach, GERMANY	+49 69 247 5252 10
JAPAN	Sumitomo Rubber Industry, LTD	3-6-9 Wakinohama-cho, Chuo-ku, Kobe, Hyogo 651-0072, JAPAN	+81 78 265 5626
JORDAN	Jarash Trading Co.	P.O. BOX 621100, AMMAN 11162, JORDAN	+962 6 4637290
KUWAIT	Al Ghannam Tires Center CO. WLL	P.O. BOX 26191, SAFAT, 13122, KUWAIT	+965 24830915
LEBANON	PROLAC	Halat Naher Ibrahim, Beirut, LEBANON	+961 9 478170
LIBYA	AL SUHOUL	PO Box 70786 Tripoli, LIBYA	+218 21 360 61 88
MEXICO	TBC de Mexico, S.A. d C.V.	Eje 114 No.150, Zona Industrial San Luis Potosi, S.L.P. C.P. 78395, MEXICO	+1 800 288 5526
MOROCCO	Pneumatique Ennor	DERB MOULAY CHRIF - N 176/178 - BD, IBNOU EL OUANAN - HAY MOHAMMADI, CASABLANCA, MOROCCO	+212 522628303
NEW ZEALAND	O.T.R. International (NZ) Ltd	415 East Tamaki Road, PO Box 51110 Pakuranga, Auckland, NEW ZEALAND	+64 09 272 1830
OMAN	Oman Gulf Enterprises	P.O. BOX 421, POSTAL CODE : 118, Al Hamriya, SULTANATE OF OMAN	+968 24787815
PERU	Lima Caucho S.A.	Carretera Central N 349 Km.1 Santa Anita, Lima 43, PERU	+51 1 317 0500

FALKEN TIRE CORPORATION

Country	Company	Address	Telephone Number
POLAND	Falken Tyre Europe GmbH	Berliner Strasse 74-76, 63065 Offenbach, GERMANY	+49 69 247 5252 10
QATAR	International Tire Centre	P.O. BOX 51, DOHA, QATAR	+974 40157001
SAUDI ARABIA	Al Howail Group	P.O. Box 7580, Damman 31472, SAUDI ARABIA	+966 3 8091796
SOUTH AFRICA	Stamford Tyres (Africa) (Pty) Ltd	8 Ferrule Avenue, Montague Gardens, 7441 Cape Town, SOUTH AFRICA	+27 21 790 1302
SPAIN	Falken Tyre Europe GmbH	Berliner Strasse 74-76, 63065 Offenbach, GERMANY	+49 69 247 5252 10
TURKEY	Abudulkadir Özcan Otomoti	Kazım karabekir Cad. Özcan Plaza No:124, 06060 Dışkapı, Ankara, TURKEY	+90 0312 3093030
UAE	Wolfe Tyres Batteries and Accessories LLC	P.O. BOX 325, AL Gurg Tower No:1, Baniyas Road, Deira Creek, Dubai- UAE +	+971 4 3378731
UNITED STATES	Sumitomo Rubber North America, Inc.	8656 Haven Avenue, Rancho Cucamonga, CA 91730, USA	+1 800 723 2553
YEMEN	Bin Sharaf Tire Trading	Ring Road, Sana'a, REPUBLIC OF YEMEN	+967 1265300

GENERAL TIRE

LIMITED WARRANTY FOR ORIGINAL EQUIPMENT PASSENGER CAR AND LIGHT TRUCK TIRES (Including SPECIAL SPARE Tires)

This booklet also includes important safety warnings.

ELIGIBILITY

This Limited Warranty and Adjustment Policy applies to the original owner of new General brand passenger and light truck (LT) tires that are the new vehicle original equipment tires bearing the General brand name and D.O.T. Tire Identification, operated in normal service, and used on the same vehicle on which they were originally installed according to the vehicle manufacturer's recommendations.

Tire(s) on any vehicle registered and normally operated outside the United States and Canada are excluded from eligibility under this Limited Warranty and Adjustment Policy.

WHAT IS THE ADJUSTMENT POLICY AND HOW LONG IS IT APPLICABLE?

BASIC COVERAGE:

Eligible Tires are covered by this Limited Warranty and Adjustment Policy for a maximum of 72 months from the date of purchase, determined by the new vehicle registration date or new vehicle sales invoice showing date of purchase.

Where to Go for Warranty replacement: Contact the vehicle dealer from where you purchased the vehicle to determine the eligible warranty coverage for your tires and where to proceed from there.

Free Replacement Period: If an eligible General brand passenger or light truck tire becomes unserviceable from a condition other than those listed under Section 3 during the first 12 months or first 2/32nds of an inch (1.6 mm) of tread wear (whichever comes first) it will be replaced with a comparable new General brand tire FREE OF CHARGE, including mounting and balancing. Owner pays all applicable taxes.

Temporary Spare Tires: This Policy also extends to the original owner of the General brand Temporary Spare Tire that was originally equipped by the vehicle manufacturer as a temporary spare tire bearing a General

GENERAL TIRE

D.O.T. serial number. An eligible Temporary Spare Tire under this Policy must have been operated in normal service, used on the same vehicle on which they were originally installed according to the vehicle manufacturer's recommendations,

This Policy is for a maximum period of 72 months from date of purchase, determined by the new vehicle registration date or new vehicle sales invoice showing date purchased.

If a Temporary Spare Tire becomes unserviceable from a condition other than those listed in Section 3, during the first 1/32 nd (0.8 mm) of tread wear, then it will be replaced with a comparable new General brand Temporary Spare Tire FREE OF CHARGE, including mounting and balancing. The owner pays all applicable taxes.

After this "Free Replacement Policy" for your Temporary Spare Tire expires, no adjustment will be made.

After the Free Replacement Period:

The tire (except temporary spare tire) may still be eligible for a pro rated replacement for 72 months from date of original purchase until the tread is worn down to the tread wear indicators (2/32 nds of an inch or 1.6 mm of tread remaining.) If an eligible tire becomes unserviceable under the stipulations of this Limited Warranty and Adjustment policy it will be replaced charging the owner a pro-rated amount. Owner pays all applicable taxes (including F.E.T.), mounting and balancing charges.

The replacement tire price will be determined by multiplying the percentage of the usable tread worn by the Dealers Selling Price (excluding all applicable taxes) at the time of the adjustment. The usable tread is the original tread down to the tread wear indicators (2/32 nds of an inch or 1.6 mm of tread remaining.)

WHAT IS NOT COVERED BY THIS LIMITED WARRANTY

THE FOLLOWING ARE NOT COVERED:

- **Road Hazard:** Any General tire with road hazard damage. This includes, but is not limited to: cuts, snags, punctures, bruises, and impact breaks.
- **Ride/Vibration:** Any ride/vibration complaint after the first 2/32 nds (1.6 mm) of an inch of tread wear or 12 months of service, whichever comes first.

- **Repairs:** If a tire is returned under complaint and the reason for the tire's disablement is in any way associated with a repair, or with the situation that led to the repair, the manufacturer's warranty is invalidated.
- **Mileage:** Tread wear out up to a predetermined mileage is not covered under this policy.
- **Improper operation or maintenance:** This includes, but is not limited to, effects caused by:
 - A. **Improper tire inflation and/or improper load/speed practices:**
These practices can cause excessive operational temperatures and stresses that exceed the tire's capabilities.
 - B. **Improper or insufficient tire rotation**
 - C. **Improper vehicle alignment**
 - D. **Damage due to:**
 - Rim irregularities or rim damage
 - Snow chains
 - Vehicle mechanical problems, including brake problems, and vehicle wheel alignment.
 - Extreme temperature exposure
 - Negligent and abusive driving such as tire spinning, or racing;
 - Improper tire storage
 - Automotive accident
 - Chemical corrosion or fire
 - Use contrary to the vehicle manufacturer's tire recommendations.
 - Misuse or misapplication
- **Improper Mounting or Demounting**
- **Alteration:** such as, but not limited to, adding a white inlay on blackwall, tread regrooving, tire truing or siping, or adding sealant materials to the tire.
- **Weather checking/cracking:** Not covered after 48 months from the date of purchase.
- **Failure to observe safety and maintenance precautions set forth in the Safety Warning Section.**

GENERAL TIRE

ATTENTION AUTHORIZED DEALERS:

CTNA RESERVES THE RIGHT TO THE FINAL INSPECTION DECISION FOR ALL RETURNED TIRES ON CONDITIONS UNDER THIS SECTION.

THIS LIMITED WARRANTY AND POLICY IS MADE IN LIEU OF ALL OTHER WARRANTIES, EXPRESS OR IMPLIED, INCLUDING, BUT NOT LIMITED TO, WARRANTIES OF MERCHANTABILITY OR FITNESS FOR A PARTICULAR PURPOSE. CTNA EXPRESSLY DISCLAIMS ALL IMPLIED WARRANTIES, INCLUDING, BUT NOT LIMITED TO, WARRANTIES OF MERCHANTABILITY OR FITNESS FOR A PARTICULAR PURPOSE. SOME U.S. STATES AND/OR CANADIAN PROVINCES DO NOT PERMIT SUCH A LIMITATION; FOR THOSE U.S. STATES AND/OR CANADIAN PROVINCES, ANY IMPLIED WARRANTIES, INCLUDING, BUT NOT LIMITED TO, ANY WARRANTY OF MERCHANTABILITY OR FITNESS FOR A PARTICULAR PURPOSE, ARE LIMITED TO THE DURATION OF THIS WRITTEN LIMITED WARRANTY. SOME U.S. STATES AND/OR CANADIAN PROVINCES DO NOT ALLOW LIMITATIONS ON THE DURATION OF AN IMPLIED WARRANTY, SO THE ABOVE MAY NOT APPLY TO YOU.

TO THE EXTENT PERMITTED BY LAW, CTNA DISCLAIMS LIABILITY FOR ALL CONSEQUENTIAL AND INCIDENTAL DAMAGES. THE REMEDIES SET FORTH IN THIS LIMITED WARRANTY ARE THE SOLE AND EXCLUSIVE REMEDIES FOR BREACH OF WARRANTY. SOME U.S. STATES AND/OR CANADIAN PROVINCES DO NOT ALLOW THE EXCLUSION OR LIMITATION OF INCIDENTAL OR CONSEQUENTIAL DAMAGES, SO THE ABOVE LIMITATION OR EXCLUSION MAY NOT APPLY TO YOU. THIS WARRANTY GIVES YOU SPECIFIC LEGAL RIGHTS, AND YOU MAY ALSO HAVE OTHER RIGHTS WHICH VARY FROM U.S. STATE TO STATE AND/OR CANADIAN PROVINCE TO PROVINCE.

THIS IS THE ONLY EXPRESS WARRANTY MADE BY CTNA. NO CTNA EMPLOYEE, RETAILER, OR DEALER HAS THE AUTHORITY TO MAKE ANY WARRANTY, REPRESENTATION, PROMISE OR AGREEMENT ON BEHALF OF CTNA EXCEPT AS EXPRESSLY WRITTEN IN THIS LIMITED WARRANTY AND ADJUSTMENT POLICY.

IN OBSERVANCE OF U.S. FEDERAL LAW, THIS LIMITED WARRANTY AND ADJUSTMENT POLICY HAS BEEN DESIGNATED A "LIMITED WARRANTY". CTNA DOES NOT INTEND TO REPRESENT THROUGH THIS LIMITED WARRANTY AND ADJUSTMENT POLICY THAT TIRE FAILURES CAN OR CANNOT HAPPEN.

CTNA'S OBLIGATIONS

Contact the vehicle dealer from where you purchased the vehicle. Your tires may be covered under the vehicle manufacturer's limited warranty. If not, this CTNA Policy applies and replacement of Eligible Tires can be made by any vehicle dealer authorized to handle General brand tire adjustments or a General brand authorized dealer ("Authorized Dealer"). CTNA will replace the tire pursuant to the terms of this Limited Warranty and Adjustment Policy. Tires that are replaced under an adjustment basis under this Limited Warranty and Adjustment Policy become the property of CTNA.

OWNER'S OBLIGATIONS

To make an eligible claim under this Limited Warranty and Adjustment Policy, the owner must present a claim with the tire to an Authorized Dealer. For the nearest Authorized Dealer, consult the Yellow Pages, the General brand internet address, or the 800 telephone numbers shown on the back of this Limited Warranty and Adjustment Policy. Owner must present new vehicle registration form or new vehicle sales invoice indicating the date of purchase. Owner will be required to sign the CTNA Limited Warranty Claim Form or dealer replacement sales receipt.

Owner is responsible for paying all applicable taxes set forth under this Limited Warranty and Adjustment Policy. Owner is also responsible for paying local tire disposal fees and any parts or service regardless of mileage or months of service. This includes payment for tire rotation, alignment, towing, road service, valve stems and tire repairs. Owner is responsible for maintaining proper tire air pressure and for proper maintenance of the tire.

GENERAL TIRE

SAFETY WARNING:

Ignoring any of the safety and information contained in this limited warranty and Adjustment Policy may result in tire failure, causing serious injury or death.

- **Tire failure due to underinflation/overloading.** Follow vehicle owner's manual or tire placard in vehicle for proper inflation and loading.
- **Explosion of tire/rim assembly due to improper tire mounting.** Tire mounting / demounting can be dangerous. It should be performed only by a trained tire specialist using proper tools and procedures. Prior to tire mounting/demounting, the Rubber Manufacturers Association (RMA) wall charts and manuals should be read to obtain the proper procedures. The failure to follow these procedures may result in faulty positioning of the tire and/or rim, which may cause the assembly to burst with force sufficient to cause injury or death.
- **Tire failure due to damage.** Inspect your tires frequently for scrapes, bulges, separations, cuts, snags and other damage from road hazards. Damage from impact can occur to the inner portions of your tire without being visible to the outside. If you suspect a tire has been damaged from striking anything unusual in the road, you must have the tire removed from the rim and inspected both inside and out by a trained tire specialist. Air loss or unusual tire wear can also be warning signs that a tire may have internal damage. If you notice these conditions, have your tire inspected by a trained individual.
- **Tire failure due to excessive tire spinning.** Avoid tire spinning. The centrifugal force generated by a free-spinning tire/rim assembly may cause a sudden tire explosion resulting in vehicle damage and/or serious injury or death. Never exceed 35 mph (55 km/h) as indicated on your speedometer when your vehicle is stuck in snow, mud, or sand and your tire(s) is/are spinning. Use a gentle backward and forward rocking motion to free your vehicle for continued driving. Never stand or permit anyone else to stand near or behind a tire spinning while attempting to push a vehicle that is stuck.

TEMPORARY SPARE TIRE OWNERS:

CTNA does not recommend any repair to or reuse of punctured Temporary Spare Tires.

In addition to the valuable warranty, safety and maintenance information you will find in this Limited Warranty and Adjustment Policy we encourage you to visit General Tire Brand websites at:

www.generaltire.com or (www.generaltire.ca) for up-to-date changes and a Self-Help knowledge base with downloadable brochures (customer care link). Please also visit the Rubber Manufacturer Association (RMA) website at www.rma.org.

THIS LIMITED WARRANTY AND ADJUSTMENT POLICY IS NOT A WARRANTY THAT YOUR TIRE WILL NOT FAIL OR BECOME UNSERVICEABLE IF NEGLECTED OR MISTREATED.

FOR SERVICE ASSISTANCE OR INFORMATION

First, contact the nearest General brand tire dealer. For the nearest General brand tire dealer, consult the Yellow Pages or, if for any reason local service or information is not available, call one of General brand toll-free Customer Relations numbers:

In the United States call 1-800-847-3349

In Canada, call 1-800-461-1776

CTNA, Inc. 1830 McMillan Park Dr. Fort Mill, SC 29707

CT Canada Inc. 6110 Cantay Rd. Mississauga, ON L5R 3W5

GOODYEAR DUNLOP TIRES

HIGHWAY AUTO AND LIGHT TRUCK TIRE WARRANTY AND ADJUSTMENT POLICY (EXCLUDES GOODYEAR® UNISTEEL® RADIAL LIGHT TRUCK TIRES)

WHO IS ELIGIBLE?

You are eligible for the benefits of this Limited Warranty if you meet all the following criteria:

- You are the owner or authorized agent of the owner of new Goodyear or Dunlop® highway auto or light truck tires supplied as Original Equipment on your vehicle.
- Your tires bear Department of Transportation prescribed tire identification numbers.
- Your tires have been used only on the vehicle on which they were originally installed according to the vehicle manufacturer's or Goodyear's recommendations.
- Your tires were purchased on or after March 1, 2014.

Light truck tires are defined as all tires identified with the "LT" designation in the sidewall stamping.

WHAT IS COVERED AND FOR HOW LONG?

FREE TIRE REPLACEMENT

Any new Goodyear or Dunlop highway radial auto or radial light truck tire, covered by this policy, removed from service due to a covered warranty condition during the first 2/32" of usable tread or twelve months from date of purchase, whichever comes first, will be replaced with a comparable new Goodyear or Dunlop tire at no charge, including mounting and balancing. (Without proof of purchase the date of manufacture will be used to determine eligibility.)

GOODYEAR DUNLOP TIRES

ALL OTHER HIGHWAY AUTO OR LIGHT TRUCK TIRES

Any new Goodyear or Dunlop highway auto or light truck tire, other than radial auto or radial light truck tires, removed from service due to a covered warranty condition during the first 1/32" of usable tread will be replaced with a comparable new Goodyear or Dunlop tire at no charge, including mounting and balancing.

TEMPORARY SPARE TIRES

Any Goodyear or Dunlop temporary spare tire removed from service due to a covered warranty condition during the first 50% of usable tread wear (1/32") will be replaced with a comparable new Goodyear or Dunlop temporary spare tire at no charge, including mounting.

PRORATED ADJUSTMENT

Tires not eligible for free replacement that are removed from service due to a covered warranty condition will be replaced with a comparable new Goodyear or Dunlop tire on a prorated basis for up to six (6) years from the date of original new tire purchase or when the treadwear indicators become visible (worn to 2/32"), whichever occurs first. (Without proof of purchase the date of manufacture will be used to determine eligibility.)

HOW WILL PRORATED CHARGES BE CALCULATED?

Replacement price will be calculated by multiplying the tire's advertised retail selling price at the time of adjustment by the percentage of usable original tread that has been worn off. You pay for mounting and balancing, and an amount equal to the current Federal Excise Tax (F.E.T. – U.S. only) and any other applicable taxes and government-mandated charges.

EXAMPLE: If your disabled tire had an original 8/32 of usable tread wear and is worn to 4/32 usable tread remaining, you have used 50% and therefore must pay 50% of the advertised retail selling price of the comparable tire.

In addition, you must pay an amount equal to the full current Federal Excise Tax (U.S. only) or any other applicable taxes and government-mandated charges for the comparable new replacement tire at the time of adjustment. If the price of the new comparable tire is \$130.00, the cost to you would be \$65.00 plus F.E.T. (U.S. only) plus any other applicable taxes and government-mandated charges.

WHAT IS A COMPARABLE TIRE?

A “comparable” new Goodyear or Dunlop tire will be the same brand tire and may be either the same line of tire or, in the event that the tire is not available, the same brand tire with the same basic construction and similar performance attributes with a different sidewall or tread configuration. If a higher priced tire is accepted as replacement, the difference in price will be at an additional charge to you. Any replacement tire provided pursuant to this warranty will be covered by the warranty in effect at the time of replacement.

ADDITIONAL PROVISIONS

A tire has delivered its full original tread life and the coverage of this limited warranty ends when the tread wear indicators become visible (worn to 2/32”) or six (6) years from the date of new tire purchase, whichever occurs first. (Without proof of purchase the date of manufacture will be used to determine eligibility.)

LIMITATIONS

This limited warranty is applicable only in the United States and Canada.

WHAT IS NOT COVERED BY THIS WARRANTY?

This limited warranty does not cover the following:

- Tires submitted for ride disturbance complaints that are worn beyond the first two thirty-seconds of an inch (2/32”) tread depth or tires submitted for ride disturbance due to damaged wheels or any vehicle condition.
- Goodyear does not warrant or give credit in any adjustment transaction for any kind of material added to a tire (e.g., tire fillers, sealants, balancing substances) after the tire leaves a factory producing Goodyear or Dunlop tires, nor will it adjust any tire that has failed as a result of adding such material.
- Irregular wear or damage due to mechanical condition of the vehicle, improper inflation, overloading, high speed spin-up, misapplication, misuse, negligence, racing, use of tire chains, improper mounting or demounting, improper repair, wreck, collision or fire.
- Road hazards (includes, but is not limited to, punctures, cuts, snags, impact breaks, etc.).

GOODYEAR DUNLOP TIRES

- Any tire that, after leaving a factory producing Goodyear or Dunlop tires, has been intentionally altered to change its appearance (e.g., white inlay on a black tire or regrooved).
- Tires with weather-cracking that were purchased more than four (4) years prior to presentation for adjustment or, if purchase date cannot be verified, manufactured more than four years prior to presentation for adjustment.
- Temporary spare tires used on vehicles used in racing and on passenger cars in special applications such as police pursuit service.
- Goodyear Unisteel Commercial Radial Light Truck Tires.
- Tires removed from service due to improper repairs.
- Tires supplied as Original Equipment are not eligible for any tread life warranty consideration.
- Cosmetic weather checking
- Low tire pressure-monitoring system – refer to vehicle manufacturer’s warranty.
- Ultra High-Performance summer tires are not recommended for winter use, and tread or shoulder cracking on those tires resulting from winter use will not be covered under our warranty.

WHAT ARE YOUR LEGAL RIGHTS?

No Representative or Dealer has authority to make any representation, promise or agreement on behalf of Goodyear, except as stated herein. Any tire, no matter how well constructed, may fail in service or otherwise become unserviceable due to conditions beyond the control of the manufacturer. Under no circumstances is this warranty a representation that a tire failure cannot occur.

DISCLAIMER: THIS WARRANTY IS IN LIEU OF, AND GOODYEAR HEREBY DISCLAIMS, ANY AND ALL OTHER WARRANTIES AND REPRESENTATIONS, EXPRESS OR IMPLIED, INCLUDING WITHOUT LIMITATION ANY WARRANTY OF MERCHANTABILITY OR FITNESS FOR A PARTICULAR PURPOSE, AND NO OTHER WARRANTY OR REPRESENTATION OF ANY KIND IS MADE BY GOODYEAR OR SHALL BE IMPLIED BY LAW.

LIMITATION OF DAMAGES: IN NO EVENT AND UNDER NO CIRCUMSTANCE SHALL GOODYEAR BE LIABLE TO THE BUYER FOR ANY INDIRECT, SPECIAL, INCIDENTAL, CONSEQUENTIAL, LOST PROFIT, LOSS OF BUSINESS, LOSS OF GOODWILL OR REPUTATION, PUNITIVE OR OTHER DAMAGE, COST (INCLUDING FOR REPLACEMENT TRANSPORTATION), EXPENSE OR LOSS OF ANY KIND. SOME STATES AND PROVINCES DO NOT ALLOW THE EXCLUSION OR LIMITATION OF INCIDENTAL OR CONSEQUENTIAL DAMAGES, SO THE ABOVE LIMITATION OR EXCLUSION MAY NOT APPLY TO YOU.

This warranty gives you specific legal rights and you may also have other rights that vary from state to state or province to province.

HOW DO YOU OBTAIN AN ADJUSTMENT?

1. You must present the tire to be adjusted to an authorized Goodyear or Dunlop service facility. Tires replaced on an adjustment basis become the property of The Goodyear Tire & Rubber Company or Goodyear Canada Inc.
2. You must pay for taxes and any additional services you order at the time of adjustment plus any additional service that may be unique to your application, e.g., Tire Pressure Monitoring System.
3. You must submit your claim on an approved claim form supplied by an authorized Goodyear or Dunlop service facility. The form must be filled out completely and signed, where you the owner or your authorized agent presented the tire for adjustment. You must go to an authorized Goodyear or Dunlop outlet for replacement tires and all warranty service.

SAFETY WARNINGS

Property damage, serious injury or death may result from:

- **TIRE FAILURE DUE TO UNDERINFLATION/OVERLOADING/MISAPPLICATION.** Follow the vehicle owner's manual or tire placard in vehicle.
- **TIRE FAILURE DUE TO IMPACT DAMAGE/IMPROPER MAINTENANCE.** Tires should be inspected regularly by a qualified technician for signs of damage, such as punctures or impacts.

GOODYEAR DUNLOP TIRES

- **TIRE FAILURE DUE TO IMPROPER REPAIRS.** See Rubber Manufacturers Association (RMA) established repair procedures at www.rma.org and/or go to www.goodyear.com for information on proper repair procedures.
- **EXPLOSION OF TIRE/RIM ASSEMBLY DUE TO IMPROPER MOUNTING.** Only specially trained persons should mount tires.
- **FAILURE TO MOUNT RADIAL TIRES ON APPROVED RIMS.**
- **FAILURE TO DEFLATE SINGLE OR DUAL ASSEMBLIES COMPLETELY BEFORE DEMOUNTING.**
- **TIRE SPINNING.** On slippery surfaces such as snow, mud, ice, etc., do not spin tires in excess of 35 mph (55 kph), as indicated on the speedometer.
- **EXCESSIVE WHEEL SPINNING.** This can also result in tire disintegration or axle failure.

WARNING!

Vehicle handling, traction, ride comfort and other performance parameters may be significantly affected by a change in tire size or type. Before replacing tires, always consult and follow the vehicle owner's manual because some vehicle manufacturers prohibit changing tire size. When selecting tires that are different from the original equipment size make certain:

1. The tires have adequate load-carrying capacity based on the vehicle placard,
2. The tires have sufficient inflation pressure to carry the load and
3. There is proper clearance with no interference points between the tire and vehicle.

The consumer must be aware to always drive safely and obey all traffic laws. Avoid sudden, sharp turns or aggressive lane changes. Failure to follow any of these warnings may result in loss of control of the vehicle, leading to an accident and serious injury or death.

TIRE CARE AND MAINTENANCE GUIDE

The easiest way to help ensure satisfactory mileage and performance from your Goodyear or Dunlop tires is to give them a simple but frequent (at least monthly) inspection for proper inflation, even tread wear and the presence of any damage.

DO MAINTAIN PROPER INFLATION PRESSURE IN YOUR TIRES

Proper inflation pressure is necessary for optimum tire performance, safety and fuel economy. Check inflation pressures at least once a month and before long trips. Use an accurate tire pressure gauge. Always check pressures when the tires are cold (when the vehicle has been driven less than one mile). If you must check inflation when the tires are hot, add 4 psi (27 kPa) to the recommended cold inflation pressure. It is difficult to tell just by looking at radial tires whether they are underinflated.*

Furthermore, when operating a vehicle equipped with radial tires, it is difficult to notice when a tire has gone flat or nearly flat since the “feel” of the vehicle does not change significantly.

***Evidence of air loss or repeated underinflation always requires expert inspection to determine the source of leakage and tire removal to determine repairability.** To avoid injury, NEVER attempt to reinflate a tire that has been run severely underinflated. Progressive air loss may result from punctures, cuts, curbing, impacts or partial bead unseating. Some fitment causes for air loss are (1) incomplete bead seating, (2) bead tearing caused by a machine tool due to insufficient lubrication or improper adjustment. Leaking valve core or rubber valve components should be replaced when problems are detected and whenever tires are replaced.

Always maintain inflation pressure at the level recommended by the vehicle manufacturer as shown on the vehicle placard, vehicle certification label or in the vehicle owner’s manual:

Under inflation is the leading cause of tire failure and may result in severe cracking, component separation or “blowout.” It reduces tire load capacity, allows excessive sidewall flexing and increases rolling resistance, resulting in heat and mechanical damage. Maintaining proper inflation pressure is the single most important thing you can do to promote tire durability and maximize tread life.

Over inflation increases stiffness, which may deteriorate ride and generate unwanted vibration. Over inflation also increases the chances of impact damage.

DON'T OVERLOAD YOUR VEHICLE

Check your vehicle owner's manual to determine the load limits. Overloading your vehicle places stress on your tires and other critical vehicle components. Overloading a vehicle can cause poor handling or increased fuel consumption and may cause tire failure. Overloading your tires can result in severe cracking, component separation or "blowout."

Never fit your vehicle with new tires that have less load capacity than shown on the vehicle tire placard and remember that optimum rim width is important for proper tire load distribution and function. The maximum load capacity stamped on the sidewalls of P-Metric & European Metric tires is reduced by 10% when used on a light truck, utility vehicle or trailer. Never fit P-Metric or European Metric tires to light trucks that specify LT-type replacement tires.

DON'T SPIN YOUR TIRES EXCESSIVELY

Avoid excessive tire spinning when your vehicle is stuck in snow, ice, mud or sand. The centrifugal forces generated by a free-spinning tire/wheel assembly may cause sudden tire explosion, resulting in vehicle damage and/or serious personal injury to you or a bystander. Never exceed 35 mph / 55 kph, as indicated on your speedometer. Use a gentle backward and forward rocking motion to free your vehicle for continued driving. Never stand near or behind a tire spinning at high speeds, for example, while attempting to push a vehicle that is stuck or when an on-the-car spin balance machine is in use.

DO CHECK YOUR TIRES FOR WEAR

Always remove tires from service when they reach two thirty-seconds of an inch (2/32") remaining tread depth. All new tires have tread wear indicators which appear as smooth banks in the tread grooves when they wear to the two thirty seconds of an inch (2/32") level. Many wet weather accidents result from skidding on bald or nearly bald tires. Excessively worn tires are also more susceptible to penetrations.

DO CHECK YOUR TIRES FOR DAMAGE

Frequent (at least monthly) inspection of your tires for signs of damage and their general condition is important for safety. If you have any questions, have your tire Dealer inspect them. Impacts, penetrations, cracks, knots, bulges or air loss always require tire removal and expert

inspection. Never perform a temporary repair or use an inner tube as a substitute for a proper repair. Only qualified persons should repair tires.

PROPER TIRE REPAIR

NOTE: Goodyear does not warrant any inspection or repair process. The repair is entirely the responsibility of the repairer and should be made in accordance with established Rubber Manufacturers Association (RMA) procedures.

Tire Pressure Monitoring System Alert

Refer to your vehicle Owner's Manual for more information on what to do if the tire pressure warning system activates.

THE CONVENIENCE (TEMPORARY) SPARE

The Convenience (Temporary) Spare is designed, built and tested to the high engineering standards set by North America's leading car manufacturers and to Goodyear's own high standards of quality control. It is designed to take up a minimum of storage space and, at the same time, fulfill the function of a spare tire when needed. The spare is kept in its storage space, fully inflated at 60 psi. To be sure it is always ready for use, the air pressure should be checked on a regular basis.

The Convenience (Temporary) Spare can be used in combination with the original tires on your vehicle. You can expect a tire tread life of up to 3,000 miles (4,800 kilometers), depending on road conditions and your driving habits. To conserve tire tread life, return the spare to the storage area as soon as it is convenient to have the standard tire repaired or replaced.

The Convenience (Temporary) Spare weighs less than a standard tire so it's easier to handle. It also helps reduce the total car weight, which contributes to fuel economy. The wheels used with the Convenience (Temporary) Spare are specifically designed for use with high pressure spares and should never be used with any other type tire.

DON'T ATTEMPT TO MOUNT YOUR OWN TIRES

Serious injury or death may result from explosion of tire/rim assembly due to improper mounting procedures. Follow tire manufacturer's instructions and match tire diameter to rim diameter. Mount light truck radials on rims approved for radial service. Do not apply bead sealer. This can inhibit bead seating. Lubricate beads and tire rim (including tube or flap) contact surfaces. Lock assembly on mounting machine or

GOODYEAR DUNLOP TIRES

place in safety cage. STAND BACK and never exceed 40 psi to seat beads. Never use a volatile substance or a rubber “donut” (also known as a bead expander or “O-Ring”) to aid bead seating. Only specially trained persons should mount tires.

DON'T MIX TIRES OF DIFFERENT SIZES AND TYPES ON THE SAME AXLE

For optimum handling and control, Goodyear recommends fitment of four (4) tires of the same type and size unless otherwise specified by the vehicle manufacturer.

WARNING!

Before you replace your tires, always consult the vehicle owner's manual and follow the vehicle manufacturer's replacement tire recommendations. Vehicle handling may be significantly affected by a change in tire size or type. When selecting tires that are different from the Original Equipment size, see a professional installer in order to make certain that proper clearance, load-carrying capacity and inflation pressure are selected. Never exceed the maximum load capacity and inflation pressure listed on the sidewall of the tire. Always drive safely and obey all traffic laws. Avoid sudden, sharp turns or aggressive lane changes. Failure to follow this warning may result in loss of control of the vehicle, leading to an accident and serious injury or death.

When replacing tires, you must maintain the outside diameter and load-carrying capacity of the Original Equipment tire. Inflation pressure may need to be adjusted to avoid overloading the tire. Consult the Tire & Rim Association Load and Inflation Tables, ETRTO or JATMA standards for correct load and inflation information.

NEVER FIT TIRES TO A VEHICLE THAT HAVE LESS LOAD-CARRYING CAPACITY THAN REQUIRED BY THE ORIGINAL EQUIPMENT MANUFACTURER

Examples: Many vehicles, such as large passenger vans, require Load Range E tires as designated by the vehicle manufacturer. Fitment of a tire, such as a Load Range D, with less carrying capacity is not allowed. In other cases, tires of the same size may carry different load indexes in the service description. You must make certain the replacement tires fitted to

the vehicle have a load-carrying capacity equal to or greater than what the Original Equipment manufacturer specifies.

NOTE: Goodyear manufactured and/or marketed European- Metric passenger tires and P-Metric passenger tires are interchangeable as long as they have the same section width, same aspect ratio, same rim diameter.

CAUTION!

<p>Never substitute a "Standard Load" (SL) tire for an Extra Load (XL) or Reinforced tire. If the vehicle was originally equipped with "Extra Load" (XL) or Reinforced tires, replace those tires with similar-sized Extra Load (XL) or Reinforced tires.</p>

FOLLOW THESE ADDITIONAL GUIDELINES

When installing only two tires, fit the tires with the deepest tread depth on the rear axle. If radials and non-radials must be fitted to the same vehicle, fit radials on rear axle. Never mix radials and non-radials on the same axle. When fitting winter tires or all-season tires to performance vehicles, always fit in sets of four. It is not recommended to fit tires with different speed ratings. If tires with different speed ratings are installed on a vehicle, they should be installed with like pairs on the same axle.

The speed capability of the vehicle will become limited to that of the lowest speed rated tires.

Use of lift kits with some vehicle/tire combinations can cause instability. When changing tire sizes, always consult Dealer for optimum rim width and carefully check vehicle/tire clearances.

RETREADED TIRES

Retreaded passenger and light truck tires are not warranted by Goodyear for any reason. Speed ratings and U.S. Department of Transportation test compliance certifications are voided for retreaded tires.

DO MAINTAIN VEHICLE SUSPENSION, WHEEL ALIGNMENT AND BALANCE AND ROTATE YOUR TIRES

Lack of rotation, worn suspension parts, underinflation/ overinflation, wheel imbalance and misalignment can cause vibration or irregular tire wear. Rotate your tires according to your vehicle manufacturer's recommendations or at maximum intervals of 6,000 miles / 10,000 km.

GOODYEAR DUNLOP TIRES

FOR ADDITIONAL INFORMATION, SEE THE "BE TIRE SMART/ PLAY YOUR PART BROCHURE" PUBLISHED BY THE RUBBER MANUFACTURERS ASSOCIATION (RMA). A COPY OF THIS BROCHURE CAN BE DOWNLOADED FROM THE RMA WEBSITE:

www.rma.org/publications/consumer_tire_information

HOW TO READ A TIRE D.O.T. SERIAL NUMBER

D.O.T. stands for Department of Transportation and the number is on the lower sidewall of each tire to show that the tire meets or exceeds the Department of Transportation safety standards.



TIRE SERVICE LIFE

Tires are designed and built to provide many thousands of miles of excellent service. For maximum benefit, tires must be maintained properly to avoid tire damage that may result in removal from service before the tread is worn down to minimum depth.

It is not practical to accurately predict the service life of any specific tire in chronological time since service conditions vary widely. The serviceability of a tire over time is a function of the storage and service conditions (inflation pressure, load, speed, road hazard injury, etc.) to which a tire is subjected. Consumers should not rely solely on the appearance of the tire, but should be aware of any change in dynamic performance such as increased air loss, noise or vibration, which could be a sign to remove the tire. Therefore, it is essential to have tires, including spares, inspected regularly (at least monthly) for proper inflation pressure, damage and treadwear.

Check your vehicle's owner's manual (or your vehicle) to determine if it is equipped with run-flat (extended mobility) tires. If your vehicle is equipped with run-flat tires, the following applies:

RUN-FLAT TECHNOLOGY EXTENDED MOBILITY TECHNOLOGY (EMT™), RUNONFLAT® (ROF) AND DUNLOP SELFSUPPORTING TECHNOLOGY (DSST®) ORIGINAL EQUIPMENT TIRES

IMPORTANT SAFETY INFORMATION

OPERATIONAL MONITORING

The information contained in this Limited Warranty Brochure applies only to the Original Equipment tires supplied with your vehicle. In order for Goodyear Run-Flat (Extended Mobility Technology [EMT], RunOn-Flat [ROF]) or Dunlop Run-Flat (Dunlop Self-Supporting Technology [DSST]) tires to obtain the performance criteria stated within this Limited Warranty, Goodyear or Dunlop Run-Flat tires must use specific parts, such as a low tire pressure monitoring system authorized by the Original Equipment vehicle manufacturer.

RUN-FLAT TIRE FEATURE:

The Goodyear or Dunlop Run-Flat tire is a high-performance tire with a remarkable feature: It can operate for limited distances with very low or even no inflation pressure (refer to your Vehicle Owner's Manual for these limitations). This is an important benefit, especially if inflation loss occurs at a location where immediately stopping your vehicle could be hazardous. **TIRE PRESSURE MONITORING SYSTEM ALERT** Refer to your vehicle Owner's Manual for more information on what to do if the tire pressure warning system activates.

WARNING!

If the tire pressure-monitoring system signals an alert, follow these safety precautions to prevent a loss of vehicle control that could result in serious personal injury or death:

- Slow your speed. Do not exceed 50 mph (80 kph).
- Avoid hard cornering, hard braking and severe handling maneuvers.
- Avoid potholes and other road hazards.

Remember that when your tires have lost air pressure, your vehicle's handling capability is reduced, particularly during severe maneuvers.

TO PROLONG TIRE LIFE DURING A SYSTEM ALERT

The Goodyear or Dunlop Run-Flat tire can be driven at low or zero air pressure (refer to your vehicle Owner's Manual for these limitations). To help prolong the life of a tire operating under low-inflation conditions, drive at a speed as far below 50 mph (80 kph) as possible. Also, drive the shortest distance possible before obtaining tire service. Taking these precautions will increase the chance that your tire will be repairable.

SERVICE AFTER A SYSTEM ALERT

To obtain service after operating under low-inflation conditions, contact your Goodyear or Dunlop Run-Flat service facility. Trained service personnel will inspect your tires to determine if they are in need of repair or replacement. To locate the nearest authorized Goodyear or Dunlop Run-Flat service facility, call 1-800- GOODYEAR 1-800-466-3932 .

WARNING!

Because of the unique characteristics of Run-Flat tires, the wheels on which they are mounted and your vehicle's tire pressure monitoring system, all tire service work other than routine inflation maintenance and external inspections must be performed by service personnel at a Goodyear or Dunlop Run-Flat service facility.

Do not attempt to mount or demount Run-Flat tires yourself; serious injury or death could result. Only specially trained persons should mount, demount and repair Run-Flat tires, and more than 40 psi (270 kPa) may be required to seat beads. A safety cage and clip-on extension air hose must be used if more than 40 psi (270 kPa) is need to seat beads.

TIRE REPAIR

Like any other Goodyear or Dunlop speed-rated, high-performance tire, the Goodyear or Dunlop Run-Flat tire may be repaired to correct a puncture in the tread, but **PROPER MATERIALS AND PROCEDURES MUST BE USED**. Contact a Goodyear or Dunlop Run-Flat service facility for information on proper repairs. For the location of the nearest facility, call 1-800-GOODYEAR 1-800-466-3932 .

WARNING!

Goodyear and Dunlop Run-Flat tires are designed for use only on certain original equipment wheels supplied with a properly operating low tire pressure-monitoring system. If applied to a vehicle without a properly operating low tire pressure monitoring system, the tires may fail when operated in an underinflated condition, resulting in loss of vehicle control and possible serious injury or death. Application of these tires to a vehicle not equipped with specified operational low tire pressure-monitoring system constitutes improper and unsafe use of this product.

FOR SERVICE ASSISTANCE OR INFORMATION, FIRST CONTACT THE NEAREST GOODYEAR OR DUNLOP RETAILER

1. For assistance in locating the nearest Goodyear or Dunlop Retailer, look in the Yellow Pages under Tire Dealers – New.
2. Go to www.goodyear.com for U.S. or www.goodyear.ca for Canada. For Dunlop tires, go to www.dunloptires.com for U.S. & Canada. If additional assistance is required, call the Customer Assistance Center at 1-800-321-2136 for U.S. or 1-800-387-3288 for Canada.

Or write to:

Customer Assistance Center Dept 728 200 Innovation Way Akron, OH 44316-0001

NOTES

HANKOOK TIRES

LIMITED WARRANTY FOR ORIGINAL EQUIPMENT PASSENGER CAR & LIGHT TRUCK TIRES INCLUDING TEMPORARY TIRES

WHAT IS COVERED AND FOR HOW LONG

Hankook warrants that a tire manufactured by Hankook and equipped originally on the vehicle is free from defects in materials or workmanship in normal use for the life of the original usable tread. The life of the original usable tread ends when the tire tread has been worn down with only 1.6 mm (2/32 nds inch) remaining, at which point the tire is considered to be fully worn out.

PASSENGER CAR AND LIGHT TRUCK TIRES

1. Free replacement

If Hankook Radial Passenger & Light Truck Tires fail as a result of defect in material and/or workmanship within the first 25% of treadwear, the tire will be replaced with a new, comparable Hankook Tire at no charge including mounting and balancing charges.

2. Pro rated replacement

Tires not qualifying for free replacement will be allowed a credit toward purchase of a new, comparable Hankook Tire based upon the amount of tread actually worn. The cost of mounting, balancing and any other service charges or applicable taxes shall be paid by the user. Otherwise adjustment for compensation will be made on a prorata basis calculated by multiplying the actual current dealer selling price by the percentage of remaining usable tread depth.

HANKOOK TEMPORARY TIRE

1. A Temporary tire weighs less and provides more trunk storage space than a conventional tire. To conserve tire tread life, temporary tire should be returned to the trunk as soon as it is convenient to have your standard tire repaired or replaced.

HANKOOK TIRES

2. If Hankook Temporary Tire fails as a result of defect in materials and/or workmanship during the first 50% of usable treadwear, the tire will be replaced with a new, comparable tire at no charge including mounting charge. No adjustment will be made for tires that are worn more than 50%.

WHAT IS NOT COVERED BY THE WARRANTY

NON ADJUSTABLE CONDITIONS

1. Irregular wear or tire damage due to:
 - Road hazards such as punctures, cuts, snags, scuffs, carcass bruises or impact breaks.
 - Fire, wreck or collision
 - Improper inflation, overloading, high speed spinning, improper mounting or demounting, running flat, off-road use, racing, vandalism, willful damage or abuse.
 - Misalignment, wheel imbalance, defective brakes or shock absorber, use of tire chains.
 - Any tire which has failed as a result of adding materials (e.g. tire fillers, sealant, or balancing substances).
 - Mechanical failure or design of vehicle.
2. Tires fitted to anything other than the original vehicles.
3. Tire worn beyond tread wear indicator (2/32 nds inch or 1.6 mm tread remaining).
4. Tire presented by other than the actual owner-user.
5. Tire branded "NA" (meaning no adjustment) or "blem" (meaning blemished).
6. Loss of time inconvenience, loss of use of the vehicle or consequential damage.
7. Ride disturbance caused by damaged wheels or after free-replacement conditions.
8. Tire with weather cracking which was purchased more than four years prior to presentation for adjustment.

GENERAL EXCLUSIONS

1. No Hankook Tire employee, retailer or dealer has the authority to make any warranty, representation, promise or agreement on behalf of Hankook Tire except as stated in this policy.
2. Tires used in racing related activities or competitive events are not covered by this warranty.
3. Limitation of remedy: to the extent permitted by law, HANKOOK disclaims liability for all consequential and incidental damages. Some provinces and states do not allow the exclusion or limitation of incidental or consequential damages, so the above limitation or exclusion may not apply to you. This warranty gives you specific legal rights, and you may also have the rights which vary from province to province in Canada, and from state to state in the U.S.A.

HANKOOK'S OBLIGATIONS

Replacement qualifying under this warranty will be made by a participating Hankook Dealer or a participating Car Dealer.

OWNER'S OBLIGATIONS

1. You must present the tire to a participating Hankook Dealer or a participating Car Dealer.
2. For free replacement, a proof of purchase date such as car dealer invoice should be presented.
3. No claim will be recognized unless submitted on a Hankook claim form completely filled out and signed by the owner or a participating Hankook Dealer or Car Dealer.

WARNING FOR YOUR SAFETY**• TIRE DEMOUNTING AND MOUNTING**

Improper tire mounting and inflation procedures may cause tire beads to break with explosive force during installation of the tire on the rim, causing personal injury and property damage. Follow the Rubber Manufacturers Association installation and safety procedure for mounting and inflating tires. Tire and rim must match in size. Rim parts must match by manufacturer's design. Clean rim. Lubricate rim

HANKOOK TIRES

and beads. Do not exceed the maximum recommended pressure to seat beads on rim. Use remote control inflation equipment and inflation cage.

NOTE:

- Never inflate over 40 psi to seat beads.
- Mount radial ply tires only on rims designated by wheel manufacturer as suitable for radial tire.
- Only specially trained persons shall mount tires.
- **AIR PRESSURE**

Check the pressure in your tires, including your spare, at least monthly, and always before and during extended driving. Check tires cold (at least 3 hours after the vehicle has been stopped and before it is driven more than 1.6 kilometers or 1 mile). Do not reduce pressure when tires are hot, use an accurate air pressure gauge to check pressure and maintain it at the level recommended on the vehicle tire placard or in the Owner's Manual. Under inflation produces extreme flexing of sidewalls and builds up heat to the point that premature tire failure may occur. Over inflation can cause the tires to be more susceptible to impact damage. Cold tire pressures, however, should never be higher than the limit molded on the sidewall.

- **LOAD LIMITS**

Never exceed the load-carrying limits molded onto the sidewall of your tires or the maximum vehicle load limit as shown on the vehicle tire placard, whichever is less. Overloading builds up excessive heat in the tire and leads to early and/or sudden failure.

- **HAZARDS**

Avoid running over objects (e.g., chuckholes, rocks, curbs, metal, glass, etc.) which may possibly cause internal tire damage. Continued use of a tire that has suffered internal damage (which may not be externally visible) can lead to dangerous tire failure. Determination of suspected internal damage requires demounting the tire from its rim and examination by trained tire personnel.

- **WORN TIRES**

Never drive on worn tires. Tires should be replaced by trained personnel when 2/32 nds inch (1.6 mm) of tread depth remain, as indicated by treadwear indicators molded into the tread grooves. Use of worn-out tires (less than 2/32 nds of an inch remaining tread depth) increases the probability of tire failure. In most states, it is illegal to drive with less than 2/32 nds of an inch of remaining tread depth.

- **SPEED LIMITS**

Operating your vehicle in excess of lawful speed limits or the maximum speeds justified by driving conditions can be dangerous. Excessive speed creates heat buildup in a tire, leading to possible tire failure.

- **SPEED-RATED TIRES**

Speed-rated tires are identified by letters S, T, H, V, W, or Z as either part of the size designation (e.g., HR), or part of the service description adjacent to the size designation (e.g., 94H) and indicates the maximum speed capability of the tire when properly loaded and inflated. However, even when properly loaded and inflated, driving for prolonged periods at high speeds can cause tire damage and possible tire failure which could lead to an accident. Original equipment speed-rated tires must be replaced with tires of the same or higher speed rating if the speed capability of the vehicle is to be maintained. Consult your Hankook dealer for the tires best suited to your vehicle driving habit. Repairing of speed-rated tires must be done in accordance with RMA repair procedures and is limited to one 1/4" diameter repair in the tread area.

- **TIRE ROTATION**

Rotate your tires for longer tire life. Front and rear tires perform different jobs and can wear differently. Consult your vehicle Owner's Manual for mileage recommendations and rotation patterns.

HANKOOK TIRES

- **ADDITIONAL SAFETY INFORMATION FOR TEMPORARY TIRE**

- Air pressure.

Check inflation pressure as soon as practical after installation and inflate to 60 psi. The tire pressure should be checked monthly and maintained at 60 psi while the tire is stored or in service.

- Vehicle restriction.

The temporary spare tire was specifically designed for your car and should not be used on any other vehicle.

- Other restrictions.

The temporary spare tire should not be used with other wheels, nor should standard tires, snow tires, wheel covers, or trim rings be used with the temporary spare wheel. If such use is attempted, damage to these items or other vehicle components may occur.

TIRE SERVICE ASSISTANCE OR INFORMATION

When you have tire problems, Hankook provides service and assistance.

Any time you see damage to your tires, contact your local Hankook Tire Dealer.

If no local dealer is available around you, dial Hankook Toll Free Service Number so that you can get information on where and how service is rendered to you.

FOR SERVICE ASSISTANCE OR INFORMATION

U.S.A.

CORPORATE HEADQUARTERS

1450 Valley Road, Wayne, New Jersey 07470

1-973-633-9000 Toll Free 1-877-740-7000

WEST REGIONAL OFFICE

11555 Arrow Route, Suite 105, Rancho Cucamonga, CA 91730

1-909-481-9800 Toll Free 1-800-426-8252

CANADA

CORPORATE HEADQUARTERS

30 Resolution Dr., Brampton, Ontario L6W 0A3

1-905-463-9802 Toll Free 1-800-843-7709

KUMHO TIRES

Kumho And Marshal Brand Limited Warranty



Congratulations! You have just purchased high quality tires from Kumho Tire U.S.A. Inc. This limited warranty covers the

KUMHO and Marshal brand of passenger and light truck tires.

I. WHAT IS WARRANTED AND WHO IS ELIGIBLE UNDER THIS WARRANTY

Kumho Tire U.S.A. Inc., 10299 6th Street, Rancho Cucamonga, California 91730, warrants to the original consumer purchaser that all KUMHO replacement radial tires either directly or through an authorized KUMHO dealer, and which are mounted on cars within the U.S.A., and becomes unserviceable for any reason within the manufacturers control, such tire will be replaced with an equivalent KUMHO tire.

WHAT IS COVERED BY THE WARRANTY AND HOW LONG:

Should any tire manufactured by Kumho Tire Co., Inc. covered by this warranty become unserviceable due to a material or workmanship condition during its useable tread life (more than 2/32" remaining tread) before 6 years from the date of manufacture or purchase date supported with proof of purchase for every passenger and light truck tire (whichever comes first), and before 5 years (6 years for KLS02e, KLD01e, and KLT02e patterns) from the date of manufacture or purchase date for commercial truck tires (whichever comes first), KUMHO will do either of the following:

1. During the first 2/32" of the original usable tread, Kumho will replace such tire with a comparable new KUMHO or Marshal tire free of charge. Applicable taxes on the new tire and costs of mounting and balancing and any other service charges are payable by the owner.

KUMHO TIRES

2. After the first $2/32''$ of the original usable tread, a credit percentage will be given toward the purchase price of a comparable new Kumho or Marshal tire effective at the time of adjustment. Applicable taxes on the new tire and costs of mounting and balancing service are payable by the owner.

To obtain the credit percentage, please refer to Adjustment Credit Percentage Table or utilize the following example:

R.T.D.: Remaining Tread Depth

O.T.D.: Original Tread Depth

If R.T.D. = 5 and O.T.D. = 10, the calculation is $(5 - 2 : \text{remaining useable tread depth}) \div (10 - 2 : \text{original useable tread depth}) = 38\%$

3. Temporary Spare Tire

During the first $1/32''$ of the original usable tread, Kumho will replace such temporary tire with a comparable new Kumho temporary tire free of charge. After the first $1/32''$ of the original usable tread, but less than $2/32''$, a credit of 50% towards a comparable new Kumho temporary tire will be given. Applicable taxes and costs of mounting and balancing and any other service charges are payable by the owner.

4. Adjustment on ride complaint or out-of-round is allowed only during the first $2/32''$ of the original tread depth.

Adjustment Credit Percentage Based on Remaining Tread Depth

O.T.D. (Original Tread Depth)	O.T.D. (Original Tread Depth)																																								
	8	9	10	11	12	13	14	15	16	17	18	19	20	21	22	23	24	25	26	27	28	29	30	31	32																
2 / 32	0	0	0	0	0	0	0	0	0	0	0	0	0	0	0	0	0	0	0	0	0	0	0	0	0	0	0	0	0	0	0	0	0	0	0	0	0				
3 / 32	15	14	11	11	10	9	8	8	7	7	6	6	6	5	5	5	5	4	4	4	4	4	4	3	3																
4 / 32	50	29	25	22	20	18	17	15	14	13	13	12	11	11	10	10	9	9	8	8	8	7	7	7	7																
5 / 32	65	43	38	33	30	27	25	21	21	20	19	18	17	16	15	14	14	13	13	12	12	11	11	10	10																
6 / 32	75	57	50	44	40	36	33	31	29	27	25	24	22	21	20	19	18	17	17	16	15	15	14	14	13																
7 / 32	100	100	63	56	50	45	42	38	36	33	31	29	28	26	25	24	23	22	21	20	19	19	18	17	17																
8 / 32	100	100	100	67	60	55	50	46	43	47	38	35	33	32	30	29	27	26	25	24	23	22	21	21	20																
9 / 32		100	100	100	70	64	58	54	50	48	44	41	39	37	35	33	32	30	29	28	27	26	25	24	23																
10 / 32			100	100	100	73	67	63	58	53	50	47	44	42	40	38	36	35	33	32	33	30	29	28	27																
11 / 32				100	100	100	75	69	64	60	56	53	50	47	45	43	41	39	38	36	35	33	32	31	30																
12 / 32					100	100	100	77	71	67	63	59	56	53	50	48	45	43	42	40	38	37	36	34	33																
13 / 32						100	100	100	79	73	69	65	61	58	55	52	50	48	46	44	42	41	39	38	37																
14 / 32							100	100	100	80	75	71	67	63	60	57	55	52	50	48	45	44	43	41	40																
15 / 32								100	100	100	81	76	72	68	65	61	59	57	54	52	50	48	46	45	43																
16 / 32									100	100	100	82	78	74	70	67	64	61	58	56	54	52	50	48	47																
17 / 32										100	100	100	85	79	75	71	68	65	63	60	58	56	54	52	50																
18 / 32											100	100	100	84	80	76	73	70	67	64	62	59	57	55	53																
19 / 32												100	100	100	85	81	77	74	71	68	65	63	61	59	57																
20 / 32													100	100	100	86	82	78	75	72	69	67	64	62	60																
21 / 32														100	100	100	86	83	79	76	73	70	68	66	63																
22 / 32															100	100	100	87	83	80	77	74	71	69	67																
23 / 32																100	100	100	88	84	83	78	75	71	70																
24 / 32																	100	100	100	87	85	81	79	76	73																
25 / 32																		100	100	100	88	85	82	79	77																
26 / 32																			100	100	100	89	86	83	80																
27 / 32																				100	100	100	89	86	83																
28 / 32																					100	100	100	90	87																
29 / 32																						100	100	100	90																
30 / 32																							100	100	100																
31 / 32																								100	100																
32 / 32																									100																

The authorized KUMHO or Marshal dealer will determine the adjustment cost by multiplying the percentage of the original usable tread worn by the current KUMHO or Marshal dealer’s price list in effect at the time of adjustment.

WHAT IS NOT COVERED BY THE WARRANTY:

1. This limited warranty is applicable only in the United States, and any tires used or equipped on a vehicle registered or operated outside the U.S. are not covered by this warranty.
2. Tires branded or marked "Non-Adjustable (NA) or Blemished (Blem) or DOT/Serial numbers previously cut will not be adjusted.
3. Any tire worn beyond the wear bars (less than 2/32" remaining tread).

KUMHO TIRES

4. The cost of applicable taxes and mounting and balancing and any other service charges.
5. Tire damage or irregular wear due to:
 - A. Road hazard, including puncture, cut, impact break, bulge, snag, stone drill, collision.
 - B. Continued use while run flat or under acute under-inflation.
 - C. Improper use or operation, without limitation, improper inflation pressure, overloading, use of an improper rim, tire/wheel assembly imbalance or other vehicle condition, worn suspension components, improper mounting or de-mounting, misuse, misapplication, fire or other externally generated heat, water or other material trapped inside the tire during mounting, tire alteration, racing or competition purposes, improper inserting of sealant, balance or filler materials.
 - D. Improper repair, or with repairs not conforming to the Rubber Manufacturers Association standards, or with section repairs, or with self-vulcanizing plug only.
 - E. Failure to rotate the tire at least every 5,000 miles as evidenced by Kumho's Mileage Warranty/Tire Rotation Card (printed in this brochure) or vehicle misalignment.
 - F. Uneven or rapid wear which is caused by mechanical irregularity in the vehicle such as misalignment, (a measured tread difference of $\frac{2}{32}$ nds of an inch or more across the tread on the same tire).
6. Ozone or weather cracking on tires over four (4) years from the date of manufacture.
7. Tires that have been recapped, or retreaded, regrooved.
8. Ride disturbance (out-of-round, vibration, pulling, etc.) claims submitted after the first $\frac{2}{32}$ " of tread wear.
9. Loss of time, or use, inconvenience, or any incidental or consequential damage.
10. Tires that have been modified by the addition or removal of material or any tire intentionally altered to change its appearance.
11. Tires unserviceability caused by the tire operation in excess of tire/wheel manufacturers specifications and recommendations.

12. Tires that are misapplied due to insufficient speed rating, or undersized, or oversized tires.
13. Tires that have become unserviceable because chemical corrosion, vandalism, chains and flat spotting.
14. Tires involved in any racing-related activities.
15. This limited warranty applies only to the original purchaser and is nontransferable.

OWNERS OBLIGATION:

In order to be eligible for KUMHO's limited warranty program, the owner must:

1. Conform to all pertaining policies detailed herein.
2. Present tire to any authorized KUMHO dealer for inspection along with a copy of their original purchase receipt. Dealer will inspect tire in order to identify whether or not it qualifies for warranty based on the policies detailed herein.
3. Pay the amounts due on a new tire, less the amount of credit including taxes, mounting and balancing charges and/or the cost of other services ordered.

To locate an authorized KUMHO/Marshall dealer, use our web address WWW.KUMHOTIREUSA.COM/DEALER or call (800) HI-KUMHO 1-800-445-8646 .

OTHER RIGHTS:

This limited warranty gives the owner of KUMHO tires specific legal rights and you may also have other rights, which vary from state to state.

KUMHO TIRES

II. LIMITED TREAD WEAR WARRANTY

FOR PASSENGER RADIAL TIRES:

Pattern	Mileage Coverage	Pattern	Mileage Coverage
KU27	60,000 MILES	KH16	60,000 MILES
KR26	40,000 MILES	KR21	85,000 MILES
PA31	50,000 MILES	KU22-II	40,000 MILES
TA31	60,000 MILES	TA71	60,000 MILES (Available 3rd Quarter 2015)
		TA11	75,000 MILES (Available 3rd Quarter 2015)

FOR LIGHT TRUCK TIRES:

Pattern	Mileage Coverage	Pattern	Mileage Coverage
KL21	60,000 MILES	KL33	60,000 MILES
AT51	55,000 MILES	(P-Metric Only)	(Available 3rd Quarter 2015)

Neither Kumho Tire U.S.A., Inc., nor any other tire manufacturer, can guarantee you'll receive a certain number of miles from any given tire. Driving habits, driving conditions, road conditions and vehicle maintenance all play a vital role in the tread life of a tire. However, if a tire does not reach the warranted mileage, and the original owner of the tires has complied with the terms and conditions of the Limited Tread Wear Warranty, KUMHO will replace the tires as follows:

1. If tread has worn down to the tread wear indicators (2/32nds tread depth) within 72 months from the date of purchase (or manufacturer) or does not deliver the warranted miles of normal passenger use, whichever comes first, Kumho Tire U.S.A., Inc. will make an allowance for unused service towards a comparable new tire, pro-rated on warranted miles.
2. The replacement allowance will be calculated by percentage of the warranted miles not received multiplied to the predetermined adjustment price of the tire at the time and place of the adjustment.
3. For original equipment tires on new vehicles, please reference separate warranty brochure in your vehicle's glove box.

Mileage up to	Percent KUMHO Pays Per Original Warranty Mileage							Mileage up to	Percent KUMHO Pays Per Original Warranty Mileage						
	20k	40k	50k	55k	60k	75k	85k		40k	50k	55k	60k	75k	85k	
1,000	95%	98%	98%	98%	98%	99%	99%	99%	44,000						
2,000	90%	95%	96%	96%	96%	97%	97%	98%	45,000	12%	20%	27%	41%	48%	
3,000	85%	93%	94%	95%	95%	96%	96%	96%	46,000	10%	18%	25%	40%	47%	
4,000	80%	90%	92%	93%	93%	95%	95%	95%	47,000	8%	16%	23%	39%	46%	
5,000	75%	88%	90%	91%	92%	93%	94%	48,000	6%	15%	22%	37%	45%		
6,000	70%	85%	88%	89%	90%	92%	93%	49,000	4%	13%	20%	36%	44%		
7,000	65%	83%	86%	87%	88%	91%	92%	50,000	2%	11%	18%	35%	42%		
8,000	60%	80%	84%	85%	87%	89%	91%	51,000	0%	9%	17%	33%	41%		
9,000	55%	78%	82%	84%	85%	88%	89%	52,000		7%	15%	32%	40%		
10,000	50%	75%	80%	82%	83%	87%	88%	53,000		5%	13%	31%	39%		
11,000	45%	73%	78%	80%	82%	85%	87%	54,000		4%	12%	29%	38%		
12,000	40%	70%	76%	78%	80%	84%	86%	55,000		2%	10%	28%	36%		
13,000	35%	68%	74%	76%	78%	83%	85%	56,000		0%	8%	27%	35%		
14,000	30%	65%	72%	75%	77%	81%	84%	57,000			7%	25%	34%		
15,000	25%	63%	70%	73%	75%	80%	82%	58,000			5%	24%	33%		
16,000	20%	60%	68%	71%	73%	79%	81%	59,000			3%	23%	32%		
17,000	15%	58%	66%	69%	72%	77%	80%	60,000			2%	21%	31%		
18,000	10%	55%	64%	67%	70%	76%	79%	61,000			0%	20%	29%		
19,000	5%	53%	62%	65%	68%	75%	78%	62,000				19%	28%		
20,000	0%	50%	60%	64%	67%	73%	76%	63,000				17%	27%		
21,000		48%	58%	62%	65%	72%	75%	64,000				16%	26%		
22,000		45%	56%	60%	63%	71%	74%	65,000				15%	25%		
23,000		43%	54%	58%	62%	69%	73%	66,000				13%	24%		
24,000		40%	52%	56%	60%	68%	72%	67,000				12%	22%		
25,000		38%	50%	55%	58%	67%	71%	68,000				11%	21%		
26,000		35%	48%	53%	57%	65%	69%	69,000				9%	20%		
27,000		33%	46%	51%	55%	64%	68%	70,000				8%	19%		
28,000		30%	44%	49%	53%	63%	67%	71,000				7%	18%		
29,000		28%	42%	47%	52%	61%	66%	72,000				5%	16%		
30,000		25%	40%	45%	50%	60%	65%	73,000				4%	15%		
31,000		23%	38%	44%	48%	59%	64%	74,000				3%	14%		
32,000		20%	36%	42%	47%	57%	62%	75,000				1%	13%		
33,000		18%	34%	40%	45%	56%	61%	76,000					12%		
34,000		15%	32%	38%	43%	55%	60%	77,000					11%		
35,000		13%	30%	36%	42%	53%	59%	78,000					9%		
36,000		10%	28%	35%	40%	52%	58%	79,000					8%		
37,000		8%	26%	33%	39%	51%	56%	80,000					7%		
38,000		5%	24%	31%	37%	49%	55%	81,000					6%		
39,000		3%	22%	29%	35%	48%	54%	82,000					5%		
40,000		0%	20%	27%	33%	47%	53%	83,000					4%		
41,000			18%	25%	32%	45%	52%	84,000					3%		
42,000			16%	24%	30%	44%	51%	85,000					2%		
43,000			14%	22%	28%	43%	49%						0%		

ELIGIBILITY FOR LIMITED TREAD WEAR WARRANTY:

- To make a claim, the owner must present the original customer copy of KUMHO's Mileage Warranty Card (printed in this brochure), which records the date of purchase, name of purchaser, original mileage and identification of the vehicle to an authorized KUMHO dealer.

MILEAGE WARRANTY / TIRE ROTATION CARD

KUMHO TIRES **7** PATTERN: _____ MILEAGE COVERAGE: _____ **Nº**

NAME _____		TIRE PURCHASED		STORE NAME _____	
STREET _____		Size: _____		STREET _____	
CITY _____		Qty: _____		CITY _____	
STATE _____ ZIP _____		Date: _____		STATE _____ ZIP _____	
Dealer Invoice # _____		YEAR _____		LIC. NO. _____	

Nº	Nº	Nº	Nº	Nº
SERIAL NO. _____	SERIAL NO. _____	SERIAL NO. _____	SERIAL NO. _____	SERIAL NO. _____
ODMETER READING	ODMETER READING	ODMETER READING	ODMETER READING	ODMETER READING
ON _____	ON _____	ON _____	ON _____	ON _____
OFF _____	OFF _____	OFF _____	OFF _____	OFF _____
DATE	DATE	DATE	DATE	DATE
ON _____	ON _____	ON _____	ON _____	ON _____
OFF _____	OFF _____	OFF _____	OFF _____	OFF _____

- This limited tread wear warranty applies only to the original owner and is non-transferable.

KUMHO TIRES

3. Applicable taxes and costs of mounting and balancing and any other service charges are payable by the owner.
4. The owner must rotate the tires every 5,000 miles.
5. The following are exclusions to the Limited Tread Wear Warranty:
 - Tires branded "NA", "Blem", etc.
 - Tires exhibiting uneven or rapid wear which is caused by mechanical irregularity in the vehicle such as misalignment, (a measured tread difference of 2/32nds of an inch or more across the tread on the same tire).
 - Tires worn-out or damaged due to:
Improper inflation, improper mounting, uneven wear, overloading or off-road driving, run flat or racing, accident, fire or chemicals, use on RV or commercial vehicle, vandalism or gross abuse, defective mechanical condition of vehicle, road hazard damage (e.g., irreparable cut, puncture, snag, bruise or impact break) and lack of tire rotation.
 - Original equipment tires on new vehicles.
6. For staggered/split fitment applications (different size tires on the front and rear axles), Kumho Tire will cover half the number of miles of the standard mileage warranty since these tires cannot be rotated as recommended by Kumho.

III. ROAD HAZARD PROTECTION

Every KR21/ KU39/ KU27/ KU22 II/ KU31/ TA31/ TA11 (Available 3rd Quarter 2015) steel belted radial passenger tire that has been irreparably damaged due to a normal road hazard conditions (e.g., irreparable cut, puncture, snag, bruise or impact break) within the first 2/32" of the original tread depth (O.T.D.) and within 12 months from the date of purchase, will be replaced free of charge with an equivalent KUMHO tire. To be eligible, you must present your original invoice showing date of purchase. Tires not within 2/32" of the O.T.D. will not be issued a pro-rated credit. Tires that reflect damage due to continued run flat or acute underinflation are excluded.

IV. 30-DAY SATISFACTION GUARANTEED TRIAL WARRANTY

Kumho Tire's 30-Day Satisfaction Guaranteed Trial Warranty covers a complete set of four (4) Road Venture AT51 and Solus TA71 tires. If for whatever reason you aren't completely satisfied with your eligible tires, simply return them to the dealer where they were purchased for replacement.

Limitations and Requirements

- This trial warranty only applies to the original purchaser of a set of four eligible (4) tires returned within 30 days from the date of purchase and is non-transferable; any return of less than a full set of tires will not be accepted. Original purchaser must present their original sales receipt/invoice to their selling dealer at the time of replacement.
- Tires must be returned undamaged. Tires exhibiting road hazard, mounting damage, vehicle mechanical-related problems, repairs, improper inflation, vandalism, run flat, racing or any tires removed from the original vehicle are excluded from this trial warranty.
- Original purchaser pays the amounts due on a new replacement tire, less the amount of credit, including applicable taxes, mounting and balancing charges and/or the cost of other services ordered.
- Tires measuring more than 1/32" of tread wear from original tread depth are excluded from trial warranty.

NEW ON REAR/ROTATION RECOMMENDATION

1. Replacement of two tires: Kumho Tire recommends replacing all four tires at the same time. However, when only two tires are replaced, the new tires should be put on the rear. The newer tires, with deeper tread, may provide better grip and water evacuation in wet driving conditions.
2. Tire Rotations: Owners must continue to rotate tires in accordance to their vehicle owner's manual or every 5,000 miles. Side-to-side rotation on "new on rear; two-tire replacements" fitments will be acceptable.

KUMHO TIRES

V. CASING CREDIT

1. Casing of KUMHO radial commercial truck tires are warranted to remain serviceable through the second retreaded life for 66 months from the date of manufacture.
2. KLS02a, KLD01a, and KLT02e casing warranty is valid through the second retreaded life for 72 months from the date of manufacture.
3. If an examination by KUMHO shows that a casing of a KUMHO radial truck tire delivers unsatisfactory service due to factors within the manufacturer's control, KUMHO will give a credit toward the purchase price of a comparable new KUMHO tire in the amount indicated in the Casing Credit table.

Tire Size	Casing Value
8.25R15, 7.50R16, 8R17.5	\$30.00
215/75R17.5, 235/75R17.5	\$30.00
225/70R19.5, 245/70R19.5	\$30.00
265/70R19.5, 285/70R19.5	\$30.00
8.25R16	\$35.00
255/70R22.5	\$50.00
9.00R20, 10R22.5	\$60.00
10.00R20, 295/80R22.5	\$80.00
11.00R20, 12.00R20	\$90.00
10.00R22, 11.00R22, 12.00R24	\$90.00
11R22.5, 295/75R22.5	\$95.00
11R24.5, 285/75R24.5	\$95.00
12R22.5, 315/80R22.5	\$100.00
385/65R22.5, 425/65R22.5, 445/65R22.5	\$100.00

4. Radial truck tires used in mining service are not eligible under this program.

VI. REPLACEMENT WARRANTY

If you receive a replacement tire under this warranty, it will be covered by the manufacturer's warranty and the supplemental limited mileage warranty that Kumho Tire U.S.A., Inc., than gives on that tire.

THIS IS THE ONLY EXPRESS WARRANTY GIVEN BY KUMHO APPLICABLE TO KUMHO/MARSHAL REPLACEMENT TIRES. KUMHO DOES NOT MAKE ANY OTHER EXPRESS WARRANTY

OR IMPLIED WARRANTY OF MERCHANT ABILITY OR FITNESS FOR A PARTICULAR PURPOSE.

KUMHO DOES NOT AUTHORIZE ANY OTHER PERSONS, INCLUDING AUTHORIZED DEALERS TO CHANGE THIS WARRANTY OR CREATE ANY OTHER OBLIGATION IN CONNECTION WITH KUMHO/MARSHAL TIRES. KUMHO WILL NOT DO ANYTHING OTHER THAN WHAT IS STATED IN THIS WARRANTY IF A DEFECT IS FOUND TO EXIST IN A KUMHO/MARSHAL REPLACEMENT RADIAL TIRE. ALL OTHER REMEDIES ARE EXCLUDED, INCLUDING ANY OBLIGATION OR LIABILITY ON THE PART OF KUMHO FOR CONSEQUENTIAL OR INCIDENTAL DAMAGES (SUCH AS LOSS OF USE OF CAR, LOSS OF TIME OR INCONVENIENCE) ARISING OUT OF A DEFECT.

THE REMEDIES SET FORTH IN THIS LIMITED WARRANTY ARE THE SOLE AND EXCLUSIVE REMEDIES FOR BREACH OF WARRANTY. SOME STATES DO NOT ALLOW THE EXCLUSION OR LIMITATION OF INCIDENTAL OR CONSEQUENTIAL DAMAGES, SO THE ABOVE LIMITATIONS OR EXCLUSIONS MAY NOT APPLY TO YOU. THIS WARRANTY GIVES YOU SPECIFIC LEGAL RIGHTS, AND YOU MAY ALSO HAVE OTHER RIGHTS THAT MAY VARY FROM STATE TO STATE.

WARNING!

Property damage, serious personal injury or death may result if any of the following safety precautions/recommendations are not followed:

→ Driving on any underinflated tire is dangerous and may result in sudden tire destruction caused by excessive heat build-up. For replacement tires, your tire retailer should provide you with the proper inflation pressure. Otherwise, follow the air pressure recommendation found within your vehicle's owner manual or tire placard in your vehicle. If your replacement tire size is different from the original equipment tire size, ask your tire retailer for a revised air pressure recommendation guide in order to adequately support your vehicle's GVWR.

(Continued)

WARNING! (Continued)

- Check the cold inflation pressure in all of your tires, including the spare tire, at least once every week and always prior to long distance trips. Failure to maintain the proper air inflation pressure may result in improper vehicle handling, and may cause rapid and irregular tire wear, reduction in tire durability, loss of vehicle control, or sudden tire failure that may lead to property damage, serious personal injury or death.
- Use an accurate tire gauge to check tire air pressures. Always maintain the proper recommended air inflation pressure in all tires. If there is an indication that one of your tires has lost four or more pounds of air pressure, immediately look for signs of penetration through the tire, valve leaks or wheel damage that may account for the air loss. You should also have your tires inspected by a tire retailer immediately.
- Air pressure should be checked when tires are cold (before they have been driven), ideally in the early morning. Driving, regardless of distance, causes tires to heat up and simultaneously increase air pressure.
- Never exceed the maximum inflation pressure for the tire.
- Never bleed air from hot tires as this may result in underinflation.
- → Inspect your tires daily. If you notice any damage to your tires or wheels, replace them with a spare and immediately visit any tire retailer for advice. Driving over potholes, curbs, wood debris, metal, etc., can damage a tire and should be safely avoided. Contact with such hazards requires an immediate and thorough tire inspection by your tire retailer.
- Always examine your tires for penetrations, bulges, cracks, cuts, and abnormal wear – particularly at the tire edges – which may be caused by, for example, vehicle misalignment or tire underinflation. Failure to properly control a vehicle when one or more tires are underinflated may result in an accident. Use of a damaged tire may result in rapid air loss, including sudden tire failure.
- An explosion of the tire/rim assembly may occur due to improper mounting. Only specially trained persons should mount tires.
- → Failure to store tires in accordance with the following recommendations may result in damage to your tires, reduction in tire durability, or sudden tire failure:

(Continued)

WARNING! (Continued)

- Tires should always be stored in a cool, dry, clean, indoor environment. Tires contain waxes and emollients to protect their outer surfaces from ozone and weather cracking. As the tire rolls and flexes, the waxes and emollients continually migrate to the tire's surface, replenishing this protection throughout the normal and proper use of the tire. However, when tires sit outdoors and are unused for an extended period of time, the tire surface becomes dry, the tire may be susceptible to ozone and weather cracking, and the casing becomes susceptible to flat spotting.
- Surfaces on which tires are stored must be free from grease, gasoline, and other substances that could deteriorate the rubber.
- You should have a qualified technician check all tires where the Kumho Tire U.S.A., Inc. warranty policy period has lapsed, even if damage is not obvious.
- → Do not overload your tires. Driving on any overloaded tire is extremely dangerous and may result in an accident causing property damage, serious personal injury or death.
- The maximum load rating marked on the sidewall of any tire is based on the maximum speed of operation. Tires that are loaded beyond their maximum allowable loads for a particular application will generate increased and excessive heat that may cause sudden tire failure leading to property damage, serious personal injury or death.

KUMHO TIRES

FOR FURTHER ASSISTANCE

Contact your authorized KUMHO Tire retailer or call KUMHO Consumer Relations at:

Corporate Office & Western Division
10299 6th Street
Rancho Cucamonga, CA 911730
(800) HI-KUMHO 1-800-445-8646
WWW.KUMHOTIREUSA.COM



KUMHO TIRE U.S.A. INC.

Southeast Division
1240 Highway 155 South
Mcdonough, GA 30253-7361
1-678-593-1420

Northern Midwest Division
760 W. Crossroads Parkway, Unit B
Bolingbrook, IL 60440
1-815-886-7914

Kumho Technical Center
711 Kumho Drive
Akron, OH 44333
1-330-666-4030

MICHELIN

Original Equipment Passenger & Light Truck Tire Owner's Manual & Limited Warranty

MICHELIN® PASSENGER AND LIGHT TRUCK TIRE LIMITED WARRANTY

ABOUT THIS WARRANTY

As the original purchaser of a MICHELIN® passenger or light truck tire, you are covered by all the benefits and conditions (subject to the maintenance recommendations and safety warnings) contained in this booklet. To ensure your understanding of and compliance with the terms and conditions of this warranty, please read it carefully. It is essential that you also read and understand the safety and maintenance recommendations for tires contained in this booklet.

Limited Mileage Warranty:

MICHELIN passenger and light truck tires – replacement and original equipment – are covered by a limited mileage warranty (hereafter referred to as limited warranty for treadwear). For the mileage warranty associated with each tire line, please see your Michelin tire retailer – or visit us at www.michelinman.com/promise.

Certain conditions and limitations apply. Mileage warranties vary by tire line and certain exclusions may apply.

Self-Supporting Tires

Zero Pressure (ZP)

As the purchaser of a MICHELIN® Self-Supporting Zero Pressure (ZP) passenger tire, mounted on a vehicle approved for ZP tires, equipped with a properly operating low tire pressure warning system, you are covered by this warranty. Please pay close attention to the Owner's Manual part of this booklet since it provides specific safety and maintenance information for your ZP tires.

MICHELIN® Self-Supporting Zero Pressure (ZP) tires are part of a very sophisticated system which is designed to provide a very simple benefit: Peace of Mind. With these tires, you can maneuver the vehicle up to 50 miles (80 kilometers) at 55 mph (90 kph), unless otherwise specified in

MICHELIN

your vehicle owner's manual, even though the tire has lost all air! That means time to exit from the highway and get to a place where the tire can be inspected, replaced, or possibly returned to service. The distance that can safely be travelled following an air loss incident will depend upon the conditions under which the vehicle is operating, the degree of air loss, the extent of the damage causing the air loss, the ambient temperature, the load, and the operating speed of the vehicle. The fewer miles you travel after an air loss incident, the greater the likelihood that the tire can be re-inflated (or, if punctured, repaired) and returned to service.

Pax System

The MICHELIN® PAX® System is a very sophisticated system that includes the tire, support ring and gel, pressure sensing device, and wheel. In the event of a loss of tire air pressure, with this system you can still carefully maneuver the vehicle at speeds up to 55 miles per hour, for a distance of up to 125 miles, even though a tire has lost all air! That means time to get off the highway and get to a place where the tire can be inspected, replaced, or possibly repaired and returned to service. That's peace of mind!

MICHELIN® PASSENGER AND LIGHT TRUCK TIRE LIMITED WARRANTY

WHAT IS COVERED AND FOR HOW LONG

Passenger and Light Truck Tires MICHELIN® Passenger and Light Truck tires, used in normal service on the vehicle on which they were originally fitted and in accordance with the maintenance recommendations and safety warnings contained in the attached owner's manual, are covered by this warranty against defects in workmanship and materials for the life of the original usable tread, or 6 years from the date of purchase, whichever occurs first. At that time, all warranties, express or implied, expire. The usable tread is the original tread down to the level of the tread wear indicators - 2/32 nds of an inch (1.6 mm) of tread remaining. Date of purchase is documented by new vehicle registration or tire sales invoice. If no proof of purchase is available, coverage will be based on the date of manufacture.

Replacement will be made in accordance with the terms and conditions described under "How Replacement Charges are Calculated".

NOTE: your vehicle manufacturer may provide additional tire warranty coverage over and above what is provided by Michelin. Consult your vehicle owner's manual for further information.

NOTE: Some MICHELIN® Self-Supporting Zero Pressure (ZP) tires can only be mounted on special SH-M (Symmetric Hump - Modified) wheels. These tires bear the special SH-M designation, molded into the sidewall of the tire, next to the ZP designation. **DO NOT MOUNT A TIRE WITH THE SH-M DESIGNATION ON THE SIDEWALL ON A STANDARD WHEEL. DOING SO VOIDS THIS LIMITED WARRANTY AND COULD CAUSE THE TIRE TO BECOME UNSERVICEABLE AT LOW OR ZERO PRESSURE, RESULTING IN SERIOUS PERSONAL INJURY OR DEATH.**

Treadwear – Mileage Warranty Coverage for MICHELIN® Passenger and Light Truck Tires

MICHELIN® passenger and light truck tires are covered by a manufacturer's limited warranty for treadwear. For the mileage warranty associated with a specific tire line, please see your Michelin tire retailer or visit us at www.michelinman.com/promise. Some vehicles come from the vehicle manufacturer with "split fitments" – meaning different size tires on the front and rear axles. Because these tires cannot be rotated as recommended by Michelin, the mileage warranty on each rear tire will cover half the number of miles as the standard mileage warranty for that particular tire design. Michelin Self-Supporting Zero Pressure (ZP) tires have the same mileage warranty as the standard tire line of which they are a part, up to but not exceeding 30,000 miles. DOT-approved competition tires (e.g., MICHELIN® Pilot® Sport Cup tires) are excluded from any mileage warranty. MICHELIN® Winter tires must be used during winter months only, defined as a period beginning on or after September 1st of a given year and ending no later than April 30th of the following year. MICHELIN winter tires require documentation of the timing of the installation and removal of the tires each winter to maintain coverage under the limited warranty for treadwear.

An important reminder:

No tire manufacturer can guarantee you a certain number of miles from a given tire. Driving habits, driving conditions, road conditions, and vehicle maintenance all play a part in the tread life of a tire. If a tire does not reach the warranted mileage, and the owner of the tires has complied with the terms and conditions of the warranty, Michelin will replace the tires as described under "How Replacement Charges are calculated".

Temporary Spares

MICHELIN® temporary spare tires are covered by this warranty for 6 years from the date of purchase or until the first 2/32 nds of an inch (1.6 mm) of the original tread is worn off. Date of purchase is documented by new vehicle registration or tire sales invoice. If no proof of purchase is available, coverage will be based on date of manufacture. At that time, all warranties, express or implied, expire.

WHAT IS NOT COVERED

Tires which become unserviceable due to:

- Road hazard injury (e.g., a cut, snag, bruise, impact damage or puncture);
- Incorrect mounting of the tire, tire/wheel imbalance or improper repair;
- Misapplication, improper maintenance, racing, underinflation, overinflation or other abuse;
- Uneven or rapid wear which is caused by mechanical irregularity in the vehicle such as wheel misalignment, (a measured tread difference of 2/32 nds of an inch (1.6 mm) or more across the tread on the same tire);
- Accident, fire, chemical corrosion, tire alteration, or vandalism;
- Use in commercial applications for tread wear; by this warranty for 6 years;
- Flat spotting caused by improper storage or brake lock;
- The addition of liquid, solid or gaseous materials other than air, nitrogen or carbon dioxide (for example, waterbase sealers or balancing substances);
- Cosmetic ozone or weather cracking;
- Use of MICHELIN Self-Supporting Zero Pressure (AP) tires without a properly operating low air pressure warning system.

HOW REPLACEMENT CHARGES ARE CALCULATED

Passenger and Light Truck Tires

A tire which becomes unserviceable due to a condition covered by this workmanship and materials limited warranty will be replaced with a comparable new MICHELIN® tire, free of charge, when 2/32nds of an inch (1.6 mm) or less of the original tread is worn, (or 25% or less, whichever is more beneficial to the user) and within 12 months of the date of purchase. Mounting and balancing of the tire is included. **You pay the cost of any other service charges and applicable taxes.** When more than 2/32nds of an inch (1.6 mm) of original tread has been worn (or more than 25%, whichever is more beneficial to the user) or after 12 months from the date of purchase, you must pay the cost of a comparable new MICHELIN® passenger or light truck replacement tire on a pro rata basis. The retailer will determine the charge by multiplying the percentage of the original usable tread worn, by the current selling price at the adjustment location or the price in the current MICHELIN® Base Price List, whichever is lower. This list is based on a predetermined price intended to fairly represent the actual selling price of the tire. **You pay the cost of mounting, balancing and any other service charges and applicable taxes.**

Treadwear

A tire meeting the conditions for pro rata replacement, which wears evenly across the tread, down to the tread wear indicators (2/32nds of an inch tread remaining) within 6 years of the date of purchase, and before delivering the warranted miles of service, will be replaced with a comparable new MICHELIN® tire based on mileage received. The participating MICHELIN® tire retailer will determine the charge by multiplying the percent of mileage received by the current actual selling price at the adjustment location or the price of the tire in the current Michelin Base Price List, whichever is lower. This list is based on a predetermined price intended to fairly represent the actual selling price of the tire. **You pay the cost of mounting, balancing and any other dealer services and applicable taxes.** Tires which wear out evenly before delivering the warranted mileage will be replaced on a pro rata basis only if:

1. You are the original purchaser of the tires, you own the vehicle on which they were originally installed, and the tires have been used only on that vehicle;

MICHELIN

2. The tires have been rotated and inspected by a participating MICHELIN® tire retailer every 7,500 miles, and the attached Mounting and Rotation Service Record has been fully completed and signed;
3. The completed Service Record form, Original Owner/Tire Installation Information form, and the Original Invoice are presented to a participating Michelin tire retailer at the time of adjustment claim; and
4. The tires have not become unserviceable due to a condition listed under.

WHAT IS NOT COVERED

WHAT YOU MUST DO WHEN MAKING A CLAIM When making a claim under the terms of this limited warranty, you must present your tire(s) to a participating Michelin retailer. The vehicle on which the tires were used must be available for inspection. Michelin tire retailers are listed in the yellow pages under "Tire Dealers-Retail". Personal identification (i.e. Driver's License, Credit Card, etc.) and vehicle registration may be required. You pay service charges for normal vehicle and tire maintenance.

CONDITIONS AND EXCLUSIONS

This limited warranty does not provide compensation for loss of time, loss of use of vehicle, inconvenience or incidental or consequential damages. Tires presented for claim remain the property of the consumer and Michelin accepts no responsibility for loss or damage to tires which are in the custody or control of a Michelin tire retailer for the purpose of inspection for warranty adjustment.

In the event of a disputed claim, the consumer must make the tire available for further inspection.

Tires accepted for claim become the property of Michelin North America, Inc.

No Michelin representative, employee or retailer has the authority to make or imply any representation, promise or agreement, which in any way varies from the terms of this warranty.

This warranty applies only in the United States and Canada.

SAFETY MAINTENANCE INFORMATION

Read your Tire Owner's Manual, the information on the sidewall of your tires, your vehicle owner's manual and vehicle tire information placard for essential safety and maintenance information. When service is required:

1. Contact a participating Michelin tire retailer listed in your local yellow pages.
2. If additional assistance in locating a participating Michelin tire retailer is required, please call the phone number listed for your area on page 182.

WARNING!

DISREGARDING ANY OF THE SAFETY PRECAUTIONS AND INSTRUCTIONS CONTAINED IN THIS MANUAL MAY RESULT IN TIRE FAILURE OR EXPLOSION CAUSING SERIOUS PERSONAL INJURY OR DEATH.

ARBITRATION CLAUSE

RESOLUTION OF DISPUTES

ALL CLAIMS ARISING FROM THIS LIMITED WARRANTY OR THE MARKETING, SALE OR PERFORMANCE OF THE PURCHASED PRODUCT AGAINST MICHELIN NORTH AMERICA, INC. AND ITS AGENTS, EMPLOYEES, DEALERS, AFFILIATES, PARENT OR SISTER CORPORATIONS, RELATED CORPORATE ENTITIES, PREDECESSORS, SUCCESSORS OR ASSIGNS (HEREINAFTER COLLECTIVELY "MICHELIN") SHALL BE SUBJECT TO BINDING ARBITRATION. You and Michelin acknowledge your and its right to litigate claims, disputes and controversies arising out of or in connection with this limited warranty or the marketing, sale or performance of the purchased product in court, but prefer to resolve any such claims, disputes and controversies through arbitration and hereby waive the right to litigate such claims, disputes and controversies in court upon election of arbitration by either party. Therefore, you and Michelin agree that all claims, disputes, and controversies between you and Michelin arising out of or in connection with this limited warranty, or any other warranties, express or implied, including a failure of warranty, or any claims arising out of or in connection with the marketing, sale or performance of the purchased product, including but not limited to claims for consumer fraud or

MICHELIN

brought under any consumer protection statute, but excluding claims for personal injury or property damage, shall be finally resolved solely by arbitration, upon election by either party, according to the formal dispute resolution procedures then in effect of the National Arbitration Forum, or if the National Arbitration Forum is no longer conducting such arbitrations, a successor organization thereto or such other private arbitration service as you and Michelin North America, Inc. shall mutually agree (the actual authority involved, the "Arbitral Body"). The Arbitral Body shall decide the issues submitted in accordance herewith, provided that all substantive questions of law will be determined under the laws of the State in which you purchased the product at issue. You agree that no claim subject to arbitration shall be arbitrated as a class action, or on a class-wide or representative basis, or on behalf of the general public, or on behalf of other persons that may be similarly situated. You agree that you do not have the right to act as a private attorney general, a class representative, or to participate as a member of a class of claimants with any claim subject to arbitration. You further agree that no claim subject to arbitration shall be heard by a jury and that any judgment or award of the Arbitral Body will be final and not subject to judicial review. All arbitrations will be conducted as document hearings. Each party shall bear its own costs arising from and associated with the document hearing with MICHELIN the exception of the arbitrator's fee which will be borne by all parties in equal shares. If either party requests any procedures beyond a document hearing, the requesting party will be responsible for all fees, including filing and administrative fees, above and beyond the fees required for document hearings. Any award of the arbitrator(s) may be entered as a judgment and shall be enforceable in any court of competent jurisdiction. The arbitrators will have no authority to award punitive or other damages not measured by the prevailing party's actual damages, except as may be required by statute. Information about arbitration may be obtained and claims may be filed at any office of the National Arbitration Forum or at P.O. Box 50191, Minneapolis, MN 55405.

TIRE DISABLEMENT

SAFETY WARNING

Any tire may fail as a result of an improperly repaired puncture, impact damage, improper inflation, overloading or other conditions resulting from use or misuse. Tire failures, such as a rapid air loss or a tread and belt detachment, may increase risk of injury or death and/or property damage. To reduce the risk of a tire failure, Michelin recommends you

thoroughly read and follow the recommendations in the Michelin Owner's Manual, vehicle owner's manual, tire placard information, and tire sidewall information regarding safety warnings, proper tire use and maintenance.

CONTROLLABILITY

Controlling a vehicle when a tire failure occurs

If a tire failure occurs, you may hear a loud noise, feel a vibration, and/or the vehicle may pull toward the side of the failed tire. If possible, step on the accelerator momentarily to maintain forward momentum and ensure vehicle control. It is most important that you **DO NOT BRAKE OR ABRUPTLY TURN THE STEERING WHEEL**. Slowly remove your foot from the accelerator and hold the steering wheel firmly while steering to remain in your lane. Once the vehicle has slowed and is fully under control, apply the brakes gently; safely pull over to the shoulder and come to a stop. Inspect the tires. If one or more looks flat or low, shows detachment or other damage, remove tire assembly and replace it with a properly inflated spare. Bumps or bulges may indicate detachment within the tire body and require inspection by a qualified tire technician.

DRIVING ON ANY TIRE THAT DOES NOT HAVE THE CORRECT INFLATION PRESSURE IS DANGEROUS

Any underinflated tire builds up excessive heat that may result in sudden tire destruction. If tires are supplied as original equipment, refer to the tire decal on the vehicle (check vehicle and/or vehicle owner's manual for decal location) for the recommended operating pressures. For replacement tires, the correct inflation pressure will be provided by your tire retailer; if not, refer to the vehicle decal.

These inflation pressures must be maintained as a minimum. However, do not exceed the maximum pressure rating indicated on the tire sidewall.

SELF-SUPPORTING TIRES. ZERO PRESSURE (ZP) TIRES, AND PAX SYSTEM TIRES, AT LOW OR ZERO AIR PRESSURE

The handling characteristics of a vehicle with a deflated PAX System tire or Self-Supporting Zero Pressure (ZP) tire (whether front or rear) are not the same as those of a vehicle with normally inflated tires. Avoid high speeds and hard cornering whenever a low pressure warning is activated.

MICHELIN

Even a MICHELIN® PAX® System Tire or Self-Supporting Zero Pressure (ZP) tire can build up excessive heat when run underinflated for an extended period of time. The length of time and distance a PAX System Tire/Self-Supporting Zero Pressure (ZP) tire will perform at low or zero air pressure will depend upon the severity of the event causing air loss, ambient temperature, speed at which the tire is operated, and the conditions under which the tire is operated (i.e. hard braking, cornering and other sharp maneuvers will greatly reduce the length of time the tire can perform at low or zero air pressure.) Continuous use of an underinflated tire may lead to sudden tire destruction. If a tire at low or zero pressure begins to vibrate or cause difficulty in vehicle handling, remove the tire immediately and replace with the temporary spare. If Michelin® PAX System Tire/Self-Supporting Zero Pressure (ZP) tires are supplied as original equipment, refer to the vehicle owner's manual for complete details on the low tire pressure warning system designed to alert you in the event of a low pressure condition.

NOTE: MICHELIN® SELF-SUPPORTING ZERO PRESSURE (ZP) TIRES ARE TO BE USED ONLY IN CONJUNCTION WITH AN OPERATIONAL, MICHELIN® APPROVED, LOW TIRE PRESSURE WARNING SYSTEM. Otherwise, all provisions of the limited warranty are void. For a list of approved systems, see your participating Michelin® tire retailer, or call toll free:1-800-847-3435

NOTE: Some MICHELIN® Self-Supporting Zero Pressure (ZP) tires can only be mounted on special SH-M (Symmetric Hump - Modified) wheels. These tires bear the special SH-M designation, molded into the sidewall of the tire, next to the ZP designation. DO NOT MOUNT A TIRE WITH THE SH-M DESIGNATION ON THE SIDEWALL ON A STANDARD WHEEL. DOING SO VOIDS THIS LIMITED WARRANTY AND COULD CAUSE THE TIRE TO BECOME UNSERVICEABLE AT LOW OR ZERO PRESSURE, RESULTING IN SERIOUS PERSONAL INJURY OR DEATH.

NOTE: MICHELIN® PAX® SYSTEM TIRES ARE TO BE USED ONLY IN CONJUNCTION WITH AN OPERATIONAL, TIRE PRESSURE MONITORING SYSTEM (TPMS), APPROVED BY THE VEHICLE MANUFACTURER FOR USE WITH THE PAX SYSTEM. Otherwise, all provisions of the limited warranty are void. For a list of approved systems, see your authorized PAX System retailer, or call toll free: 1-877-PAX TIRE or 1-877-729-8473

For all types of tires, consult your vehicle tire placard or owner's manual for recommended operating pressures. If the tires are purchased as

replacement tires, operating instructions for the low pressure warning system will be provided by the manufacturer of that system. Recommended operating pressures will be provided by a participating Michelin tire retailer for self supporting ZP tires. Recommended operating pressure for PAX System Tires will be provided by a PAX System retailer. These inflation pressures must be maintained as a minimum. However, do not exceed the maximum pressure rating indicated on the tire sidewall.

CHECK THE COLD INFLATION PRESSURES IN ALL YOUR TIRES, INCLUDING THE SPARE, AT LEAST ONCE EACH MONTH

Failure to maintain correct inflation may result in improper vehicle handling and may cause rapid and irregular tire wear, sudden tire destruction, loss of vehicle control and serious personal injury. Therefore, inflation pressures should be checked at least once each month and always prior to long distance trips. This applies to all tires, including sealant types, and Self-Supporting Zero Pressure (ZP) tires which are as susceptible to losing air pressure as any other type of tire if not properly maintained.

UNDERINFLATION

It is impossible to determine whether tires are properly inflated by simply looking at them. It is almost impossible to “feel or hear” when a tire is being run underinflated or nearly flat. Tires must be checked monthly with a tire pressure gauge.

Pressures should be checked when tires are cold, in other words, before they have been driven on. Driving, even for a short distance, causes tires to heat up and air pressure to increase.

Checking pressure when tires are hot:

If pressures are checked after tires have been driven for more than three minutes or more than one mile, (2 km) the tires become hot and the pressures will increase by approximately 4 psi. Therefore when the tire pressure is adjusted under these conditions, it should be increased to a gauge reading of 4 psi greater than the recommended cold inflation pressure.

For Example Only:

Gauge reading of hot tire:..... 32 psi (220 kPa)

If recommended cold inflation pressure is: 30 psi (205 kPa)

Desired gauge reading of hot tire $30 + 4$ psi = ... 34 psi (205 + 30 = 235 kPa)

Therefore: add 2 psi..... (15 kPa)

Check cold pressure as soon as possible, preferably within 24 hours. "Bleeding" air from hot tires could result in underinflation. Use an accurate tire gauge to check pressures. Never allow children to inflate or deflate tires.

FOR MICHELIN® PAX® SYSTEM TIRES/SELF-SUPPORTING ZERO PRESSURE (ZP) TIRES CHECK INFLATION PRESSURES AS SOON AS POSSIBLE FOLLOWING A LOW PRESSURE WARNING

The PAX® System requires a functioning, correctly calibrated on-board vehicle tire pressure monitoring system (TPMS) to monitor the air pressure and alert the driver when a low pressure event occurs. Be certain to ensure that your vehicle's Tire Pressure Monitoring System (TPMS) is functioning and is correctly calibrated. Refer to your vehicle owner's manual or your vehicle dealer.

Low pressure warning systems are designed to alert the driver to a low air pressure situation in at least one tire on the vehicle. While your ZP tires are designed to provide continued mobility in the event of an air loss, the sooner you respond to a warning and take corrective action, the greater the likelihood that the tire can be returned to service.

Always visually inspect your MICHELIN® PAX® System tire and self-supporting tires and use a pressure gauge to check the air pressure in all 4 tires following any low pressure warning. (Unless advised to do otherwise by the manufacturer of your low pressure warning system.)

If the tire pressure is at or below 18 PSI, proceed to the nearest Authorized PAX System Retailer for PAX tires or a participating Michelin tire retailer for ZP tires (or a representative of your vehicle manufacturer if advised to do so in your vehicle owner's manual) and have the tire demounted and thoroughly inspected for possible internal damage.

If you are unable to see any damage to the tire, and the tire pressure is more than 18 PSI, reinflate your tire to the proper air pressure. (See instructions for checking pressures when tires are hot.) When tires

have cooled, check air pressure again. If any tire has lost more than 5 PSI from the previous pressure check, have the tire inspected at once by an authorized PAX System Retailer for PAX tires or a participating Michelin tire retailer (or representative of your vehicle manufacturer if your vehicle owner's manual so advises.) Failure to do so may cause irreparable damage to the tire and result in sudden tire destruction and personal injury.

TIRE PRESSURE MONITORING SYSTEMS (TPMS):

Your vehicle may be equipped with a Tire Pressure Monitoring System (TPMS) that is designed to monitor the pressure of tires mounted on your vehicle and sends a signal to the driver if a tire pressure falls below a predetermined level. A TPMS should not replace monthly manual pressure checks for all four (4) tires and the spare. We recommend that you manually monitor and check tire pressure inflation with a pressure gauge. Your tires should have the recommended pressure listed by your vehicle's manufacturer. This information can be found in the vehicle owner's manual and often on a placard located in the vehicle's door jamb, inside the fuel hatch, or on the glove compartment door. If you have a plus size fitment that requires a higher inflation pressure, your tire pressure monitoring system will require re-calibration to new inflation pressure. Refer to your tire dealer/installer of plus size tires for proper inflation pressure.

We recommend checking air pressure once each month, and before a long trip. Whether you have a full-sized or mini-spare, make sure that it is properly inflated as well. If the TPMS generates improper monitoring or signals we recommend that you consult your owner's manual provided with your vehicle and follow-up with your vehicle's manufacturer.

TIRE SPINNING

Do not spin wheels in excess of 35 mph (55 km/h) as indicated on the speedometer. Excessive speed in a free-running, unloaded tire can cause it to "explode" from centrifugal force. The energy released by such an explosion is sufficient to cause serious physical injury or death. Never allow anyone to stand near or behind the spinning tire.

When in mud, sand, snow, ice or other slippery conditions, do not engage in excessive wheel spin. Accelerating the motor excessively, particularly with automatic transmission vehicles, may cause a drive tire that has lost traction to spin beyond its speed capability. This is also true when

balancing a drive tire/wheel assembly on the vehicle using the vehicle engine to spin the tire/wheel assembly.

HIGH SPEED DRIVING CAN BE DANGEROUS

Correct inflation pressure is especially important. However, at high speeds, even with the correct inflation pressure, a road hazard, for example is more difficult to avoid and if contact is made, has a greater chance of causing tire damage than at a lower speed. Moreover, driving at high speed reduces the reaction time available to avoid accidents and bring your vehicle to a safe stop. **If you see any damage to a tire or wheel, replace it with the spare at once and visit a participating Michelin Tire Retailer.**

Exceeding the maximum speeds shown on the following page for each type of MICHELIN® tire will cause the tire to build up excessive heat which can cause tire damage that could result in sudden tire destruction and rapid air loss. Failure to control a vehicle when one or more tires experience a sudden air loss can lead to an accident.

In any case, you should not exceed reasonable speeds as indicated by the legal limits and driving conditions.

SPEED RATINGS

Speed Symbols are shown on the sidewall of some MICHELIN® tires. The following table shows the maximum speed corresponding to the symbol.

*Some V (or VR) rated tires may have a speed capacity greater than 149 mph (240 km/h). Consult your participating Michelin® tire retailer for maximum speed rating if your vehicle capability exceeds this speed.

**Z (or ZR) rated tires are designed to use on cars with maximum speed capabilities in excess of 149 mph (240 km/h).

(W and Y speed ratings are subcategories of Z).

Consult your Michelin tire retailer for maximum speed capabilities. For PAX® System Tires consult an authorized PAX System Tire Retailer. Although a tire may be speed-rated, we do not endorse the operation of any vehicle in an unsafe or unlawful manner. Speed ratings are based on laboratory tests which relate to performance on the road, but are not applicable if tires are underinflated, overloaded, worn out, damaged, altered, improperly repaired or retreaded.

Furthermore, a tire's speed rating does not imply that vehicles can be safely driven at the maximum speed for which the tire is rated, particularly under adverse road and weather conditions or if the vehicle has unusual characteristics.

Michelin® highway passenger tires that do not have a speed symbol on the sidewall have a maximum speed rating of 105 mph (170 kph). Light truck highway tires that do not have a speed symbol on the sidewall of the tire have a maximum speed rating of 87 mph (140 kph).

MICHELIN® Winter tires that do not have a speed symbol on the sidewall or tires with Q symbols have a speed rating of 100 mph (160 km/h). Winter tires with a speed symbol have a maximum speed rating in accordance with the symbol.

The speed and other ratings of retreaded tires are assigned by the retreader and replace the original manufacturer's ratings.

IMPORTANT: In order to maintain the speed capability of the vehicle, replacement tires must have speed ratings equal to or higher than those fitted as original equipment (as indicated on the vehicle tire placard or owner's manual). If tires with lower speed ratings are fitted, the vehicle's handling may be affected and the speed capability of the vehicle will be lowered to the maximum speed capability of the replacement tires as indicated in the following table.

REMEMBER...High speed driving can be dangerous and may damage your tires.

AND...When driving at highway speeds, correct inflation pressure is especially important.

SPEED Ratings	Maximum Speed		
	Km/hr	mph	
M	130	81	
N	140	87	
P	150	93	
Q	160	100	
R	170	106	
S	180	112	
T	190	118	
H	210	130	
V	240	149	
V*	240+	149+	
W	270	168	ZR** ↓
Y	300	186	
	300+	186+	

INSPECT YOUR TIRES, DO NOT DRIVE ON A DAMAGED TIRE OR WHEEL

HAZARDS

Objects in the road, such as potholes, glass, metal, rocks, wood, debris and the like, can damage a tire and should be safely avoided. Unavoidable contact with such objects should prompt a thorough tire inspection.

Anytime you see any damage to your tires or wheels, replace with the spare at once and immediately visit any Michelin tire retailer. For PAX® System Tires see an authorized PAX System tire retailer.

IMPACT DAMAGE

A tire impacted by a road hazard (curb, pothole, debris) may be damaged but not have visible signs of damage on its surface. A tire damaged by an impact may sustain a sudden failure a day, week, or even months later. You may not recall hitting an object that damaged or injured your tires. Air loss, unusual tire wear, localized wear or vibrations can also be signs of internal tire damage.

If you suspect any damage to your tire or wheel from an impact with a curb, pothole, debris on the road or any other road hazard, or if you feel or hear any unusual vibration, replace with a properly inflated spare at once and immediately visit any qualified tire technician.

INSPECTION

When inspecting your tires, including the spare, check the air pressures. If the pressure check indicates that one of your tires has lost pressure of two pounds or more, look for signs of penetration, valve leakage or wheel damage that may account for the air loss.

Always look for bulges, cracks, cuts, penetrations, and abnormal tire wear, particularly on the edges of the tire tread, which may be caused by misalignment or underinflation. If any such damage is found, the tire must be inspected by any Michelin tire retailer at once. Use of a damaged tire could result in tire destruction.

All tires will wear out faster when subjected to high speeds as well as hard cornering, rapid starts, sudden stops, frequent driving on roads which are in poor condition, and off road use. Roads with holes and rocks or other objects can damage tires and cause misalignment of your vehicle. When driving on such roads, drive carefully and slowly, and before driving again at normal or highway speeds, examine your tires for any damage, such as cuts, bulges, penetrations, unusual wear patterns, etc.

WEAR BARS

MICHELIN® tires contain “Wear-Bars” in the grooves of the tire tread which show up when only 2/32 nds of an inch (1.6 mm) of tread is remaining. At this stage, your tires must be replaced. Tires worn beyond this stage are extremely dangerous.

DO NOT OVERLOAD - DRIVING ON ANY OVERLOADED TIRE IS DANGEROUS

The maximum load rating of your tires is molded on the tire sidewall. Do not exceed this rating. Follow the loading instructions of the manufacturer of your vehicle and this will ensure that your tires are not overloaded. Tires which are loaded beyond their maximum allowable loads for the particular application will build up excessive heat that may result in sudden tire destruction.

Do not exceed the gross axle weight rating for any axle on your vehicle.

TRAILER TOWING

If you anticipate towing a trailer, you should visit any Michelin tire retailer for advice concerning the correct size tire and pressures. Tire size and pressures will depend upon the type and size of trailer and hitch utilized, but in no case must the maximum cold inflation pressure or tire load rating be exceeded. Check the tire decal and the owner's manual supplied by the manufacturer of your vehicle for further recommendations on trailer towing.

MICHELIN® PAX® System Tires/Self-Supporting Zero Pressure (ZP) Tires and Trailer Towing

Operation of Pax or ZP tires at low or zero air pressure with a trailer in tow, is dangerous and is not recommended. If the low pressure warning indicator is activated when a trailer is in tow, stop, disconnect the trailer, and do not continue to tow the trailer until the tire has been repaired and re-inflated to the proper air pressure. If the tire cannot be repaired, it must be replaced with a new full size, PAX/ZP tire, and inflated to the proper air pressure, before the trailer can be safely towed again.

WHEEL ALIGNMENT AND BALANCING ARE IMPORTANT FOR SAFETY AND MAXIMUM MILEAGE FROM YOUR TIRES.

CHECK HOW YOUR TIRES ARE WEARING AT LEAST ONCE EACH MONTH

If your tires are wearing unevenly, such as the inside shoulder of the tire wearing faster than the rest of the tread, or if you detect excessive vibration, your vehicle may be out of alignment or balance. These conditions not only shorten the life of your tires but adversely affect the handling characteristics of your vehicle, which could be dangerous. If you detect irregular wear or vibration, have your alignment and balance

checked immediately. Tires which have been run underinflated will show more wear on the shoulders than in the center of the tread.

TIRE MIXING

MICHELIN® tires are radial tires and for best performance it is recommended that the same size and type of tire be used on all four wheel positions. Before mixing tires of different types in any configuration on any vehicle, be sure to check the vehicle manufacturer's owner's manual for its recommendations.

It is especially important to check the vehicle manufacturer's owner's manual when mixing, matching, or replacing tires on 4-wheel drive vehicles, as this may require special precautions.

MICHELIN DOES NOT RECOMMEND MIXING PAX® SYSTEM TIRES WITH NON-PAX TIRES / SELF-SUPPORTING ZERO PRESSURE (ZP) TIRES WITH NON-ZP TIRES OTHER THAN THE TEMPORARY USE OF THE SPARE IF THE VEHICLE IS SO EQUIPPED.

WINTER DRIVING

Tires which meet the Rubber Manufacturers Association (RMA) definition of snow tires are marked M/S, or M&S. On such tires, this designation is molded into the sidewall. Tires without this notation are not recommended for winter driving.



While All-Season tires are designed to provide reliable performance in some winter conditions, the use of four (4) winter tires is recommended for optimal performance. Tires designate for use in severe winter conditions are marked on at least one sidewall with the letter "M"

TIRE ROTATION AND REPLACEMENT

To obtain maximum tire wear, it may be necessary to rotate your tires. Refer to your vehicle owner's manual for instructions on tire rotation. If you do not have an owner's manual for your vehicle, Michelin recommends rotating your tires every 6,000 to 8,000 miles (10,000 to 12,000 km).

Monthly inspection for tire wear is recommended. Your tires should be rotated at the first sign of irregular wear, even if it occurs before 6,000 miles (10,000 km). This is true for all vehicles.

MICHELIN

When rotating tires with a directional tread pattern, observe the arrows molded on the sidewall which show the direction the tire should turn. Care must be taken to maintain the proper turning direction.

Some Tire Pressure Monitoring Systems (TPMS) may not recognize that a tire has been moved to a different position on your vehicle. Make certain that your TPMS system is reset, if necessary, so as to correctly identify the location of each tire on your vehicle. Refer to your vehicle owner's manual or your vehicle dealer.

Determine whether rotated tires require tire inflation adjustment as front and rear position tire pressure may vary according to the vehicle manufacturer's specification due to the actual load on that wheel position. Some vehicles may have different sized tires mounted on the front and rear axles, and these different sized tires have rotation restrictions. Always check the vehicle owner's manual for the proper rotation recommendations.

Full-size Spare

Full-size spare tires (not temporary spares) of the same size and construction should be used in a five (5) tire rotation. Always check the inflation pressure of the full-size spare immediately before incorporating it into rotation. Follow the vehicle manufacturer's recommended pattern for rotation, or if not available, see a qualified tire technician.

Replacement of Two (2) Tires

It is recommended that all four (4) tires are replaced at the same time. However, when only two tires are replaced, the new tires should be put on the rear. The new tires, with deeper tread, may provide better grip and water evacuation in wet driving conditions.

CUSTOMIZATION OF TIRES, WHEELS, OR SUSPENSION ON SUVs AND LIGHT TRUCKS

Due to their size, weight and higher center of gravity, vehicles such as SUVs and light trucks do not have the same handling characteristics as automobiles. Because of these differing characteristics, failure to operate your SUV/truck in a proper and safe manner can increase the likelihood of vehicle rollover. Modifications to your SUV/truck tire size, tire type, wheels or suspension can change its handling characteristics and further increase the likelihood of vehicle rollover. Whether your SUV/truck has the original equipment configuration for tires, wheels and suspension or whether any of these items have been modified, always drive safely,

avoid sudden, sharp turns or lane changes and obey all traffic laws. Failure to do so may result in loss of vehicle control leading to an accident and serious injury or death.

TIRE ALTERATIONS

Do not make or allow to be made any alterations on your tires. Alterations may prevent proper performance, leading to tire damage which can result in an accident. Tires which become unserviceable due to alterations such as truing, whitewall inlays, addition of balancing or sealant liquids, or the use of tire dressing containing petroleum distillates are excluded from warranty coverage.

REPAIRS WHEREVER POSSIBLE, SEE YOUR MICHELIN® TIRE RETAILER AT ONCE

If any MICHELIN® tire sustains a puncture, have the tire demounted and thoroughly inspected by any Michelin tire retailer for possible damage that may have occurred. A tread area puncture in any MICHELIN® passenger or light truck tire can be repaired provided that the puncture hole is not more than 1/4" in diameter, not more than one radial cable per casing ply is damaged, and the tire has not been damaged further by the puncturing object or by running underinflated. Tire punctures consistent with these guidelines can be repaired by following the Rubber Manufacturers Association (RMA) recommended repair procedures.

TIRE REPAIRS

Repairs of all tires must be of the combined plug and inside patch type. Your MICHELIN® PAX® System tires must be removed from the wheel for inspection prior to repair. Plug only repairs are improper. A tire should be removed from the rim and inspected prior to repair. Any tire repair done without removing the tire from the rim is improper. An improperly repaired tire will cause further damage to the tire by either leaking air or allowing air, moisture and contaminants to enter the structure of the tire. An improperly repaired tire can fail suddenly at a later date.

Never repair a tire with less than 2/32nds of an inch tread remaining. At this tread depth, the tire is worn out and must be replaced.

STORAGE

Tires contain waxes and emollients to protect their outer surfaces from ozone and weather checking. As the tire rolls and flexes, the waxes and emollients continually migrate to the surface, replenishing this protection throughout the normal use of the tire. Consequently, when tires sit outdoors, unused for long periods of time (a month or more) their surfaces become dry and more susceptible to ozone and weather checking and the casing becomes susceptible to flat spotting. **For this reason, tires should always be stored in a cool, dry, clean, indoor environment. If storage is for one month or more, eliminate the weight from the tires by raising the vehicle or by removing the tires from the vehicle. Failure to store tires in accordance with these instructions could result in damage to your tires or premature aging of the tires and sudden tire failure.**

When tires are stored, be sure they are placed away from sources of heat and ozone such as hot pipes and electric generators. Be sure that surfaces on which tires are stored are clean and free from grease, gasoline or other substances which could deteriorate the rubber. **(Tires exposed to these materials during storage or driving could be subject to sudden failure.)**

FOLLOW THESE MOUNTING RECOMMENDATIONS

Tire changing can be dangerous and must be done by professionally trained persons using proper tools and procedures as specified by the Rubber Manufacturers Association (RMA). PAX® System tires must be mounted and dismounted only by specially trained, authorized PAX System retailers, utilizing PAX System authorized equipment.

Your tires should be mounted on wheels of correct size and type and which are in good, clean condition. Wheels that are bent, chipped, rusted (steel wheels) or corroded (alloy wheels) may cause tire damage. The inside of the tire must be free from foreign material. Have your retailer check the wheels before mounting new tires. Mismatched tires and rims can explode during mounting. Also, mismatched tires and rims can result in dangerous tire failure on the road. If a tire is mounted by error on the wrong-sized rim, do not remount it on the proper rim scrap it. It may have been damaged internally (which is not externally visible) by having been dangerously stretched and could fail on the highway.

Old valves may leak. When new tubeless tires are mounted, have new valves of the correct type installed. Tubeless tires must only be mounted on wheels designed for tubeless tires i.e., wheels which have

safety humps or ledges. As with any other tire air valve, the PAX® System valve stem-pressure sensor combination must be in good condition to assure its performance. Always utilize valve caps capable of containing the tire's air pressure, should the valve core leak. The valve cap is the primary seal against air loss.

It is recommended that you have your tires and wheels balanced. Tires and wheels which are not balanced may cause steering difficulties, a bumpy ride, and irregular tire wear.

SPECIAL MOUNTING INSTRUCTIONS FOR PAX® SYSTEM TIRES

PAX System wheels are different from all other wheels. Never attempt to mount a non-PAX System tire on a PAX System wheel, or a PAX® System tire on a non-PAX System wheel. Attempting to do so could cause serious injury or death. All PAX System components (tire, wheel, support ring, pressure sensor and gel) must be utilized. Never utilize a PAX System tire and wheel without every other properly functioning component part, correctly installed by an Authorized PAX System retailer. The PAX System must be used on all wheel positions.

After a low or zero pressure driving event, the PAX System tire and wheel may be hot to the touch. **Always allow a PAX® System tire to cool before attempting to handle it. Failure to do so could result in injury.**

SPECIAL MOUNTING INSTRUCTIONS FOR SELF-SUPPORTING ZERO PRESSURE™ (ZP) TIRES

ZP tires can be more difficult to mount than conventional tires. They should be mounted and demounted only by a properly trained tire professional. ZP tires can generate a tremendous amount of heat when run at low or zero pressure. **ALWAYS ALLOW A ZP TIRE TO COOL BEFORE ATTEMPTING TO HANDLE IT. FAILURE TO DO SO COULD RESULT IN INJURY.**

MICHELIN® ZP tires are tubeless tires designed to operate in emergency conditions at low or zero air pressure.

MICHELIN® SELF SUPPORTING Zero Pressure (ZP) TIRES AND SPECIAL SH-M (SYMMETRIC HUMP-MODIFIED) WHEELS

Some MICHELIN® ZP tires can only perform with zero pressure capability when mounted on special SH-M wheels. These tires bear the SH-M designation immediately following the ZP designation on the

MICHELIN

sidewall of the tire. DO NOT MOUNT ZP TIRES WITH THE SH-M DESIGNATION ON STANDARD WHEELS. IN SUCH APPLICATIONS, THE TIRES MAY BECOME UNSERVICEABLE AT LOW OR ZERO PRESSURE, CAUSING SERIOUS PERSONAL INJURY OR DEATH.

SPECIAL MOUNTING INSTRUCTIONS FOR MICHELIN® TRX™ TIRES

The MICHELIN® TRX™ tire is a tubeless tire that must only be mounted on special wheels (TR or JM type) with millimetric seat diameter. If TRX tires are mounted on standard wheels, they will not retain air due to an air escape feature designed into the bead area of these tires.

Do not try to override this feature by mounting TRX tires with tubes. The MICHELIN® TRX tire must be used on all wheel positions.

TEMPORARY TYPE SPARE TIRES

When using any temporary type spare tire, be sure to follow the vehicle manufacturer's instructions.

READING THE DOT

DOT XXXX XXXX XXX (prior to August 2000)

DOT XXXX XXXX XXX (1990-1999)

DOT XXXX XXXX XXXX (after July 2000)

THE DOT

The "DOT" symbol certifies tire manufacturer's compliance with U.S. Department of Transportation tire safety standards. Next to the symbol is the tire identification or "serial number". The first two characters identify the plant where the tire was manufactured. The next two characters reflect the tire size. The following one to four digits may be used at the tire manufacturer's option as a descriptive code. The last three characters are numbers identifying the week and year of manufacture. (Example: "O25" means second week of the year of decade, eg.: 1995, 1985, etc.) For the 1990-1999 decade MICHELIN® brand tires are marked with a triangle pointing to the last three numeric characters. Tires produced after July 2000 have an additional digit to identify a given decade. For example, 2800 means the tire was produced during the 28th week of 2000; 0201 during the 2nd week of 2001. If the last digits of your DOT number contains three numeric characters and is not marked with a triangle, consult a qualified tire technician to determine the year of manufacture.

SERVICE LIFE FOR PASSENGER CAR AND LIGHT TRUCK TIRES INCLUDING SPARE TIRES

The following recommendation applies to passenger car and light truck tires. Tires are composed of various types of material and rubber compounds, having performance properties essential to the proper functioning of the tire itself. These component properties evolve over time. For each tire, this evolution depends upon many factors such as weather, storage conditions, and conditions of use (load, speed, inflation pressure, maintenance etc.) to which the tire is subjected throughout its life. This service-related evolution varies widely so that accurately predicting the serviceable life of any specific tire in advance is not possible.

That is why, in addition to regular inspections and inflation pressure maintenance by consumers, it is recommended to have passenger car and light truck tires, including spare tires, inspected regularly by a qualified tire specialist, such as a tire dealer, who will assess the tire's suitability for continued service. Tires which have been in use for 5 years or more should continue to be inspected by a specialist at least annually. Consumers are strongly encouraged to be aware not only of their tires' visual condition and inflation pressure but also of any change in dynamic performance such as increased air loss, noise or vibration, which could be an indication that the tires need to be removed from service to prevent tire failure. It is impossible to predict when tires should be replaced based on their calendar age alone. However the older a tire the greater the chance that it will need to be replaced due to the service-related evolution or other conditions found upon inspection or detected during use.

While most tires will need replacement before they achieve 10 years, it is recommended that any tires in service 10 years or more from the date of manufacture, including spare tires, be replaced with new tires as a simple precaution even if such tires appear serviceable and even if they have not reached the legal wear limit. For tires that were on an original equipment vehicle (i.e., acquired by the consumer on a new vehicle), follow the vehicle manufacturer's tire replacement recommendations, when specified (but not to exceed 10 years).

The date when a tire was manufactured is located on the sidewall of each tire. Consumers should locate the Department of Transportation or DOT code on the tire which begins with DOT and ends with the week and year of manufacture. For example, a DOT code ending with "2204" indicates a tire made in the 22nd week (May) of 2004.

REMEMBER... TO AVOID DAMAGE TO YOUR TIRES AND POSSIBLE ACCIDENT:

- CHECK TIRE PRESSURE AT LEAST ONCE EACH MONTH WHEN TIRES ARE COLD AND BEFORE LONG TRIPS.
- DO NOT UNDERINFLATE/OVERINFLATE.
- DO NOT OVERLOAD.
- DRIVE AT MODERATE SPEEDS, OBSERVE LEGAL LIMITS.
- AVOID DRIVING OVER POTHoles, OBSTACLES, CURBS OR EDGES OF PAVEMENT.
- AVOID EXCESSIVE WHEEL SPINNING.
- IF YOU SEE ANY DAMAGE TO A TIRE, REPLACE WITH THE SPARE AND VISIT ANY MICHELIN® TIRE RETAILER AT ONCE.
- IF YOU HAVE ANY QUESTIONS. CONTACT YOUR MICHELIN TIRE RETAILER.

FAILURE TO OBSERVE ANY OF THE RECOMMENDED PRECAUTIONS CONTAINED IN THIS OWNER'S MANUAL CAN LEAD TO ERRATIC VEHICLE BEHAVIOR AND/OR TIRE DAMAGE, POSSIBLY RESULTING IN AN ACCIDENT.

If you see any damage to your tires or wheels, contact your local participating Michelin® tire retailer listed in the Yellow Pages, or visit our web site listed below for dealer locations. If further assistance is required, contact:

IN USA 1-800-847-3435 or write:

Michelin North America, Inc.
Attention: Consumer Care Department
Post Office Box 19001
Greenville, SC 29602-9001
or visit: www.michelinman.com.

IN CANADA 1-888-871-4444 or write:

Michelin North America (Canada) Inc.
3020 Jacques-Bureau Avenue
Laval, Quebec
H7P 6G2
or visit: www.michelin.ca.

MOUNTING AND ROTATION SERVICE RECORD (For Mileage Limited Warranties Only)

Installed Mileage _____

DATE OF ROTATION	ODOMETER READING	RETAILER'S NAME AND ADDRESS	RETAILER SIGNATURE	PSI (check)

To validate the mileage portion of this warranty, your tires must be inspected and rotated every 7,500 miles and the PSI set as recommended on the vehicle placard.
Owner Certification: I hereby certify that these services were performed as indicated and that I am the original purchaser of the tires and the owner of the vehicle on which they were originally installed and exclusively used.

Consumer Signature _____ Date _____

ORIGINAL OWNER/TIRE INSTALLATION INFORMATION To be completed at time of purchase

Date of Purchase: _____ Make/Model: _____
 Vehicle odometer reading when tires installed: _____

Customer Information:
 Name: _____
 Address: _____
 City: _____ State: _____ Zip Code: _____
 Recommended Tire Pressure Front: _____ PSI
 Recommended Tire Pressure Rear: _____ PSI
 DOT No.: _____ Tire #1: _____
 _____ Tire #2: _____
 _____ Tire #3: _____
 _____ Tire #4: _____

Phone No.: _____
 Vehicle Information:
 Year: _____

TIRE REMOVAL INFORMATION

Odometer reading _____ Date _____ Retailer _____
 when tires removed: _____ Removed: _____ Name: _____ Signature: _____

MICHELIN® NORTH AMERICA, INC., P.O. BOX 19001, GREENVILLE, SOUTH CAROLINA 29602-9001

AN EQUAL OPPORTUNITY EMPLOYER

NEXEN TIRE

TOTAL COVERAGE WARRANTY™

(Effective February 1, 2016)

FOR STEEL BELTED RADIAL TIRES MANUFACTURED BY NEXEN TIRE

ABOUT NEXEN TOTAL COVERAGE WARRANTY

This limited warranty only applies to the original purchaser of new replacement tires sold by NEXEN TIRE USA (as below NEXEN TIRE), and has been used on the same vehicle that it was originally installed on.

This warranty applies to tires purchased after February 1st 2016. Tires purchased before February 1st 2016 are subject to the previous published warranty.

The Nexen Total Coverage Warranty offers the consumer the following benefits:

Coverage for Defects in Workmanship and Materials

- Mileage Tread Wear Limited Warranty*
- Road Hazard Replacement Program*
- Roadside Assistance – Flat Tire Change or Tow Service

*Most, but not all Nexen Tire patterns come with a Mileage Tread Wear Warranty and/or Road Hazard Replacement. Check each pattern for coverage.

For purposes of this warranty, the term “usable tread life” will be determined as having at least 2/32” (1.6 mm) of tread remaining evenly across the tire. If less than 2/32” (1.6 mm) of tread remains at any point on the face of the tire, the tire will be considered past its usable tread life and subject to any and all conditions stated below.

WORKMANSHIP AND MATERIALS

All NEXEN tires are warranted against defects in workmanship and material and will be replaced 100% free of charge for the initial warranty period which is the first 2/32” (1.6 mm) of original usable tread life, or within 12 months from the period of purchase, whichever comes first.

NEXEN TIRE

After the 100% replacement term expires and the tire is still within 72 months from date of manufacture, the amount of credit will be determined by the percentage of original tread depth remaining on the tire. Under all circumstances, the cost of mounting, balancing and any other service charges including applicable taxes are required to be paid by the consumer.

MILEAGE TREAD WEAR LIMITED WARRANTY

Most patterns manufactured by NEXEN TIRE are assigned a mileage warranty that protects the consumer against premature tread wear. If a tire reaches the end of its “usable tread life” before the stated mileage warranty, the consumer will be issued a replacement Nexen tire on a pro rata basis, which means the consumer will be responsible for a percentage of the replacement cost. In order to maintain tread wear warranty, all tires must be rotated at least every 5,000-6,000 miles (8,000-10,000 km). Under all circumstances, the cost of mounting, balancing and any other service charges including applicable taxes are required to be paid by the consumer.

WHAT IS NOT COVERED UNDER THIS LIMITED WARRANTY

- Ride complaints after the first 2/32” of tread wear or replacement of 3 or more tires from the same vehicle will not be accepted.
- Road hazard damage such as cuts, snags, punctures or tire repair, bruises, impact breaks, etc. (Check Road Hazard Replacement Program for patterns that are covered against this type of damage).
- Premature or irregular wear due to vehicle mechanical deficiencies or failure to rotate the tires at recommended intervals.
- Tires on any vehicle registered and normally operated outside the United States.
- Damage from incorrect mounting or dismounting of the tire, incorrect application, water or other material trapped inside the tire during mounting or failure to balance the tires.
- Damage from over or under inflation, overloading, fire, theft, and defective vehicle mechanical conditions.
- Racing, off road use and misapplications of tire to vehicle.
- Ozone or weather cracking on tires after 48 months from the date of manufacture or other abuse, misuse, tire alteration, run flat.

- Any tires worn beyond the wear indicators. (Less than 2/32" remaining tread depth). remaining tread depth).
- Flat spotting caused by improper storage or brake lock.
- Accident, fire, chemical corrosion, tire alteration or vandalism.
- Tire which D.O.T. identification number and/or brand name removed intentionally.
- Loss of time or use, inconvenience or any incidental or consequential damage.
- Original equipment tires on new vehicle. (See separate warranty, if applicable, in your vehicle's glove box.)
- Tires purchased as used.
- Tires used on Recreational Vehicles (For camping & Motor homes, etc.) or in commercial service.

OTHER LIMITATIONS INCLUDE BUT ARE NOT LIMITED TO THE FOLLOWING:

- Failure to rotate tires as recommended voids the tread wear warranty.
- If tires are different size on front and rear of vehicle, and therefore can't be rotated, the mileage warranty for the rear tires will be half of the stated mileage warranty.
- Winter tires must be used only in winter months, which are determined to be September 1st through April 30th of the following year. Documentation is required showing date of installation and removal to maintain tread wear warranty.

ROAD HAZARD REPLACEMENT PROGRAM

Most patterns sold by NEXEN TIRE are covered by a road hazard warranty that protects the consumer against non-repairable damage caused by puncture, snag, cut, bruise or impact break. Typical road hazards are nails, glass, potholes and other debris. Covered tires will be eligible for a free replacement for the first 3/32" of original tread depth, or for a period of two years from the date of purchase; whichever comes first. If the DOT # on the tire is greater than 2 years from the adjustment date, an invoice showing date of purchase is necessary. The cost of mounting, balancing and any other service charges including applicable taxes are required to be paid by the consumer.

NEXEN TIRE

WHAT IS NOT COVERED UNDER THE ROAD HAZARD REPLACEMENT PROGRAM

- A tire that is damaged due to vandalism.
- A tire that is damaged due to an accident.
- A tire that is repairable under Rubber Manufacturers Association (RMA) standards.
- A tire that has failed due to commercial use.
- A tire that is damaged or failed due to racing or off road use.
- A tire that is damaged due to use of snow chains or studs.
- A tire that is damaged or failed due to irregular wear caused by mechanical issues.
- Original equipment tires on new vehicle.
- Tires transferred from the vehicle that they were originally installed.

CONSUMER'S OBLIGATION WHEN FILING CLAIM

To maintain Mileage Tread Wear Warranty and Road Hazard Replacement Program, the consumer is responsible for the following:

- Any claims must be presented to an authorized NEXEN TIRE dealer.
- Submit or present a copy of the original purchase receipt with documented automobile mileage at time of tire installation and of tire dismounting.
- Submit a tire rotation record showing that all tires have been rotated at least every 5,000-6,000 miles (8,000-10,000 km). Tire rotation record is not necessary for Mileage claims when tire is within 2/32" difference of remaining tread depth as measured from shoulder to shoulder on the claim tire, and compared to the remaining tread depth of the opposite front/rear or left/right tire.
- Complete and sign the NEXEN TIRE Claim Adjustment form provided by the dealer, keep a copy for your records and leave the tire with the dealer for warranty processing.

ROADSIDE ASSISTANCE

Patterns sold after May 1st 2014 by NEXEN TIRE in the United States and Canada are eligible for a free 24/7/365 Roadside Assistance for a period of 36 months from the purchase date. Upon purchasing Nexen tires, the consumer will receive an activation card from the tire shop. An online registration needs to be completed in order to have access to a toll free phone number to call in case of a flat tire. A qualified professional will change your flat tire with your spare tire free of charge. If a working spare is not available, towing will be provided free of charge to the nearest NEXEN TIRE dealer or authorized place of repair.

*Nexen Tire reserves the right to change the terms and conditions of all warranties at any time.

TIRE CARE AND MAINTENANCE GUIDE

Tire failure can result in serious damage and/or personal injury. To reduce the risk of tire failure we recommend the following:

- Maintain proper inflation pressure and do not use at under inflation or over inflation. Pressure should be set at the level recommended by vehicle manufacturer.
- Wheel alignment and balancing should be checked at regular intervals.
- Do not overload. The maximum load carrying capacity is molded on the sidewall of the tire.
- Do not spin your tires excessively and avoid driving over curbs, potholes, obstacles and edges of pavement.
- Never drive on smooth (bald) tires. By law, tires must be replaced when 2/32" of tread depth remained, as indicated by tread wear indicator molded in the tread grooves.
- Check your tires frequently for any scrapes, cuts, foreign objects, separations or bulges. If damage is found, do not attempt to dismount a tire yourself. Change damaged tire with the spare and contact your local authorized NEXEN TIRE dealer immediately.
- Do not drive in excess of speed limits allowed by law or the maximum speed justified by driving conditions.
- To achieve proper even wear and gain maximum tread life, tire rotation at regular intervals is required.

NEXEN TIRE

For more information or service regarding NEXEN TIRE, please contact your nearest Authorized NEXEN Dealer.

For more information, please call the toll-free technical support number:
1-800-57-NEXEN 1-800-576-3936 / 1-866-70-NEXEN 1-866-706-3936

NEXEN TIRE AMERICA INC.

21073 Pathfinder Road Suite 100 Diamond Bar, CA 91765

Toll Free Number

1-800-57-NEXEN 1-800-576-3936 / 1-866-70-NEXEN 1-866-706-3936

FAX: 1-909-781-6590 / 1-909-923-3991

www.NexenTireUSA.com

MILEAGE WARRANTY ADJUSTMENT TABLE

Mileage up to	Percent customer pays per original warranty mileage									
	25,000	30,000	35,000	40,000	50,000	55,000	60,000	65,000	70,000	80,000
1,000	4%	3%	3%	3%	2%	2%	2%	2%	1%	1%
2,000	8%	7%	6%	5%	4%	4%	3%	3%	3%	3%
3,000	12%	10%	9%	8%	6%	5%	5%	5%	4%	4%
4,000	16%	13%	11%	10%	8%	7%	7%	6%	6%	5%
5,000	20%	17%	14%	13%	10%	9%	8%	8%	7%	6%
6,000	24%	20%	17%	15%	12%	11%	10%	9%	9%	8%
7,000	28%	23%	20%	18%	14%	13%	12%	11%	10%	9%
8,000	32%	27%	23%	20%	16%	15%	13%	12%	11%	10%
9,000	36%	30%	26%	23%	18%	16%	15%	14%	13%	11%
10,000	40%	33%	29%	25%	20%	18%	17%	15%	14%	13%
11,000	44%	37%	31%	28%	22%	20%	18%	17%	16%	14%
12,000	48%	40%	34%	30%	24%	22%	20%	18%	17%	15%
13,000	52%	43%	37%	33%	26%	24%	22%	20%	19%	16%
14,000	56%	47%	40%	35%	28%	25%	23%	22%	20%	18%
15,000	60%	50%	43%	38%	30%	27%	25%	23%	21%	19%
16,000	64%	53%	46%	40%	32%	29%	27%	25%	23%	20%
17,000	68%	57%	49%	43%	34%	31%	28%	26%	24%	21%
18,000	72%	60%	51%	45%	36%	33%	30%	28%	26%	23%
19,000	76%	63%	54%	48%	38%	35%	32%	29%	27%	24%
20,000	80%	67%	57%	50%	40%	36%	33%	31%	29%	25%
21,000	84%	70%	60%	53%	42%	38%	35%	32%	30%	26%
22,000	88%	73%	63%	55%	44%	40%	37%	34%	31%	28%
23,000	92%	77%	66%	58%	46%	42%	38%	35%	33%	29%
24,000	96%	80%	69%	60%	48%	44%	40%	37%	34%	30%
25,000	100%	83%	70%	63%	50%	45%	42%	38%	36%	31%
26,000		87%	74%	65%	52%	47%	43%	40%	37%	33%
27,000		90%	77%	68%	54%	49%	45%	49%	39%	34%
28,000		93%	80%	70%	56%	51%	47%	42%	40%	35%
29,000		97%	83%	73%	58%	53%	48%	43%	41%	36%
30,000		100%	86%	75%	60%	55%	50%	45%	43%	38%
31,000			89%	78%	62%	56%	52%	46%	44%	39%
32,000			91%	80%	64%	58%	53%	48%	46%	40%
33,000			94%	83%	66%	60%	55%	49%	47%	41%
34,000			97%	85%	68%	62%	57%	51%	49%	43%
35,000			100%	88%	70%	64%	58%	52%	50%	44%
36,000				90%	72%	65%	60%	54%	51%	45%
37,000				93%	74%	67%	62%	55%	53%	46%
38,000				95%	76%	69%	63%	57%	54%	48%
39,000				98%	78%	71%	65%	58%	56%	49%
40,000				100%	80%	73%	67%	60%	57%	50%

Mileage up to	Percent customer pays per original warranty mileage					
	50,000	55,000	60,000	65,000	70,000	80,000
41,000	82%	75%	68%	63%	59%	51%
42,000	84%	76%	70%	65%	60%	53%
43,000	86%	78%	72%	66%	61%	54%
44,000	88%	80%	73%	68%	63%	55%
45,000	90%	82%	75%	69%	64%	56%
46,000	92%	84%	77%	71%	66%	58%
47,000	94%	85%	78%	72%	67%	59%
48,000	96%	87%	80%	74%	69%	60%
49,000	98%	89%	82%	75%	70%	61%
50,000	100%	91%	83%	77%	71%	63%
51,000		93%	85%	78%	73%	64%
52,000		95%	87%	80%	74%	65%
53,000		96%	88%	82%	76%	66%
54,000		98%	90%	83%	77%	68%
55,000		100%	92%	85%	79%	69%
56,000			93%	86%	80%	70%
57,000			95%	88%	81%	71%
58,000			97%	89%	83%	73%
59,000			98%	91%	84%	74%
60,000			100%	92%	86%	75%
61,000				94%	87%	76%
62,000				95%	89%	78%
63,000				97%	90%	79%
64,000				98%	91%	80%
65,000				100%	93%	81%
66,000					94%	83%
67,000					96%	84%
68,000					97%	85%
69,000					99%	86%
70,000					100%	88%
71,000						89%
72,000						90%
73,000						91%
74,000						93%
75,000						94%
76,000						95%
77,000						96%
78,000						98%
79,000						99%
80,000						100%

WARRANTY INFORMATION PER TIRE

Mileage up to	Percent customer pays per original warranty mileage					
	50,000	55,000	60,000	65,000	70,000	80,000
41,000	82%	75%	68%	63%	59%	51%
42,000	84%	76%	70%	65%	60%	53%
43,000	86%	78%	72%	66%	61%	54%
44,000	88%	80%	73%	68%	63%	55%
45,000	90%	82%	75%	69%	64%	56%
46,000	92%	84%	77%	71%	66%	58%
47,000	94%	85%	78%	72%	67%	59%
48,000	96%	87%	80%	74%	69%	60%
49,000	98%	89%	82%	75%	70%	61%
50,000	100%	91%	83%	77%	71%	63%
51,000		93%	85%	78%	73%	64%
52,000		95%	87%	80%	74%	65%
53,000		96%	88%	82%	76%	66%
54,000		98%	90%	83%	77%	68%
55,000		100%	92%	85%	79%	69%
56,000			93%	86%	80%	70%
57,000			95%	88%	81%	71%
58,000			97%	89%	83%	73%
59,000			98%	91%	84%	74%
60,000			100%	92%	86%	75%
61,000				94%	87%	76%
62,000				95%	89%	78%
63,000				97%	90%	79%
64,000				98%	91%	80%
65,000				100%	93%	81%
66,000					94%	83%
67,000					96%	84%
68,000					97%	85%
69,000					99%	86%
70,000					100%	88%
71,000						89%
72,000						90%
73,000						91%
74,000						93%
75,000						94%
76,000						95%
77,000						96%
78,000						98%
79,000						99%
80,000						100%

TIRE SERVICE RECORD

Please ensure that your dealer completes the information below at the recommended service interval.

Date of Rotation	Odometer Reading	Dealer Name & Address	Air Pressure

PIRELLI TIRES

PIRELLI ORIGINAL EQUIPMENT & REPLACEMENT LIMITED WARRANTY PASSENGER & LIGHT TRUCK TIRES

What Is Warranted and Who Is Eligible Under the Warranty?

Pirelli Tire Inc. (PTI), 1111, Boul. Dr. Frederik-Philips, suite 506, St.Laurent, Quebec, H4M 2X6, warrants to the original purchaser that all Pirelli brand or PTI private brand Original Equipment and Replacement Passenger and Light Truck radial tires with a complete D.O.T. identification number and branded Pirelli or a PTI private brand, which are supplied by PTI, either directly or through an authorized Pirelli Dealer, and which are mounted on passenger cars, vans and light trucks within the U.S.A. and Canada will be free from defects in workmanship and materials. The Pirelli Original Equipment & Replacement Limited Warranty is subject to periodic revision: see the Warranty section at www.ca.pirelli.com for the latest version.

Original Equipment and Replacement Tires

Original Equipment Tires are defined as tires supplied as original equipment by the vehicle manufacturer on new vehicles. Original Equipment tires are backed by Workmanship and Materials coverage. The PTI Limited Tread wear warranty does not apply to Original Equipment tires.

Replacement Tires are defined as tires mounted to your vehicle after the Original Equipment tires have been removed. Replacement Tires are backed by both Workmanship and Materials and PTI Limited Tread wear coverage as defined in this document.

Tire Registration

Please request your dealer register your replacement tires, provide you with a registration card, or go to www.ca.pirelli.com to register your tires on line. In case of a tire recall, we can reach you only if we have your name and address. You must register your tires to be on our list.

What Is The Adjustment Policy And For How Long?

If a Pirelli tire becomes unserviceable due to workmanship or material anomalies during the initial warranty period, which is one year from the date of original retail purchase of the vehicle or purchase of replacement tires (purchase receipt required) or within the first 2/32" of the original usable tread, whichever occurs first, the tire will be replaced with the same or comparable tire at no charge to the owner. To receive consideration for warranty coverage, tires must be returned to a PTI authorized dealer. Tire Inspection Personnel designated by PTI make the final determination regarding qualification for Workmanship and Materials and Limited Tread wear coverage on tires submitted to Pirelli via an authorized Pirelli dealer. If the tire is presented for ride related anomalies the warranty period is one year from the date of original retail purchase of the vehicle or purchase of replacement tires (purchase receipt required) or within the first 2/32" of the original usable tread, whichever occurs first. The owner must pay for any associated service charges, including costs associated with mounting and balancing in both the aforementioned cases.

After the initial warranty period, if a Pirelli tire becomes unserviceable due to workmanship or material anomalies the owner must pay the cost for a comparable new Pirelli brand or PTI private brand replacement tire on a pro-rata basis. The authorized Pirelli Dealer will determine the cost by multiplying the percentage of the original usable tread worn by the current dealer selling price. The owner must pay for any associated service charges, including costs associated with mounting and balancing of the tire.

A tire has delivered its original usable tread life and is considered 100% worn when the tread wear indicators (2/32" tread remaining) become visible regardless of age or mileage.

Pirelli Confidence *Plus* Program™

Select Pirelli tires are covered by a 30 day trial period. At any time during the 30 day period if you are not satisfied with any of the qualifying lines listed below, the set of four tires with the original sales receipt may be returned to the authorized Pirelli dealer from which they were purchased and may be exchanged for a set of Pirelli tires for equal or lesser value.

Tire lines which qualify for Pirelli Confidence *Plus* Program *Plus Plus Plus*

Refer to www.ca.pirelli.com for details regarding terms and conditions of the Pirelli Confidence *Plus* Program.

Limited Treadwear Warranty For Replacement Tires Only

In addition to the above workmanship and materials warranty PTI also warrants to the original consumer purchaser only, that the tread life of Cinturato P3000™, P4 Four Seasons , P4 Four Seasons *Plus* , Cinturato P5™, P6™ Four Seasons *Plus Plus* , Pirelli P Zero All Season *Plus* , P Zero Nero™ All Season, Scorpion™ ATR, Scorpion STR and Scorpion Verde All Season *Plus* replacement street legal tires which are supplied by PTI either directly or through an authorized Pirelli dealer, will have treadwear warranty coverage for the described vehicle odometer kilometers from the point of original retail purchase. The authorized Pirelli Dealer will determine the replacement tire cost by multiplying the percentage of the mileage obtained by the current dealer selling price.

The PTI Treadwear Mileage Warranty Conditions:

- You are the original purchaser of the tires and have a copy of the original invoice showing the application mileage.
- You are the owner of the vehicle on which the tires were originally installed.
- The tires are Replacement tires (The PTI Treadwear Mileage Warranty does not apply to Original Equipment tires).
- You have had the tires rotated every 8,000 to 11,000 kilometers.

PIRELLI TIRES

- The tires are worn evenly across the tread, down to the treadwear indicator (2/32”) at which time they are considered to be 100% worn out. There cannot be more than a 2/32” tread depth difference across the tire.
- Your servicing Pirelli Dealer has completed the Tire Rotation Record.
- PTI Mileage Warranty does not apply to Original Equipment fitments.
- Passenger and P-Metric Light Truck tires are not covered for mileage when used on commercial vehicles or in commercial applications.
- Mileage warranty does not apply to Euro-metric tires purchased before July 1, 2011.
- For vehicles equipped with staggered size fitments (different tire sizes front and rear), the mileage warranty for the rear tires will be 50% of the stated mileage warranty for that line.
- Run Flat tires will have a mileage warranty of 50% of the stated mileage warranty for that line, not to exceed 50,000 kilometers, whichever is lower.

Mileage Warranty

Tire Line	Kilometers
Cinturato P3000	135,000
P4 Four Seasons T	135,000
P4 Four Seasons H	105,000
P4 Four Seasons <i>Plus</i> T	145,000
P4 Four Seasons <i>Plus</i> H	110,000
Cinturato P5 T	135,000
Cinturato P5 H	105,000
P6 Four Seasons <i>Plus</i>	75,000
Cinturato P7 All Season <i>Plus</i>	110,000
P Zero Nero All Season	75,000
P Zero All Season <i>Plus</i>	80,000
Scorpion™ ATR	80,000
Scorpion STR	100,000
Scorpion Verde All Season <i>Plus</i>	105,000
Scorpion Verde All Season*	(see below)

Scorpion Verde All Season Mileage Warranty

- All Scorpion Verde All Season tires produced in the year 2013 will be eligible for 80,000 kilometers limited treadwear warranty for H and V rated, and 105,000 kilometers limited treadwear for T rated.
- All Scorpion Verde All Season tires produced after the year 2013 are not eligible for mileage warranty coverage.

Road Hazard Policy For Run Flat Tires Only

Pirelli Run Flat tires are manufactured with technology that allows limited low-inflation operation in the event of sudden loss of pressure. Pirelli does not recommend the repair of run flat tires and as a result, Pirelli provides road hazard coverage on all Pirelli produced tires that are manufactured with run flat technology. To qualify for Run Flat Road Hazard coverage, a completed claim form along with the tire exhibiting the road hazard must be returned to Pirelli through an authorized Pirelli dealer.

If a Run Flat tire becomes unserviceable due to workmanship or materials anomalies or road hazard injury during the initial warranty period, which is one year from the date of original retail purchase of the vehicle or purchase of replacement tires (purchase receipt required) or within the first 2/32" of the original usable tread, whichever occurs first, the tire will be replaced with the same or comparable tire at no charge for the tire to the owner. After the initial warranty period, if a Run Flat tire becomes unserviceable due to workmanship or materials anomalies or road hazard injury, the owner must pay the cost of a comparable new Pirelli brand or PTI private brand replacement tire on a pro-rata basis. The authorized Pirelli dealer will determine the cost by multiplying the percentage of the original usable tread worn by the current dealer selling price. The owner must pay for any associated service charges, including costs associated with mounting and balancing of the tire. This Road Hazard Policy is not a warranty. PTI does not warranty that a Pirelli tire will not fail due to road hazard and does not authorize any person, including authorized Pirelli dealers, to make such a warranty.

PIRELLI TIRES

Pirelli “Seal Inside” Technology

Select Pirelli tires incorporate “Seal Inside” technology, a construction designed to stop the loss of air from a tire when punctured by an object. Providing the puncture does not compromise the structural integrity of the tire, a sealing material layer prevents possible air leakage in the event of a carcass puncture.

The “Seal Inside ” technology is not designed or intended to be a permanent repair, and is only meant to allow the consumer to go to a Pirelli dealer for an inspection to determine if repair or replacement is needed.

Visit www.ca.pirelli.com for more information.

What Is Not Covered By The Warranty?

- Tires on any vehicle registered and normally operated outside the United States of America or Canada.
- Tires transferred from the vehicle on which they were originally installed.
- Tires misapplied due to insufficient Speed Rating, Load Index, under-sized or oversized tires.
- Tires damaged from improper mounting/dismounting practices, abuse, misuse, or neglect.
- Tire dealer/retailer services: mounting, dismounting, balancing, studing, tire rotation, or wheel alignment.
- Mileage warranty on tires fitted as Original Equipment (Pirelli brand tires supplied as original equipment on new vehicles).
- Passenger tires (Euro-metric / P-metric) used on commercial vehicles or used in commercial applications.
- Tires in which any thing other than air or nitrogen has been used as the support medium.
- Tires injected with liquid balancer or sealant or any other balancing material.
- Tires which have been modified by the addition or removal of material or any tire intentionally altered to change its appearance.

- Tires improperly repaired or with repairs not conforming to Tire and Rubber Association of Canada standards, or with section repairs, or with a self-vulcanizing plug only or patch only.
- Tires which have been recapped, or retreaded, or regrooved.
- Tires used in racing or other competitive events.
- Tires removed in multiples when only one tire can be claimed, or is suspect of a claim.
- Ride related anomalies after the first 2/32" of treadwear.
- Tires which become unserviceable because of tire operation in excess of tire/wheel manufacturers' specifications and recommendations, including spinning.
- Tires which become unserviceable because of a mechanical irregularity in the vehicle such as misalignment, defective brakes, defective shock absorbers or struts, or improper rims.
- Tires damaged by fire, chemical corrosion, vandalism, wrecks, chains, theft, run while flat, under inflated, over inflated or abused during servicing.
- Tires affected by flat spotting caused by improper transport or storage.
- Tires which became unserviceable because of road hazard injuries (e.g., nails, glass, metal objects) or other penetrations or snags, bruises or impact damage, except for those Run Flat lines/sizes specifically covered by the Pirelli Road Hazard Policy.
- Tires with weather / ozone cracking which were purchased more than four years prior to presentation for adjustment. (If no proof of purchase date is available, the warranty will be four years from the DOT date).
- Summer tires that developed surface cracks due to use in low ambient temperatures. These include P Zero Silver, P Zero Trofeo, P Zero Corsa System, P Zero, P Zero Rosso™, P Zero Nero, Cinturato P1, Cinturato P7, Scorpion Zero™ and Scorpion Verde.

PIRELLI TIRES

How To Make A Claim Under This Warranty

The owner, when making a claim under the terms of this warranty, must present the tire along with proof of purchase to any authorized Pirelli Dealer. Once tires are returned to Pirelli by an authorized PTI dealer and credit has been issued, submitted tires become the property of Pirelli.

To locate an authorized Pirelli Dealer in your area, refer to the Dealer Locator at www.ca.pirelli.com.

THIS IS THE ONLY EXPRESS WARRANTY GIVEN BY PTI, APPLICABLE TO PIRELLI BRAND OR PTI PRIVATE BRAND ORIGINAL EQUIPMENT OR REPLACEMENT PASSENGER CAR RADIAL AND LIGHT TRUCK RADIAL TIRES. PTI DOES NOT MAKE ANY OTHER EXPRESS WARRANTY OR ANY IMPLIED WARRANTY OF MERCHANTABILITY OR FITNESS FOR A PARTICULAR PURPOSE. PTI DOES NOT AUTHORIZE ANY OTHER PERSON, INCLUDING AUTHORIZED PIRELLI DEALERS OR CAR MANUFACTURERS, OR CAR DEALERS, TO CHANGE THIS WARRANTY OR CREATE ANY OTHER OBLIGATION IN CONNECTION WITH PIRELLI TIRES. PTI WILL NOT DO ANYTHING OTHER THAN WHAT IS STATED IN THIS WARRANTY IF AN ANOMALY IS FOUND TO EXIST IN A PIRELLI BRAND OR PTI PRIVATE BRAND ORIGINAL EQUIPMENT OR REPLACEMENT PASSENGER CAR OR LIGHT TRUCK RADIAL TIRE. ALL OTHER REMEDIES ARE EXCLUDED, INCLUDING ANY OBLIGATION OR LIABILITY ON THE PART OF PTI FOR CONSEQUENTIAL OR INCIDENTAL DAMAGES (SUCH AS A LOSS OF USE OF VEHICLE, LOSS OF TIME OR INCONVENIENCE) ARISING OUT OF AN ANOMALY.

Some provinces do not allow the exclusion or limitation of incidental or consequential damages, so the above exclusion may not apply to you. This warranty gives you specific legal rights and you may also have other rights which vary from province to province.

If further assistance or information is needed, please contact:

Consumer Affairs Group
Monday through Friday
8:00 AM to 6:00 PM Eastern Standard Time
Eastern Canada 1-800-363-0583
Ontario 1-800-828-2585
Western Canada 1-800-663-0148

TIRE CARE AND SERVICE

1. Tire Sidewall Markings

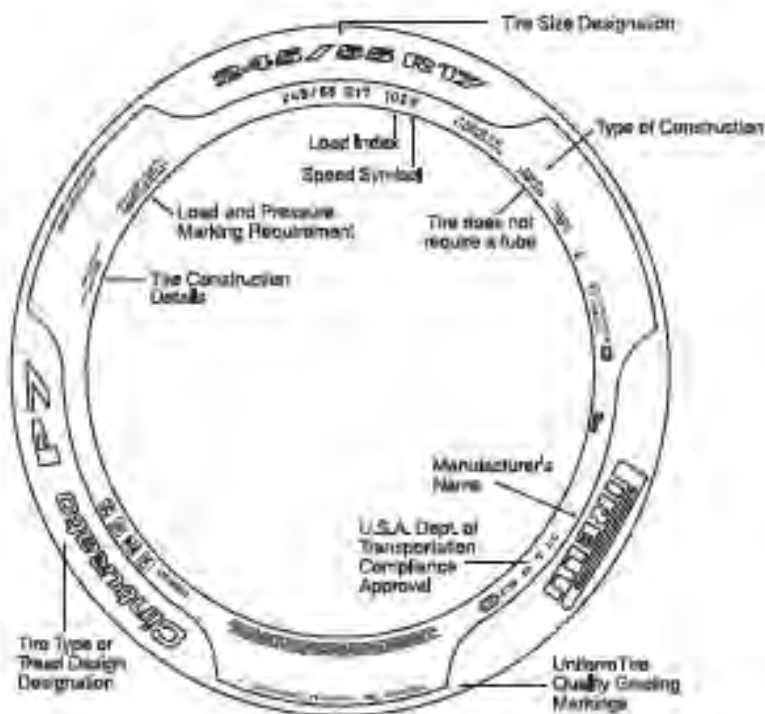

PIRELLI TIRES

Tire Size: A combination of alphabetic and numeric characters that indicate the nominal dimensions of a tire:

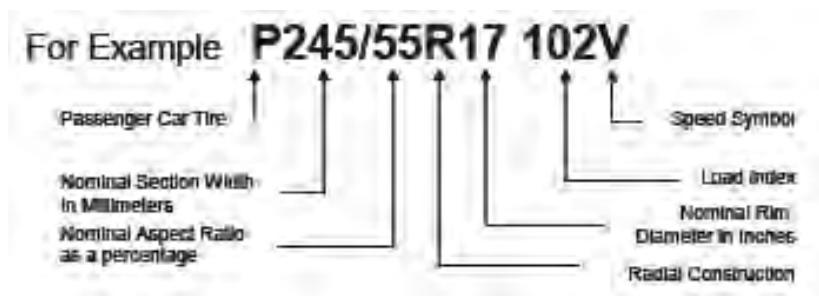

Load Index: a numerical code indicating the maximum load carrying capacity of a tire at the maximum cold inflation pressure.

LOAD INDEX	MAXIMUM LOAD PER TIRE		LOAD INDEX	MAXIMUM LOAD PER TIRE	
	Kg	Lbs		Kg	Lbs
80	450	992	106	950	2094
81	462	1018	107	975	2149
82	475	1047	108	1000	2205
83	487	1074	109	1030	2271
84	500	1102	110	1060	2337
85	515	1135	111	1090	2403
86	530	1168	112	1120	2469
87	545	1201	113	1150	2535
88	560	1234	114	1180	2601
89	580	1278	115	1215	2679
90	600	1323	116	1250	2756
91	615	1356	117	1285	2833
92	630	1389	118	1320	2910
93	650	1433	119	1360	2998
94	670	1477	120	1400	3087
95	690	1521	121	1450	3197
96	710	1565	122	1500	3307
97	730	1609	123	1550	3417
98	750	1653	124	1600	3528
99	775	1708	125	1650	3638
100	808	1764	126	1700	3748
101	825	1819	127	1750	3859
102	850	1874	128	1800	3969
103	875	1919	129	1850	4079
104	900	1984	130	1900	4190
105	925	2039	131	1950	4300

Speed Symbol: an alphabetic code indicating the maximum speed at which the tire can carry a load corresponding to its Load Index under specified service conditions.

	SPEED SYMBOL	MAXIMUM SPEED	
		KM/H	MPH
	L	120	74
	M	130	80
	N	140	86
	P	150	93
	Q	160	99
	R	170	105
	S	180	112
	T	190	118
	U	200	124
	H	210	130
	V	240	149
	W	270	168
	*ZR	Y	300
		(Y)	ABOVE 300
			ABOVE 186

*For tires having a maximum speed capability above 149 mph, a "ZR" may appear in the size designation; above 186 mph, a "ZR" must appear in the size designation, including a "Y" speed symbol in brackets.

Other Markings:

P - As part of the tire size designation (e.g., P205/65R15), is used to indicate the tires intended for service on passenger cars.

LT - As part of the tire size designation (e.g. LT235/75R15), is used to indicate the tires are intended for service on light truck vehicles.

M&S - Letters used to indicate a tire suitable for Mud and Snow and/or All Season usage.

XL - As part of the size designation (e.g. P235/75R16 XL), is used to indicate the tire can carry more load as the maximum inflation pressure and load are greater than a standard load version. (Also could be called REINFORCED).

2. Tire Categories

ALL SEASON TIRES (ALL WEATHER TIRES): Tires that are designed to perform in a variety of road conditions in all seasons of the year. An all season tire will carry "M+S", "M&S", or "M/S" designation on the sidewall. All Season tires may carry a Limited Treadwear Warranty depending on line.

SUMMER TIRES (MAXIMUM PERFORMANCE, HIGH PERFORMANCE, ULTRA HIGH PERFORMANCE): Summer Performance tires offer superior handling, grip and cornering ability compared to standard tires. They are rated for operation at higher speeds. Maximum Performance, High Performance and Ultra High Performance categories each have different performance characteristics, UTQG ratings and rate of wear depending on line. Some lines may carry a limited treadwear warranty.

WINTER TIRES (SNOW TIRES): A winter tire is a tire with a tread design and compound made specifically for snowy and icy conditions and is identified by M&S, M+S or M/S markings on the sidewalls. Tires designed for use in severe snow conditions are further identified with a pictograph of a mountain with a snowflake on the sidewalls and must meet specific snow performance test requirements. Pirelli Winter tires do not carry a mileage warranty.

The information provided above is an overview of tire types. Tread patterns and rubber compounds vary among the seasonal tire types and provide varying performance characteristics and limitations based on your individual needs and vehicle specifications. Summer performance tires are different than winter and all season types. To determine which Pirelli lines carry a Limited Treadwear Warranty, please refer to The PTI Treadwear Mileage Warranty Conditions and Mileage Warranty sections found in this document.

3. Pressure Recommendations

Recommended tire inflation pressures for your vehicle can be found either on your vehicle's tire placard or in your vehicle owner's manual. Correct pressures are related to load, speed and vehicle handling and are vital for even braking, maximum traction and good tire life. Under no circumstances should your tire's cold inflation pressure be less than that indicated on your vehicle's tire placard or in your vehicle owner's manual or higher than the maximum cold inflation pressure molded on

to the tire's sidewall. Under inflation causes excessive flexing, deterioration of the tire and rapid wear of the tread edges. Over inflation results in an uncomfortable ride, a reduced area of tire contact with the road surface (i.e., smaller tire footprint), higher susceptibility to impact damage and rapid wear on the tread center.

WARNING!

Driving on tires with improper inflation pressure is dangerous. These situations can cause a tire failure, including tread/belt separation, even at a later date, which could lead to an accident and serious personal injury or death.

Inflation pressure must be checked at least once a month and should be checked only when the tire is cold or before it has been driven. Driving even a short distance (1 kilometer or 2 to 3 minutes) causes tires to heat up and the air pressure to increase approximately 4 psi. In case it is necessary to adjust the air pressure in tires that have been driven, the air pressure should be increased to a gauge reading of 4 psi higher than the recommended cold inflation pressure.

For Example Only:

Gauge Reading of Hot Tire:	27 PSI.
Recommended Cold Inflation Pressure:	26 PSI
Desired Gauge Reading of Hot Tire:	26 PSI + 4 PSI = 30 PSI
Therefore:	Add 3 PSI

Check the cold inflation pressure on the tires, at least by the next day. Never reduce or "bleed" pressure from hot tires since your tires will then be underinflated when they cool down. Always use a reliable pressure gauge.

4. UHP Summer Tires

Rubber compounds formulated for ultra high performance summer tires can lose flexibility and may develop random surface cracks at cold temperatures. Therefore extra care should be used in handling tires in this condition. These compounds are optimized for maximum dry and wet performance in warm conditions. Special tread compounds in these tires will have decreased performance, such as lateral and braking traction, at temperatures below 7° C or when driving on snow or ice. Therefore, it is recommended to install winter tires in these conditions.

5. DOT Street Legal Competition Tires

P Zero Trofeo and P Zero Corsa tire lines use special tire construction and compounds to achieve their distinctive performance in dry conditions. As a result of that, their performance in cold temperatures, heavy rain or standing water will be decreased. Use extreme caution and drive slowly on wet roads.

The minimum tread depth will be reached earlier than normal road tires, resulting in reduced tread life.

6. Winter Tires

The standard Pirelli tires may be effective in light snow conditions. However, for winter use, you may wish to install winter tires. During winter use, Pirelli strongly recommends the fitment of 4 winter tires. Please check your vehicle owner's manual concerning winter tire size recommendation. If the winter tires have a lower speed rating than the original equipment tires, vehicle handling may be affected, and the vehicle maximum speed must be reduced to the winter tire speed rating.

Pirelli requires that studded tires be installed on all four positions. Installing studded tires only on the drive positions of any vehicle, including a front wheel drive vehicle, may cause adverse handling characteristics.

7. Run Flat Tires

Always refer to the vehicle owners' manual with respect to specific safety and operating information relating to the vehicle. Damaged Run Flat tires or Run Flat tires that have experienced a loss of pressure should immediately be replaced with another Run Flat tire of identical size and Service Description (Load Index and Speed Symbol).

Run Flat tires have been developed based on the specifications of the vehicles on which they are mounted. Accordingly, Run Flat tires should only be mounted on vehicles specifically manufactured to accommodate Run Flat tires.

Run Flat tires must be mounted in conjunction with a functional Tire Pressure Monitoring System (TPMS).

The mounting of tires and installation of the Tire Pressure Monitoring System (TPMS) should be carried out by a specialized dealer.

8. Tire Replacement

The tires fitted to your vehicle as original equipment were tested and approved by the vehicle manufacturer and the tire manufacturer and take into account all aspects of the vehicle's operation. Changes in the tire size, type or construction should not be made without seeking advice from the vehicle or tire manufacturer or an authorized Pirelli dealer since unapproved tires on your vehicle could adversely affect steering, handling, braking and traction. The tire information (tire size, load index and speed symbol) as found on the vehicle placard or in the owner's manual should always be followed when replacing tires.

It is strongly recommended that Pirelli tires be mounted in sets of four with the same tread type. Pirelli tires should not be mixed with other tire brands. It is necessary to follow this procedure because different tire constructions have different handling characteristics. Tires on the same axle must be the same manufacturer, brand, tire size, load index, speed rating and Pirelli part number.

When changing only two tires on a vehicle which is homogeneously fitted (four tires of the same tire size), fit the new tires on the rear axle. This applies to all vehicles regardless of their drive axle. (Front or Rear Drive).

On all wheel drive or four wheel drive vehicles the tires must always be replaced in sets of four.

When replacing tires on light truck vehicles, you should always follow the vehicle manufacturer's recommendations. Passenger and light truck tires are not interchangeable, due to differences in their pressures and load carrying capacity.

P-Metric and Euro-metric Interchangeability: Euro-metric (Example: 225/45R17) tires have a load index which is equal to or greater than that of the same size P-metric (Example: P225/45R17) tire. Therefore, they have the same or higher load carrying capacity at the maximum rated inflation pressure. Always check with your tire dealer or Pirelli Tire Consumer Affairs to be sure of the exact interchangeability to maintain proper vehicle dynamics.

Please be aware that it is important that, before fitting the suggested tires, the fitment is allowed by the technical specifications of the vehicle, the vehicle manufacturer and the relevant homologations. Pirelli Tire does not express any view as to the compatibility of the wheel/tire combination with the technical specifications for the chassis and vehicle.

PIRELLI TIRES

TO MAINTAIN PROPER VEHICLE DYNAMICS AND LOAD CARRYING CAPACITY, REPLACEMENT TIRES MUST ALWAYS HAVE A LOAD INDEX AND SPEED SYMBOL EQUAL TO OR GREATER THAN THOSE FITTED AS ORIGINAL EQUIPMENT.

When making plus size fitments, you should consult with the dealer regarding any suspension or braking system modifications which may be recommended for the vehicle.

9. Tire Inspection

As a minimum, tires (including the spare tire) should be examined and air pressure checked monthly and always prior to long trips. They should also be examined if you strike any unusual object on the road. Tires showing bulges, cracks, cuts, penetrations or uneven wear must be dismantled and examined by an authorized Pirelli tire dealer and replaced if necessary. Pirelli tires have treadwear indicators in the tread grooves, which show up when the tread has worn to 2/32" remaining. At this point, your tires must be replaced because they are illegal and dangerous.

The mere passage of time (age) does not cause tires to deteriorate, but rather exposure to outside forces. Such outside forces can include, but are not limited to: road hazards, punctures, improper repairs, misalignment, under inflated operation, over inflated operation, excessive heat caused by over deflected operation, excessive exposure to ozone, improper storage conditions, etc. Tire companies can only have an impact on a few of these exposures. Tire companies add antioxidants and anti-oxidants (anti-degradation compounds) to minimize degradation. Pirelli believes that since there is no way to accurately predict what outside forces a tire will be exposed to there is no scientifically supportable age limit that can be set for tires.

To avoid cosmetic damage, use a mild soap solution to clean sidewalls and rinse off with low-pressure tap water. Never apply cleaners or dressings to enhance sidewall appearance to avoid removal of antioxidants, which are intended to prevent ozone degradation. The removal of anti-oxidants may degrade the rubber and can lead to sidewall cracking. Use of high-pressure sprayers may cause sidewall damage.

WARNING!

Driving on a damaged tire is dangerous, as the tire can suddenly fail, which can lead to an accident and serious personal injury or death.

10. Tire Rotation

Pirelli recommends that you follow the tire rotation procedure as defined in your vehicle owner's manual. If there is no procedure, PTI recommends tire rotation every 8,000 to 11,000 kilometers to optimize your tire wear.

11. Tire Repair

Punctures, nail holes or cuts located in the tread area of Pirelli radial tires may be repaired if the diameter does not exceed 6 mm. The repair material used must seal the innerliner and fill the injury to be considered a permanent repair. Tire and Rubber Association of Canada and industry approved repair methods include a combination of plug and patch; chemical or hot vulcanizing patches, and head type plugs, all applied from inside the tire. A self-vulcanizing plug repair may be used only in conjunction with a patch repair, but not by itself. Plugs may cause further damage to the tire, they are not always airtight and the plug may fail. If a tire puncture exceeds 6 mm or is located in the shoulder or sidewall deflection areas, the tire must be replaced. Never resort to tubes (in tubeless tires) or sleeves or large thick patches, which can upset the balance and may result in a sudden failure at highway speeds and high operating temperatures.

WARNING!

Driving on an improperly repaired tire is dangerous, as the tire can suddenly fail, which can lead to an accident and serious personal injury or death.

PIRELLI TIRE DOES NOT ENDORSE:

- The use of tire sealants in Pirelli tires to repair, even temporarily, a puncture;
- The repairing of V, W, Y or Z Speed Rated tires;
- The repairing of Run Flat tires.

12. Storage

Should you need to store tires after removal from a vehicle (as in the case of winter tires), they should be stored in a cool, dry place. To protect your tires from damage related to: heat, water, ozone and direct sunlight, it is suggested you place them in opaque, waterproof containers (e.g., plastic trash bags).

13. Tubes in Tubeless Tires

Under no circumstances are tubes to be used in Pirelli tires marked "Tubeless". This includes tires that have been repaired. If the tire's pressure retention ability has been affected, so as to necessitate a tube being installed, the tire must be replaced.

14. Tire Valves

Whenever new tires are installed on your wheels, new tire valves of the correct type must be installed. During your routine tire inspection, verify that all your valves have proper valve caps. Replace as necessary, since the valve cap is also a seal against pressure loss.

15. Tire Demounting and Mounting

Tire fitting is best left to professionals who have the proper tools and equipment to perform the task properly and safely. Your tires should be mounted or demounted, using Tire and Rubber Association of Canada procedures or the vehicle manufacturers' recommendations. Your wheels should be in good, clean condition. Wheels should be inspected for distortion, dents, cracks, rust and foreign matter, and be replaced as necessary. NEVER EXCEED 40 PSI WHEN SEATING BEADS.

16. Tire/Wheel Alignment and Balancing

Tire/Wheel alignment specifications are issued by your vehicle manufacturer and your vehicle must be kept within these tolerances. You should have your alignment checked annually or whenever you notice any irregular wear or vibrations. Tire/ Wheel assemblies should be balanced each time a tire is fitted to a wheel. Tire/Wheel alignment and balancing are important for safety and maximum performance and mileage from your tires.

For more information or service regarding Pirelli tires, please contact your nearest Authorized Pirelli Dealer. To locate an authorized Pirelli

Dealer in your area, refer to the Dealer Locator section on the Pirelli web site at www.ca.pirelli.com.

P ZERO, P ZERO CORSA, P ZERO ROSSO, P ZERO NERO, CINTURATO, SCORPION, SCORPION ZERO, SCORPION VERDE, P3000, P1, P4, P5, P6, P7 are trademarks of Pirelli Tyre S.p.A.

“Confidence *Plus* Program” is a trademark of Pirelli Tire Inc.

1111 Dr. Frederik-Philips Blvd, Suite 506
St-Laurent (Quebec) H4M 2X6
Eastern Canada 1-800-363-0583
Ontario 1-800-828-2585
Western Canada 1-800-663-0148
www.ca.pirelli.com

NOTES

TOYO TIRES – LIMITED WARRANTY

LIMITED WARRANTY FOR ORIGINAL EQUIPMENT TOYO TIRES

WHAT IS COVERED AND FOR HOW LONG?

This Limited Warranty covers all Toyo brand passenger car, light truck and temporary spare tires installed as original equipment on vehicles that are sold and used within the United States.

Eligible Tires

Your tires are covered under this Limited Warranty if all of the following criteria are met:

- The tire was installed on your vehicle at the factory as an original equipment part.
- You are the original purchaser of the vehicle.
- You purchased the vehicle after November 2011*.
- You have always used the tires with this vehicle.
- The tires have been used for normal street driving.
- The vehicle has not been used for commercial service.
- You properly maintained and used the tire (See “Tire Safety and Maintenance Information” section below).
- The tires are not subject to an exclusion (See “What is Not Covered?” section below).
- You fulfill the warranty claim procedure (See “How to Make a Claim” section below).

Eligible Tires are covered under this Limited Warranty for a period of up to 5 years from the date you purchased your new vehicle. Toyo Tires will replace it with a comparable new Toyo brand tire in the manner explained in the “What Toyo Tires Will Do” section below.

WHAT IS NOT COVERED?

This Limited Warranty does not cover the following categories of claims:

Rapid Treadwear: Original equipment tires are not guaranteed to last a specified number of miles. Damage from road hazards (not limited to cuts, snags, bruises, impact breaks, bulges, punctures, stone drills, chips, and scales), fire, theft, or collision.

Conditions arising from improper tire/vehicle maintenance or use, not limited to:

- Irregular or excessive treadwear due to: Incorrect inflation; overloading; vehicle misalignment; failure to rotate tires; and poor or defective mechanical condition of brakes, shocks, and wheels; or other factors attributable to the vehicle or wheel.
- Any tire which has been run with low air pressure or while flat.
- Damage due to abuse; vandalism; tire alteration; tire spinning; racing; or other competitive activities.
- Damage, corrosion, or deterioration from using oil-based chemicals, water-based sealers, balancing substances, or flammable gases.
- Damage from improper use of tire chains.

Tires with the DOT identification number removed or rendered illegible.

* Vehicles purchased before November 2011 may be covered by an earlier warranty. See your Toyo Tires retailer or contact Toyo Tires for more information.

Improper mounting, balancing or repair, not limited to:

- Improper tire mounting, or tire/wheel assembly imbalance.
- Damage from incorrect mounting or dismounting of the tire, incorrect wheel size, water or other material trapped inside the tire during mounting, or failure to keep the tires balanced.
- Damage resulting from improper repair materials or procedures.

Failure to meet conditions of this Limited Warranty, not limited to:

- Any tire that is not an Eligible Tire.
- Any tire for which mileage and tire rotation records are not available or verifiable.
- Any tire not presented and available for Toyo Tires' inspection.
- Any tire worn beyond the treadwear indicators (less than 2/32" of remaining tread).
- Uniformity issues after the first 25% of treadwear.

Temporary spare tires that are used at speeds over 50 miles per hour.

Nothing in this Limited Warranty is intended to be a representation that tire failures cannot occur.

WHAT TOYO TIRES WILL DO

For every Eligible Tire, Toyo Tires will do the following:

Regular OE Tires

1. If less than 25% Worn: Toyo Tires will replace, free of charge, any Eligible Tire when the original usable tread is worn by 25% or less, and within 5 years from the date you purchased the vehicle new. If you cannot provide a copy of the new vehicle registration or vehicle purchase receipt, the manufacture date of the tire, as indicated by the tire DOT code, will be used instead to determine if a tire is within the warranty period. Tire mounting and balancing costs are covered by Toyo Tires. **You are responsible for taxes and all other costs, fees and expenses.**
2. If more than 25% Worn: Toyo Tires will replace any Eligible Tire when the original usable tread is worn by more than 25%, and within 5 years from the date you purchased the vehicle new. If you cannot provide a copy of the new vehicle registration or vehicle purchase receipt, the manufacture date of the tire, as indicated by the tire DOT code, will be used instead to determine if a tire is within the warranty period. **You are responsible for the pro-rated cost of a replacement tire, mounting and balancing costs, taxes and all other costs, fees and expenses.**

TOYO TIRES – LIMITED WARRANTY

Temporary Spare Tire

1. If less than 50% Worn: Toyo Tires will replace, free of charge, any Eligible Tire when the original usable tread is worn by 50% or less, and within 5 years from the date you purchased the vehicle new. If you cannot provide a copy of the new vehicle registration or vehicle purchase receipt, the manufacture date of the tire, as indicated by the tire DOT code, will be used instead to determine if the tire is within the warranty period. Tire mounting and balancing costs are covered by Toyo Tires. **You are responsible for taxes and all other costs, fees and expenses.**
2. If more than 50% Worn: Toyo Tires will replace any Eligible Tire when the original usable tread is worn by more than 50%, and within 5 years from the date you purchased the vehicle new. If you cannot provide a copy of the new vehicle registration or vehicle purchase receipt, the manufacture date of the tire, as indicated by the tire DOT code, will be used instead to determine if the tire is within the warranty period. **You are responsible for the pro-rated cost of a replacement tire, mounting and balancing costs, taxes and all other costs, fees and expenses.**

The **original usable tread** is determined by measuring the depth on the tread of an identical model of a new Toyo brand tire to the top of the treadwear indicator bars (note: the original usable tread depth will vary by tire model).

The **prorated cost of a replacement tire** is determined as follows: $[(\text{Original usable tread worn}) \div (\text{Original usable tread})] \times (\text{Actual current dealer selling price})$.

A **comparable Toyo brand tire** is the same tire, or a tire of the same basic construction and quality, as the original tire, as determined by Toyo Tires.

HOW TO MAKE A CLAIM

To make a claim under this Limited Warranty, you must:

1. Present your vehicle with the subject tire(s), to an authorized Toyo Tires dealer.
2. Complete and sign the Toyo Tires Limited Warranty Claim form provided by the dealer.
3. Keep a copy of the Claim form for your records, and leave the subject tire with the dealer.

Your claim will be administered in accordance with the limited warranty that was in effect when you purchased the vehicle new.

YOUR LEGAL RIGHTS

This Limited Warranty gives you specific legal rights, and you may also have other rights which vary from state to state.

LIMITATIONS AND EXCLUSIONS

TOYO TIRES DISCLAIMS ALL OTHER WARRANTIES, EXPRESS OR IMPLIED, INCLUDING THE IMPLIED WARRANTY OF MERCHANTABILITY, THE IMPLIED WARRANTY OF FITNESS FOR A PARTICULAR PURPOSE, AND LIABILITY FOR INCIDENTAL AND CONSEQUENTIAL DAMAGES (e.g., loss of time, loss of use of vehicle, towing charges, road services, cost of rental car, inconveniences, etc.).

Some states do not allow the exclusion or limitation of incidental or consequential damages, so the above exclusions may not apply to you.

The terms of this Limited Warranty may not be changed by anyone, including any Toyo Tires employee, representative, or dealer.

Toyo Tires does not warrant any work performed by the dealer, including, but not limited to, their selection, fitment, mounting and balancing, inspection or repair of any tire.

CONTACT INFORMATION

If you need assistance, please contact your authorized Toyo Tires retailer. To locate an authorized Toyo Tires dealer, use our dealer locator at www.toyotires.com, or contact Toyo Tires Consumer Relations at:

TOYO TIRE U.S.A. CORP.
P.O. Box 6052
Cypress, California 90630-5249
1-800-442-8696
(6:30am to 5:00pm Pacific Time)

TIRE SAFETY AND MAINTENANCE INFORMATION

IMPORTANT SAFETY INFORMATION

This manual is not intended to provide proper training or service procedures for tire mounting, dismounting, balancing, rotation, or repair. Please leave these tasks to qualified tire service professionals.

TOYO TIRES – LIMITED WARRANTY

NOTE:

- Toyo brand tires are designed and built with great care. Any tire, no matter how well constructed, can fail as a result of punctures, impact damage, underinflation/overloading or other conditions resulting from use. Tire failures may create a risk of property damage or personal injury. To obtain the highest possible performance, tires must be maintained properly.
- Remember, you are ultimately responsible for the tires installed on your vehicle.

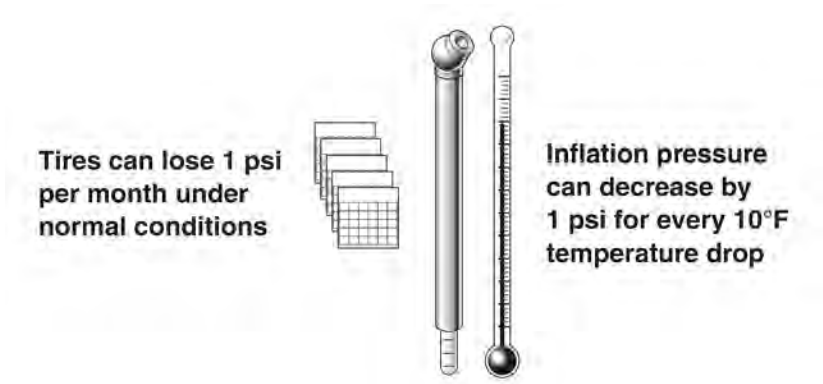

Inflation pressure can decrease by 1 psi for every 10°F temperature drop
Important factors in tire care are:

- Proper inflation pressure
- Proper vehicle loading
- Proper vehicle maintenance
- Regular inspection
- Good driving habits

Refer to your vehicle Owner's Manual for additional tire safety and service advice.

TIRE PRESSURE BASICS

The combined effect of losing 1 psi per month over several months along with a 1 psi decrease for every 10°F temperature drop could add up to a severe “run low” condition; consequently, it is important to check your tires’ inflation pressure at least once per month. Inflation pressure enables a tire to support its load; therefore, proper inflation is critical.

HOW TO DETERMINE PROPER TIRE INFLATION PRESSURE

It is impossible to determine whether tires are properly inflated just by looking at them.



25 PSI



35 PSI

It is important to check your tires using an accurate tire pressure gauge, which can be purchased at your tire dealer or auto supply store.

Under inflation can overload tires. Check the inflation pressure every month, including for the spare tire, to make sure it's up to specification. Check it again before long trips or when carrying extra weight.

Look for the manufacturer's recommended inflation pressure listed on the Tire Information Placard usually located on your vehicle's door edge, door post, glove box, or inside the trunk lid.

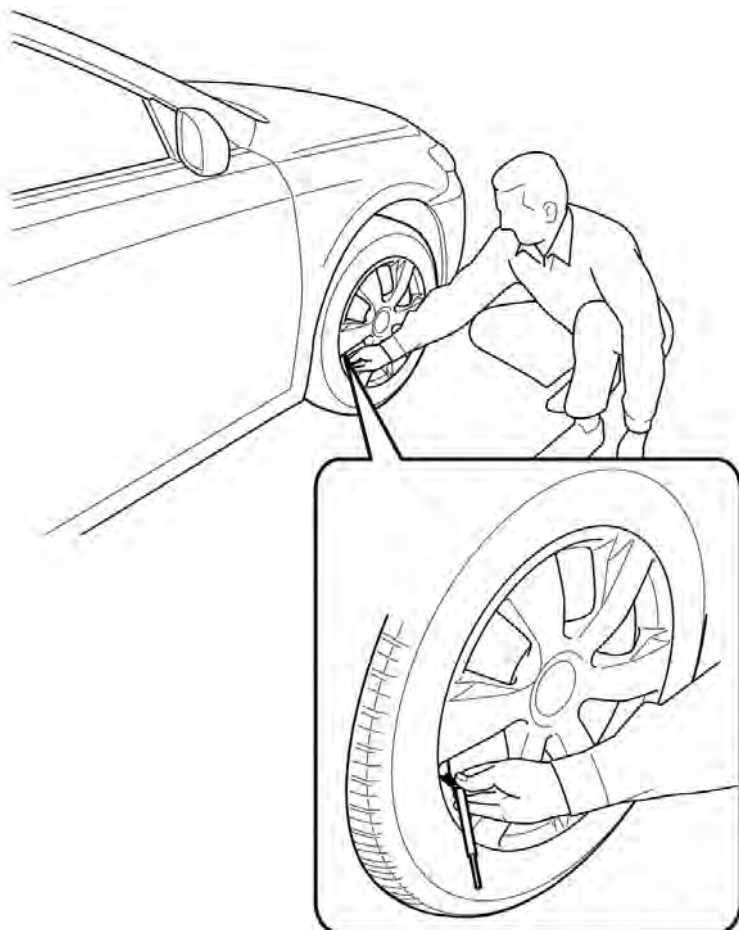

NOTICE

The inflation pressure shown on the sidewall of the tire is not the intended inflation pressure for the vehicle! Always refer to the vehicle's Tire Information Placard.

TOYO TIRES – LIMITED WARRANTY

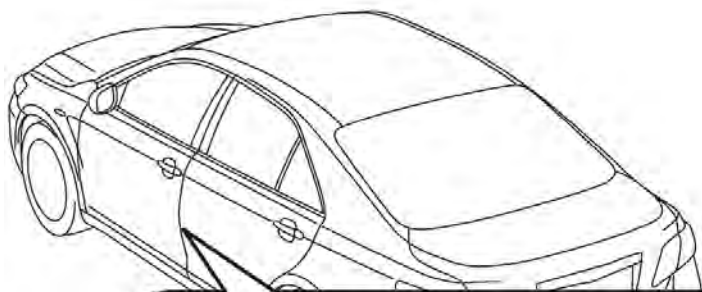

TIRE AND LOADING INFORMATION			INFORMATION SUR LES PNEUS ET LE CHARGEMENT			
SEE OWNER'S MANUAL FOR ADDITIONAL INFORMATION	SEATING CAPACITY TOTAL 5 FRONT 2 - REAR 3 The combined weight of occupants and cargo should never exceed 385 kg or 850 lbs.		NOMBRE DE PLACES ASSISES TOTAL 5 AVANT 2 - ARRIERE 3 Le poids total des occupants et du chargement ne doit jamais être supérieur à 385 kg ou 850 lb.			
	TIRE	SIZE	COLD TIRE PRESSURE	PNEUS	DIMENSION	PRESSION DE GONFLAGE À FROID
	FRONT	225/45R17	240kPa, 35PSI	AVANT	225/45R17	240kPa, 35PSI
	REAR	225/45R17	220kPa, 32PSI	ARRIÈRE	225/45R17	220kPa, 32PSI
SPARE	T135/70D17	420kPa, 60PSI	SECOURS	T135/70D17	420kPa, 60PSI	

C3
N10000-01010-000101

POUR DE PLUS
AMPLES INFOR-
MATIONS VOIR
LE MANUEL
DU PROPRIÉTAIRE

WARNING!

Driving on tires with insufficient inflation pressure is dangerous because it will cause your tires to overheat. This can cause sudden tire failure, which may result in loss of vehicle control and lead to serious personal injury or death.

USING A TIRE PRESSURE GAUGE

For accuracy, check your inflation pressure with a tire pressure gauge when tires are cold (for example, after being parked overnight). Driving heats up tires and causes an inaccurate pressure reading.

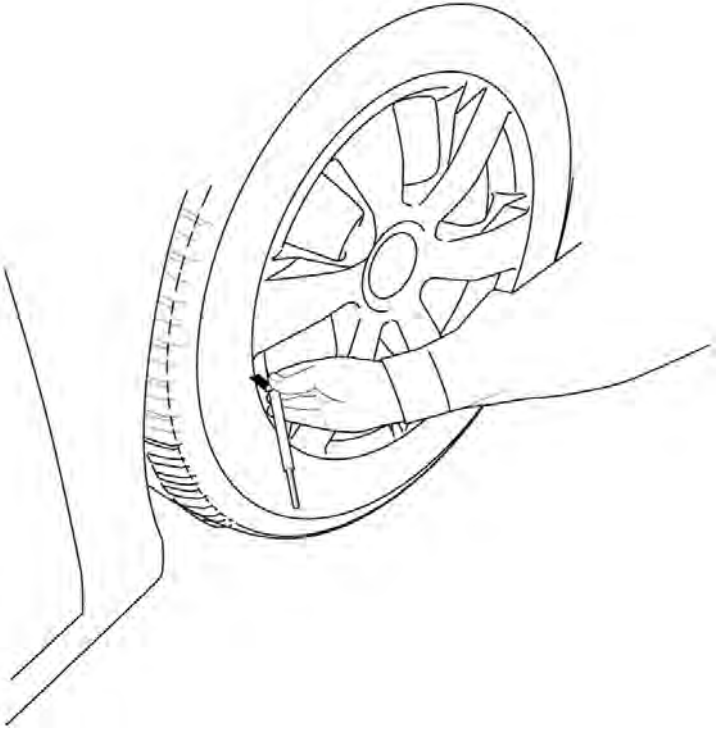

To check inflation pressure with a tire pressure gauge:

1. Remove the tire valve cap.
2. Place the end of the tire pressure gauge over the valve.
3. Press the tire pressure gauge straight and firmly and take a reading.
4. If needed, inflate and recheck the pressure with the tire pressure gauge.
5. Replace the valve cap.

RECOMMENDATIONS FOR SAFE TIRE INFLATION

- If you must inflate your tires when they are hot, add 4 pounds per square inch (4 psi) (28 kPa) above the recommended inflation pressure specification. Recheck the inflation pressure when the tires are cold and adjust to the recommended inflation pressure shown on the vehicle's Tire Information Placard.

TOYO TIRES – LIMITED WARRANTY

- Never release air or nitrogen from a hot tire in order to reach the recommended cold tire pressure. Normal driving causes tires to run hotter and inflation pressure to increase. If you release pressure when your tires are hot, you may dangerously underinflate your tires. If your tires lose more than 1 pound per square inch (1 psi) per month, the tire, the valve, or the wheel may be damaged. Consult your authorized Toyo Tires dealer for an inspection.
- Over-inflation can cause the tire to be more susceptible to impact damage.
- Over-inflation or underinflation may adversely affect vehicle handling.
- Remember to check your spare tire. Consult your vehicle Owner's Manual for the correct inflation pressure and use of a "temporary use" spare tire. The inflation pressure specified for a spare tire is typically different from that specified for your regular tires.
- Use valve caps to keep valve cores clean and clear of debris and to help guard against air leakage.

WARNING!

Never inflate a tire unless it is secured to the vehicle or a tire mounting machine. Inflating an unsecured tire is dangerous. If the tire bursts, it could be propelled into the air with explosive force and cause serious personal injury or death.

VEHICLES EQUIPPED WITH TIRE PRESSURE MONITORING SYSTEMS (TPMS)



Even if your vehicle is equipped with a tire pressure monitoring system, you should check your tire pressure at least once per month when the tires are cold (for example, after being parked overnight). Tire pressure warning systems are not a substitute for regular tire pressure maintenance.

WARNING!

If your vehicle is equipped with TPMS, read the vehicle Owner's Manual regarding its operation. Some TPMS systems do not alert you until the tires are significantly underinflated, which could result in permanent tire damage and possible sudden tire failure. In the event that your TPMS malfunction indicator lamp is displayed, you should immediately pull over to a safe parking area and check your tires.

IDENTIFYING DAMAGED WHEELS

Periodically check to see if any of the following symptoms exist, in which case the wheel must be replaced:

- If the flange is bent.
- If welds or rivets are leaking.
- If the stud holes are elongated and not round. (Improper lug nut tightening could cause this.)
- If there are cracks in the wheel.

WORN OUT TIRES

Tires must be replaced when tread is worn to 2/32" (1.6 mm). Treadwear indicators on Toyo tire treads show the 2/32" depth (1.6 mm). Most states require that tires be replaced when the tread depth is worn to 2/32" (1.6 mm). Tires may lose sufficient wet and snow traction before reaching 2/32" (1.6 mm) of wear. Many wet weather accidents result from skidding on worn out tires.

Excessively worn tires are more susceptible to penetrations. Consider replacing your tires earlier if you drive in snow or wet conditions.

WARNING!

Continued operation of your vehicle with excessively worn tires may lead to loss of vehicle control in adverse weather conditions, tire failure, and serious personal injury or death.

Any retail tire dealer will be glad to measure your tire's tread depth for you. Toyo Tires recommends that tires be replaced in matched sets of four.

TIRE REPAIRS

If any tire has sustained a puncture, have the tire dismounted and inspected internally by an authorized Toyo Tires dealer for possible damage that may have occurred. Only specially trained personnel using the proper tools and procedures should repair tires.

WARNING!

- **Before having your tire repaired, tell your authorized Toyo Tires dealer if you have used an aerosol puncture sealant to inflate/ seal the tire. Aerosol puncture sealants could contain a highly flammable, explosive gas.**
 - **Driving on an improperly repaired tire is dangerous. An improper repair can cause further damage to the tire. It could fail suddenly, which can result in loss of vehicle control and lead to serious personal injury or death. To insure safety, go to your authorized Toyo Tires dealer for professional inspection and proper tire repairs.**
 - **Cosmetic Tire Alterations Can Be Dangerous! Remember — Do not perform or allow anyone to perform any alterations to your tires. Alterations may prevent proper performance, leading to tire damage, which could result in sudden tire failure and loss of vehicle control and lead to serious personal injury or death.**
- Never repair a tire with 2/32" (1.6 mm) or less tread remaining. At this tread depth, the tire is worn out and must be replaced.
 - Never repair a tire with a puncture larger than 1/4" (6.4 mm) in diameter. Such tires cannot be properly repaired and must be replaced.
 - Repairs of all tires (radial and non-radial) must be of the plug and inside patch type. Using plugs alone on any type of tire is not a safe repair.
 - Do not use a rope type plug for repair. A tire must be removed from the wheel and inspected for interior damage. Any tire repair done without removing the tire from the wheel is improper and unsafe.
 - Never repair a tire with a puncture or other damage outside the tread area. Do not repair sidewall damage. Such tires cannot be properly repaired and must be replaced.

Puncture Repair Area

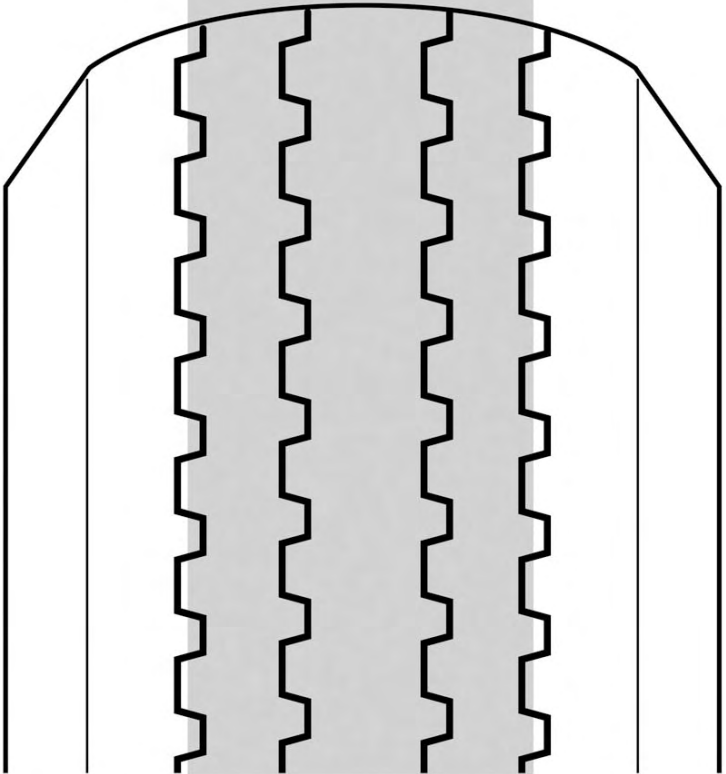

Toyo Tires speed-rated passenger car tires may be repaired and returned to service under the following conditions:

- Proper repair materials and procedures have been used.
- The damage or puncture is not larger than 1/4" (6.4 mm) in diameter.

TOYO TIRES – LIMITED WARRANTY

- The repair will be the first repair performed on that tire. (Only one repair per tire is permitted in order to maintain a limited speed rating.)
- The tire must have more than 2/32" (1.6 mm) of tread remaining.

Toyo Tires speed-rated passenger tires that have been properly repaired qualify for reduced speed ratings as follows:

ORIGINAL SPEED RATING	AFTER PUNCTURE REPAIR
(Y), Y, W, Z, V, VR, H	H (maximum speed 130 mph)
T	T
S	S

The maximum speed of a vehicle is limited by the lowest-speed- rated tire on the car.

NOTE: A tire's speed rating is void if the tire has been retreaded, damaged, abused, or otherwise altered from its original condition. Thereafter, it should be treated as a non-speed-rated tire. In addition, retreaded passenger and light truck tires are not warranted by Toyo Tires for any reason. Toyo Tires speed ratings are voided for retreaded tires.

PROPER SELECTION OF TIRES

When tires need to be replaced, don't guess what tire is right for your vehicle. First look at the vehicle Owner's Manual or the Tire Information Placard. They tell you the size of the tires that were on the vehicle as original equipment.

Replacement tires for any vehicle must be of a size, load range, and load capacity (by inflation) that is capable of supporting the same load as the vehicle's originally installed (OE) tires. Avoid installing used tires on a vehicle. There is no way to determine what road hazards or abuse a previously owned tire may have incurred.

WARNING!

- **Failure to install tires with adequate load capacity will result in tire fatigue and sudden tire failure. This could lead to loss of vehicle control, possibly resulting in personal injury or death.**

(Continued)

WARNING! (Continued)

- **Certain vehicle performance parameters, including ride comfort and handling, may be affected by substitute tire sizes. In some cases, particularly for SUVs and light trucks, a failure to follow the vehicle manufacturer's recommendations for tire replacement could adversely affect the safe handling of the vehicle, possibly resulting in a loss of vehicle control leading to personal injury or death.**

The following procedures concerning replacement tires must be followed:

- Confirm that the load-carrying capacity is greater than or equal to the load-carrying capacity of the OE tire size at the pressure indicated on the vehicle Tire Information Placard.
- Carefully note any differences between recommendations for front and rear axle positions regarding the tire size and/ or inflation pressure.
- The speed rating must be equal to or greater than what is specified by the vehicle manufacturer if the speed capability of the vehicle is to be maintained.
- Tires should be mounted on approved wheel widths. If changing tire sizes, check to make sure the wheel has adequate load and inflation pressure capacity.
- Body and chassis clearance must be checked on the vehicle's front and rear axles.

In addition to the above, light truck tire replacements should take into consideration the following:

- Proper spacing between dual tires is necessary for optimum tire performance. If chains are used, particular care must be taken to assure adequate clearance between loaded tires to avoid damage from the chains. The allowable outside diameter difference between a tire and its dual mate is 1/4" (6.4 mm) for light truck tires.

CONSIDERATIONS IN PLUS SIZING

Always refer to and follow the vehicle manufacturer's replacement tire recommendations. In some cases, a vehicle manufacturer may specifically advise against the application of replacement tires that are not of the original size or type.

TIRE AND WHEEL MATCHING AND MOUNTING

WARNING!

Any attempt to mount a tire on a wheel with a different diameter will result in an explosion of the tire/wheel assembly that could cause severe personal injury or death. Prior to mounting any tire, always check the wheel identification stamp to verify the correct wheel diameter. Always check the tire size molded onto the sidewall. Never exceed 40 psi when seating the tire beads onto the wheel. Always stand well clear of any tire mounting operation. This is especially important when the service operator inflates the tire. If the tire has been improperly mounted, it could burst with explosive force causing serious personal injury or death.

A new valve stem must be installed on the wheel each time a worn out passenger or light truck tire is replaced.

Removing and replacing tires on wheels can be dangerous.

Attempting to mount tires with improper tools or procedures could result in a tire explosion, causing serious personal injury or death.

This is a job for your authorized Toyo Tires dealer or other qualified tire service location only.

Serious personal injury or death can result from:

- Failure to select the proper tire and wheel. The tire must match the width and diameter requirements of the wheel. When mounting truck type radial tires use only wheels approved for radial tires.
- Failure to inspect both the tire and wheel. The wheel must be free of cracks, dents, chips, and rust. The tire must be free of bead damage, cuts, and punctures.
- Failure to follow proper procedures. For proper mounting procedures, consult the Rubber Manufacturers Association's publication "Care and Service of Automobile and Light Truck Tires" (ref.: www.rma.org). beads are fully seated before adjusting the inflation pressure to the level recommended for vehicle operation.

Never put flammable substances in the tire/wheel assemblies at any time. Never put any flammable substance into a tire/wheel assembly and attempt to ignite it in order to seat the beads.

TIRE MIXING**CAUTION!**

Driving your vehicle with an improper mix of tire sizes, constructions, and speed ratings can be dangerous. Your car's handling characteristics can be adversely affected. You could have an accident resulting in serious personal injury or death. Consult your vehicle Owner's Manual or an authorized Toyo Tires dealer for proper tire replacement.

- Toyo Tires recommends that all four tires be of the same size, speed rating, and construction (radial or non-radial). In some cases the vehicle manufacturer may require different sized tires for the front or rear axles. Never mix P-metric or European Metric passenger tires with LT-metric tires on the same vehicle.
- Match tire size designations in pairs on an axle, except during the temporary use of a spare tire.
- If two radial tires and two non-radial tires are used on a vehicle, put the radials on the rear axle. If radial and non-radial tires are used on a vehicle equipped with dual rear tires, the radial tires may be used on either axle.

SPEED-RATED TIRE

- If the vehicle Tire Information Placard and/or the vehicle Owner's Manual specifies speed-rated tires, the replacement tires must have the same or higher speed rating to maintain vehicle speed capability.
- If a replacement tire has a lower speed capability than that specified by the vehicle manufacturer, the vehicle's speed must be restricted to that of the replacement tire. Vehicle handling could also be affected. Consult the vehicle Owner's Manual or tire manufacturer for recommendations.
- If tires with different speed ratings are used, it is recommended that the lowerspeed- rated tires always be placed on the front axle. This is to prevent a potential oversteer condition.

TIRE SAFETY AND MAINTENANCE INFORMATION

IMPORTANT SAFETY INFORMATION

This manual is not intended to provide proper training or service procedures for tire mounting, dismounting, balancing, rotation, or repair. Please leave these tasks to qualified tire service professionals.

NOTE:

- Toyo brand tires are designed and built with great care. Any tire, no matter how well constructed, can fail as a result of punctures, impact damage, underinflation/overloading or other conditions resulting from use. Tire failures may create a risk of property damage or personal injury. To obtain the highest possible performance, tires must be maintained properly.
- Remember, you are ultimately responsible for the tires installed on your vehicle.

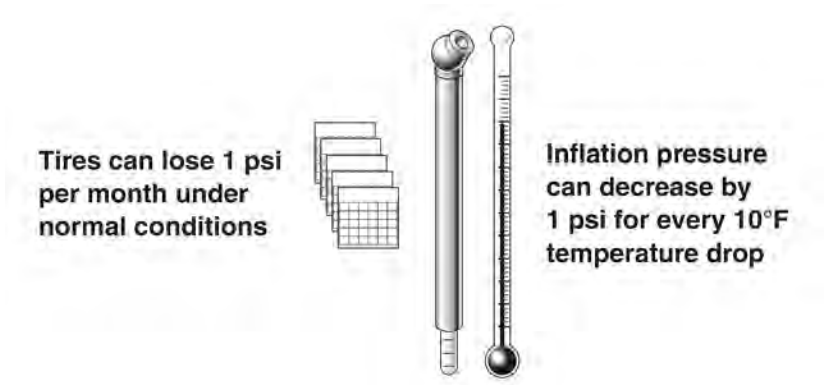

Inflation pressure can decrease by 1 psi for every 10°F temperature drop
Important factors in tire care are:

- Proper inflation pressure
- Proper vehicle loading
- Proper vehicle maintenance
- Regular inspection
- Good driving habits

Refer to your vehicle Owner's Manual for additional tire safety and service advice.

STUDLESS WINTER/SNOW TIRES

- It is always preferable to apply winter/snow tires to all wheel positions, including dual tires, to maintain vehicle mobility and control.
- If winter/snow tires are applied to the front axle of any vehicle, winter/snow tires must also be installed on the rear axle. **DO NOT** apply winter/snow tires only to the front axle. This applies to all passenger and light truck vehicles, including front-wheel-drive, 4WD, and AWD vehicles.
- If winter/snow tires are installed on the rear axle of any vehicle, it is recommended (but not required) that they also be installed on the front axle.

WARNING!

Unless winter/snow tires on the rear axle have comparable traction qualities to the tires on the front axle, the vehicle may experience adverse handling characteristics. This may result in loss of vehicle control, which can lead to serious personal injury or death.

STUDED WINTER/SNOW TIRES

- Studded winter/snow tires have higher traction qualities under most winter weather conditions.
- If studded winter/snow tires are installed on the **front axle of any vehicle, studded winter/snow tires must also be installed on the rear axle. DO NOT** apply studded winter/snow tires only to the front axle.
- If studded winter/snow tires are installed on the rear axle of any vehicle, **it is strongly recommended that they should also be installed on the front axle. Only if studded winter/snow tires are installed on all wheel positions of a vehicle will optimum handling characteristics be achieved.**

WARNING!

Installing only two studded winter/snow tires on the front axle of any vehicle (including front-wheel-drive vehicles) without studded winter/snow tires on the rear axle can cause adverse vehicle handling characteristics. This can result in a loss of vehicle control, which could cause serious personal injury or death.

NOTE: In some cases, the vehicle manufacturer may specifically advise against replacing fewer than all four tires. Always check and follow the recommendations in the vehicle Owner's Manual. For 4WD and AWD vehicles, even small differences in outside diameter may cause drivetrain damage or mechanical malfunction.

REPLACING TWO TIRES

- When a pair of replacement tires is selected in the same size and construction as those on the vehicle, the two newer tires must be installed on the rear axle and must be of equal or higher speed rating than the front tires. Generally, new tires with deeper tread will provide better grip and evacuate water more effectively, which is important as a driver approaches hydroplaning situations. Placing greater traction on the rear axle on wet surfaces is necessary to prevent a possible oversteer condition and loss of vehicle stability.
- When two new tires have been installed onto the rear axle positions, they are to be kept on the rear but rotated from side to side. This is recommended after installing two new tires to the rear position, or if you discover significant tread depth differences between the front and rear positions during rotation intervals.

REPLACING ONE TIRE

- Replacing a single tire on a vehicle can have an adverse effect on suspension systems, gear ratios, transmission, and tire treadwear.
- If single tire replacement is unavoidable, it is recommended that the single new tire be paired with the tire that has the deepest tread and both be placed on the rear axle. Placing greater traction on the rear axle on wet surfaces is necessary to prevent a possible oversteer condition and loss of vehicle stability.

WHEEL ALIGNMENT AND BALANCING

- Proper wheel alignment and balance are very important considerations for safety and getting the maximum mileage from your tires. You need to check how your tires are wearing at least once a month.
- Your vehicle may be out of alignment if your tires are wearing unevenly, such as when the inside shoulder of the tire is wearing faster than the rest of the tread. This condition not only shortens the life of your tires, it adversely affects the handling characteristics of your vehicle, which could be dangerous. If your tires show irregular wear, have your vehicle's alignment checked immediately.

TIRE WEAR – VISUAL CHECK

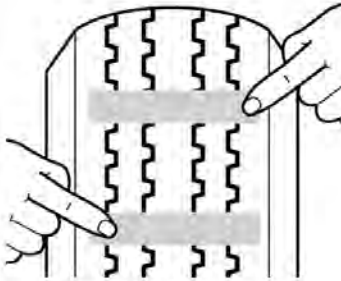

Exposed tread bars
(replace)

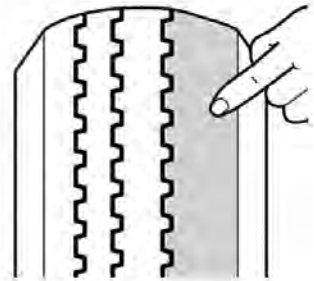

Irregular shoulder wear
(have inspected)

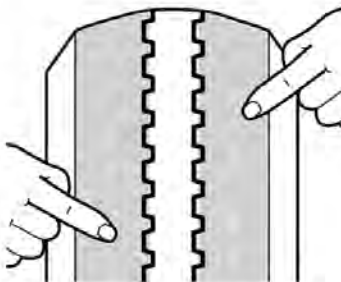

Shoulder wear
(have inspected)

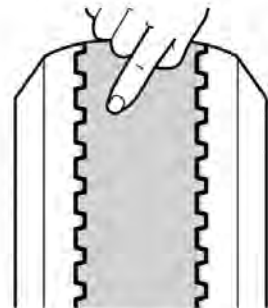

Center wear
(have inspected)

WARNING!

Beware of Sudden Tire Vibration. A tire failure may lead to loss of vehicle control, which could cause serious personal injury or death. Many tire failures are preceded by vibration, bumps, bulges, or irregular wear. If while driving your vehicle you experience any unusual vibration, pull, ride disturbance, or noise and/or you suspect possible vehicle or tire damage, do not continue to drive. Pull over to a safe area as soon as possible and inspect the tires for signs of bulges, blisters, or separations. Seek roadside assistance or change the damaged tire with your spare tire.

If you experience a blowout or a sudden tire failure, the following information should be helpful:

- When the tire failure occurs, you may hear a loud noise, or feel a vibration, and/or the vehicle may pull toward the side of the failed tire. Do not abruptly brake or turn.
- Maintain steady pressure on the accelerator pedal.
- Hold the steering wheel firmly and steer to maintain your lane position.
- Find a safe place to pull off the road and allow the vehicle to gradually decelerate. Apply light braking as required to stop safely.
- Gradually pull over to the shoulder and come to a stop. Look for a damaged tire on your vehicle.
- Seek roadside assistance or change the damaged tire with your spare tire.
- Have all of your tires and the vehicle thoroughly inspected by a tire professional.

TIRE ROTATION

The purpose for rotating tires is to achieve more uniform wear for all tires on a vehicle. Your tires should be thoroughly examined on a lift by a tire dealer for any abnormalities. If tires show uneven treadwear, ask the service person to check and/or correct any vehicle wheel alignment or other mechanical problem before rotation.

The following rotation patterns are acceptable. Please refer to your vehicle Owner's Manual for rotation advice.

Full-size spare tires (not temporary spares) of the same size, construction, and speed rating may be used in a five-tire rotation pattern.

After rotation, check the inflation pressure of all the tires. The front and rear tire pressures may vary according to the vehicle manufacturer's specifications.

Remember to follow your vehicle Owner's Manual for tire rotation intervals. Your Limited Warranty recommends Toyo brand tires to be rotated as follows:

- Every 3,500 miles or less for high performance (low profile) tires.
- Every 7,500 miles or less for standard passenger and light truck tires.

More frequent rotation or a thorough vehicle inspection may be necessary if, upon inspection, irregular or erratic treadwear is beginning to appear.

It is important to remember the following:

- These tire rotation recommendations do not take into account different tire and construction types mixed on the vehicle.
- Some tires cannot be rotated in the manner described. Such tires include unidirectional tires. Unidirectional tread patterns must be rotated front-to-rear only so that the direction of revolution does not change.
- Some vehicles are designed with different tire sizes on the front and rear axles. Normally, such combinations will not allow rotation. Prior to rotating, consult the vehicle Owner's Manual.
- For vehicles with dual rear wheels, see the vehicle Owner's Manual for the vehicle manufacturer's procedures. If your vehicle Owner's Manual is not available, please contact the vehicle manufacturer.
- Some vehicles are equipped with wheels that limit the choice of rotation pattern. Consult the vehicle Owner's Manual.

Preferred Tire Rotation Patterns

Rear and Four Wheel Drive Vehicles

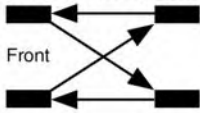

Front Wheel Drive Vehicles

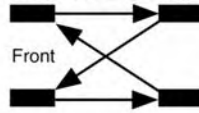

Alternate Tire Rotation Patterns

All Vehicles

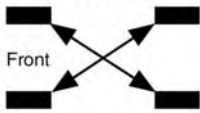

All Vehicles

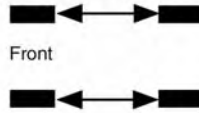

Dual Tire Rotation Patterns

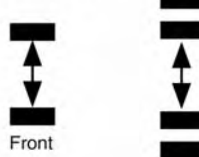
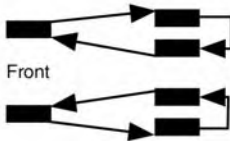

Unidirectional Tire Rotation Patterns

5-Wheel

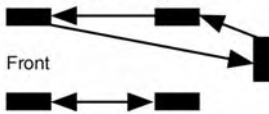

4-Wheel

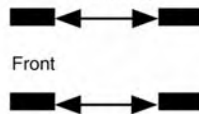

- Do not include temporary spare tires in the rotation pattern. However, if your spare tire is the same size and type as a road tire (for LT tires of the same size, type, and load rating), it should be included in the tire rotation process. The proper procedure is to use the vehicle manufacturer's recommended tire rotation procedures, or if not available, to use the appropriate rotation pattern shown, inserting the spare in the right rear position. Place the tire that would have gone to the right rear in the spare tire storage position as the new spare.

- Important! After rotation, adjust the pressure of the individual tires to the vehicle manufacturer's recommendation or the inflation pressure recommended by Toyo Tires for an optional fitment according to the tire's new location on the vehicle.
- Do not mix speed-rated tires on the same axle. Higher speed-rated tires must remain on the rear axle. Consult your authorized Toyo Tires dealer.

TIRE SPEED RATING

All Toyo Tires passenger, light truck, and truck tires have a maximum speed rating based on size and type. Tires must never be operated in excess of their rated speed limit! Consult your tire dealer or contact Toyo Tires at 1-800-442-8696 (Pacific Time) or 1-888-444-8696 (Eastern Time) if you are not sure about the maximum speed rating of your tires.

WARNING!

No tire, regardless of its design or speed rating, has an unlimited capacity for speed. Exceeding the tire's speed capability could cause overheating and sudden tire failure, possibly leading to loss of vehicle control and serious personal injury or death.

Toyo Tires does not endorse the operation of any vehicle in an unsafe or unlawful manner. Obey all local speed limits.

Tire speed ratings do not imply that a vehicle can be safely driven at the speed for which the tire is rated. Speed ratings are based on laboratory tests and relate to performance on the road, but are not applicable if tires are underinflated, overloaded, worn out, damaged, or altered.

WARNING!

High-speed driving with underinflated or overloaded tires may result in immediate tire failure, possibly leading to loss of vehicle control, which could cause an accident, including serious personal injury or death.

EXPLANATION OF TIRE SPEED SYMBOLS



Example: W=Speed Rating

A speed rating is designated by a letter that indicates the maximum speed capability of a tire. The speed rating of a tire is based on standards for reaching and sustaining a specified speed, and is determined via laboratory tests that simulate road performance at various speeds.

Tires may be marked with one of these speed symbols: M, N, P, Q, R, S, T, U, H, V, W, Y, or (Y) to identify the particular tire's speed rating. Additionally, the letter Z may appear in the size designation.

When purchasing or replacing speed-rated tires, make sure to:

- Use the ranking in the following chart to compare the speed symbols of all the tires.
- Follow the vehicle manufacturer's recommendations, if any, concerning the use of speed-rated tires.

To avoid reducing the speed capability of the vehicle, replace a speed-rated tire only with another tire having at least the same or higher speed rating. Remember, the "top speed" of the "lowest rated" tire on the car cannot be exceeded without risk of tire failure.

The letter symbols and corresponding design speeds are:

Speed-Rated Symbol	Speed Category
M	Up to 81 mph (130 km/h)
N	Up to 87 mph (140 km/h)
P	Up to 93 mph (150 km/h)
Q	Up to 99 mph (160 km/h)
R	Up to 106 mph (170 km/h)
S	Up to 112 mph (180 km/h)
T	Up to 118 mph (190 km/h)
U	Up to 124 mph (200 km/h)
H	Up to 130 mph (210 km/h)
V	Up to 149 mph (240 km/h)
W	Up to 168 mph (270 km/h)*
Y	Up to 186 mph (300 km/h)*
ZR	Over 149 mph (240 km/h)**
(Y)	Over 186 mph (300 km/h)**

* Any tire with a speed capability above 149 mph (240 km/h) can, at the tire manufacturer's option, include a "Z" in the size designation (e.g., 245/40ZR18). If the load index and the speed symbol are not included, the tire manufacturer must be consulted for the maximum speed capability (P245/40ZR18 speed capability is greater than 149 mph [240 km/h]). If a service description is included with the size description, the speed capability is limited by the speed symbol in the service description (i.e., 235/45ZR17 97W = maximum speed 168 mph [270 km/h]).

** Although no upper limit speed is specified, the indicated tires nonetheless have limited rated speed capability. Call 1-800-442-8696 (Pacific Time) or 1-888-444-8696 (Eastern Time) for a referral for more technical information.

NOTE: Tire speed symbols do not imply that vehicles can be safely driven at the maximum speed for which the tire is rated, particularly under adverse road and weather conditions, or if the vehicle has unusual characteristics. Never operate a vehicle in an unsafe or unlawful manner.

TIRE SPINNING

WARNING!

Spinning a tire to remove a vehicle stuck in mud, snow, or wet grass can be dangerous. This could cause serious personal injury or death to a bystander or passenger and extensive vehicle damage. A tire spinning at a speedometer reading above 35 miles per hour (55 km/h) can reach a speed capable of disintegrating a tire with explosive force within a matter of seconds. Under some conditions, a tire may be spinning at twice the speed shown on the speedometer. Never spin a tire above a speedometer reading of 35 mph (55 km/h). Never allow anyone to stand near or directly behind the spinning tire. Do not spin if a drive wheel is off the ground.

TOWING OR USE OF SLIDE-IN TRUCK CAMPERS

If you are towing a trailer or using a slide-in truck camper, refer to your vehicle Owner's Manual.

WINTER (SNOW) TIRES



Winter driving presents special challenges for vehicle handling. The use of winter tires, studs, and chains, while improving traction performance in snow and ice, requires additional caution and care with regard to braking, cornering, and speed. It is important to drive with care not only on snow and ice, but on dry and wet roads as well.

WARNING!

Studded tires may require longer braking distances on dry or wet paved surfaces. Failure to allow for adequate braking distance could result in serious personal injury or death.

- Traction is considerably reduced as snow tires approach 50% tread wear, and replacement should be considered in order to maintain effectiveness in heavy snow conditions.
- Tire speed rating – When lower-speed-rated winter tires replace higher-speed-rated touring and high performance all-season radial tires, do not exceed the lower-rated speed.

- Follow recommendations in the vehicle Owner’s Manual for winter tires, studs, and chains.
- Consult your tire dealer, the Rubber Manufacturers Association website www.rma.org, or your state’s Department of Transportation (DOT) for information regarding regulatory and seasonal restrictions for stud usage.
- Also see the “Tire Mixing” section in this manual for more details.
- Toyo Tires recommends that snow tires be installed in matched sets of four.

ADVERSE WEATHER DRIVING TAKE SPECIAL CARE WHEN DRIVING IN ADVERSE WEATHER CONDITIONS.

- Rain and snow – Driving in rain or snow considerably reduces the traction between your tires and the road surface. You must always reduce your speed to allow additional stopping distance between you and the vehicles ahead of you.
- Hydroplaning and wet weather driving – Hydroplaning occurs on wet roads and refers to the loss of tire contact with the road due to the build-up of water between the tire contact patch and the road surface. Three main factors affect hydroplaning and, consequently, your tire traction on wet roads:
 1. Vehicle Speed – As speed increases, wet traction is considerably reduced.
 2. Water Depth – The deeper the water, the sooner your tires will lose traction. Even thin water layers can create sufficient lubrication to cause traction loss at low speeds, depending on road conditions.
 3. Tire Tread Depth – As your tires wear down, their decreased ability to resist hydroplaning can result in a complete loss of traction and vehicle control. You should always reduce your speed with consideration for the traffic around you.
- Driving on ice and snow – Your all-season tires were designed to provide higher levels of snow traction compared to non-all- season tires. You have all-season tires if you find the letters “M&S” are molded into the sidewall near the bead. These letters mean “Mud and Snow.” Tires designed for use in severe snow conditions generally have tread patterns, structure, and materials for giving superior performance. These tires are marked with the “M&S” designation plus

TOYO TIRES – LIMITED WARRANTY

a mountain/snowflake symbol . Even the best all-season tires will not provide acceptable levels of traction if you drive too fast in snow or ice conditions and if you do not allow more stopping distance on icy roads compared to dry road surfaces. Your ability to safely maneuver your vehicle in snow or ice conditions is considerably reduced if your tires are too worn to provide adequate road grip.

SAFE USE OF TEMPORARY SPARE TIRES

WARNING!

The spare tire your car is equipped with may be of a different size and construction from the other tires on your vehicle. When using any temporary type spare tire, be sure to follow the vehicle manufacturer's instructions. Failure to observe recommended precautions could lead to erratic vehicle behavior and/or tire damage, possibly resulting in an accident and serious personal injury or death.

- The temporary spare tire is designed for temporary use only. It must not be used continuously as a standard tire. The temporary spare tire should be returned to the trunk as soon as it is convenient to have your standard tire repaired or replaced.
- The temporary spare tire should not be used for speeds exceeding 50 mph.
- Never use chains on temporary spare tires, because it could cause damage to your vehicle.
- When you replace the temporary tire, replace it only with the same type of tire.
- A full-size spare tire in your vehicle is intended for use as a spare when needed. Please see the "Tire Rotation" section for the proper procedures for including the same size construction and speed-rated tire (for LT tires of the same size, type, and load rating) in the rotation pattern. (Do not rotate a temporary spare tire.)

WARNING!

- Check inflation pressure before using your spare tire. Failure to have proper inflation pressure when using your spare tire may cause loss of vehicle control, which could result in serious personal injury or death. Maintain spare tire inflation pressures based on the vehicle Owner's Manual or the Tire Information Placard.
- "T" Type high-pressure temporary spare tires should not be used with any other wheel, nor should standard tires, snow tires, wheel covers, or trim rings be used on the high-pressure spare tire wheel. If you fail to follow this warning, your vehicle's handling characteristics can be seriously affected. You could have an accident resulting in serious personal injury or death. Consult your vehicle Owner's Manual for the proper use of your "temporary use" spare tire.
- Do not operate your vehicle with more than one temporary spare in use (this does not apply to a full size spare), and only operate it at limited speeds and distances as indicated on the sidewall of the tire.
- Driving over large obstacles and other road hazards. Check your vehicle Owner's Manual for other special clearance precautions when using the "T" Type temporary spare tire provided in your vehicle.

TIRE STORAGE

Tires should be stored indoors in a cool dry place where water cannot collect inside the tires. The tires should be placed away from harmful ozone-producing electric generators and motors and sources of heat such as hot pipes. Storage surfaces should be clean and free of grease, gasoline, or other substances, which can deteriorate the rubber.

COMPETITION TIRE STORAGE

The rubber compounds used in these tires have unique properties that, when compared to other tires, can cause them to lose some of their flexibility when used or handled in conditions below 15° F (-9° C). This loss in flexibility can lead to potential cracking and other damage to the tire. To minimize the chances of this happening, you are advised to follow these instructions:

1. Do not move or operate the car with these tires in conditions below 15° F (-9° C).

TOYO TIRES – LIMITED WARRANTY

2. Avoid moving these tires in conditions below 15° F (-9° C).
3. Before mounting and dismounting, store these tires for at least 24 hours in a temperature-controlled environment of 68° F (20° C) or warmer.
4. Remove these tires from the vehicle and deflate to half the normal air-pressure during prolonged periods of non-use or storage.

Always inspect tires for signs of cracking and never use tires that have cracked.

WARNING!

Improper storage can damage your tires in ways that may not be visible and could lead to serious personal injury or death.

SPECIAL ADVICE FOR LIGHT TRUCKS

Never exceed the speed limit as indicated by the speed symbol on the tire's sidewall. See the chart and explanation of speed ratings in this manual.

If you do not know the speed rating of your Toyo brand tire, contact your Toyo Tires dealer or Toyo Tire U.S.A. Corp. for current information.

TIRES DESIGNATED AS "LT" WITH NO SPEED RATING INDICATED ON THE SIDEWALL



The diagram shows a curved section of a tire sidewall with several parallel lines representing the tread pattern. The text "LT265/75R16" is printed on the sidewall, with "LT" in a larger, bold font and "265/75R16" in a smaller font.

It is not recommended that any light truck be operated at speeds in excess of legal limits. However, if it is anticipated that sustained driving at

speeds in excess of 65 mph may be required, then the following adjustments or recommendations should be followed:

- At speeds from 66 mph through 75 mph, cold inflation pressure must be increased 10 psi above the recommended pressures for the load being carried.
- Do not exceed the maximum inflation pressure of the wheel (all wheels have maximum allowable inflation pressures).

REPLACEMENT TIRES FOR LIGHT TRUCKS – P-METRIC VS . LT-TRUCK



Tire installers should exercise extreme caution when replacing tires on light trucks.

The maximum load capacity stamped on the sidewall of a P-metric tire is reduced by a factor of 1.1 when used on a light truck, a sport utility vehicle, or a trailer.

WARNING!

- P-metric and LT-metric tires are not necessarily interchangeable. P-metric and LT-metric tires follow completely different Load/Inflation tables and are designed to carry different loads at different pressures. LT-metric tires carry their load at higher inflation pressures and do not always have adequate load capacity to replace P-metric tires of the same size. After reducing a P-metric tire's load rating by dividing by 1.1 for fitment on a Light Truck, the P-metric tire may not offer sufficient load capacity to replace an LTmetric tire of the same size.
- Contact your Toyo Tires dealer or Toyo Tires Technical Service for help determining how to choose a proper replacement size. Driving with underinflated or overloaded tires may result in immediate tire failure, which can cause an accident and could lead to serious personal injury or death.

When a P-metric or metric tire is installed on a light truck (SUV, pickup, minivan), the load rating is reduced by dividing by 1.1. (This load reduction factor is prescribed by Federal Motor Vehicle Safety Standards (FMVSS) and is based on the expectation that passenger-type tires may experience more severe loading and usage conditions when applied to light trucks.) For example, 305/50R20 has a maximum load capacity of 3086 lbs. If this tire is fitted to a light truck, the actual allowable load for the tire is 2805 lbs. (3086 lbs. divided by 1.1).

Consult the load and inflation charts that can be found at www.toyotires.com. Contact Toyo Tires Technical Service with any tire replacement questions: 1-800-442-8696 (Pacific Time) or 1-888-444-8696 (Eastern Time).

VEHICLES WITH MODIFIED SUSPENSION

WARNING!



ROLLOVER HAZARD

Large-diameter tires and modified suspensions that increase ground clearance will alter vehicle handling.

- The vehicle may become more likely to roll over.
- Braking distances may increase.
- Slower speeds may be required to maintain control.

Drive with extreme caution until you become familiar with how your vehicle handles. Always wear your seat belt. Some modifications may be illegal in your state. Consult your Owner's Manual, the instructions for this product, and state law before modifying your vehicle.

USEFUL TIRE INFORMATION

There is a lot of useful information molded into the sidewall of a tire. It shows the name of the tire, its size, if it is tubeless or tube type, the maximum load and maximum inflation, and important safety warnings. The sidewall markings on passenger and light truck tires are slightly different.

TYPICAL PASSENGER TIRE

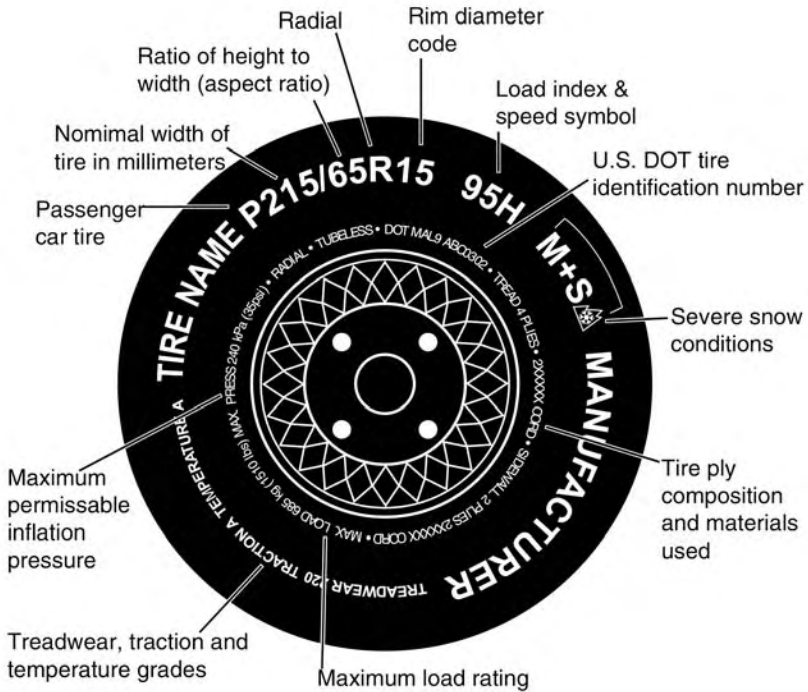

The letters “DOT” certify compliance with all applicable safety standards established by the U.S. Department of Transportation (DOT). Adjacent to this is a tire identification or serial number. This serial number is a code with up to 12 digits that are a combination of numbers and letters. The last characters are numbers identifying the week and year of manufacture. (For example, “1502” means the fifteenth week of the year 2002.)

The DOT requires tire manufacturers to grade passenger car tires based on three performance factors: Treadwear, Traction and Temperature resistance. (See the “Uniform Tire Quality Grading (UTQG)” section for more details.)

The sidewall also shows the type of cord and the number of plies in the sidewall and under the tread.

TYPICAL LIGHT TRUCK TIRE

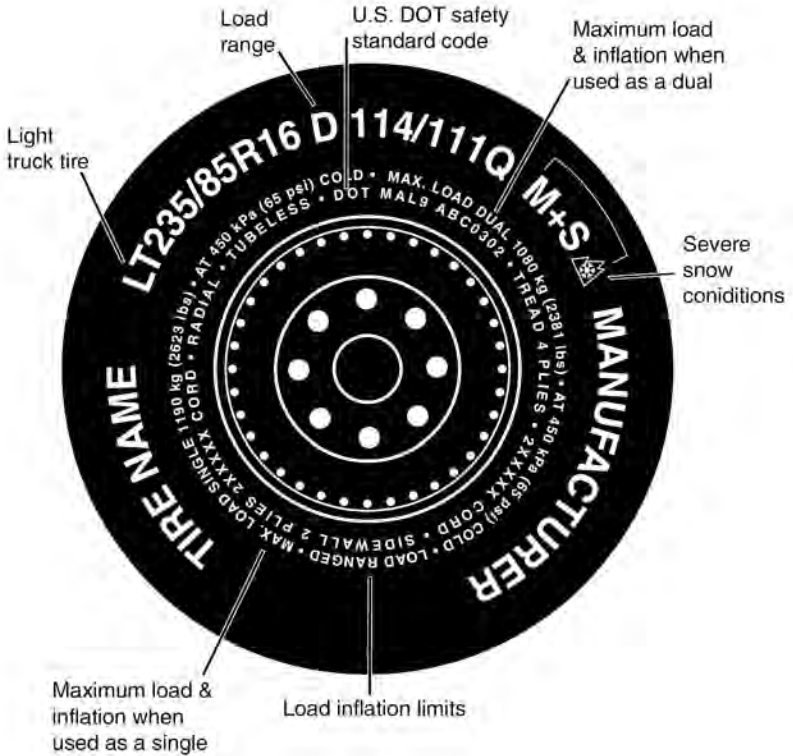

UNIFORM TIRE QUALITY GRADING (UTQG)

The Uniform Tire Quality Grading (“UTQG”) standards are intended to assist you in making an informed choice in your purchase of passenger car tires by providing information indicating relative performance in the areas of treadwear, wet stopping traction, and temperature resistance. All passenger car tires must conform to federal safety requirements in addition to these grades.

- **Treadwear** - The treadwear grade is a comparative rating based on the wear rate of the tire tested under controlled conditions on a specified government test track. For example, a tire graded 200 would wear twice as long on the government course as a tire graded 100. It is wrong to link treadwear grades with your projected tire mileage. The relative performance of the tires depends upon the actual conditions of

TOYO TIRES – LIMITED WARRANTY

their use and may vary due to driving habits, service practices, differences in road characteristics, and climate.

- Traction - The traction grades from highest to lowest are AA, A, B, and C, and they represent the tire's ability to stop on wet pavement as measured under controlled conditions on specified government test surfaces of asphalt and concrete.

NOTE: The traction grade assigned to tires is based on locked braking (straight ahead) traction tests and does not include cornering (turning) traction.

- Temperature - The temperature grades are A (the highest), B, and C, representing the tire's resistance to the generation of heat and its ability to dissipate heat when tested under controlled conditions on a specified indoor laboratory test wheel. Sustained high temperatures can cause the materials of the tire to degenerate and reduce tire life, and excessive temperature can lead to sudden tire failure. The grade C corresponds to a level of performance that all passenger car tires must meet under the Federal Motor Vehicle Safety Standard No. 139. Grades B and A represent higher levels of performance on the laboratory test wheel than the minimum required by law.

WARNING!

The temperature grade is established for a tire that is properly inflated and not overloaded. Excessive speed, underinflation, or excessive loading either separately or in combination can cause heat buildup and possible tire failure. This can cause an accident, which could lead to serious personal injury or death.

- DOT Quality Grades - All passenger car tires must conform to federal requirements in addition to these grades.

DOT SERIAL NUMBER SYSTEM

DOT SERIAL NUMBER SYSTEM

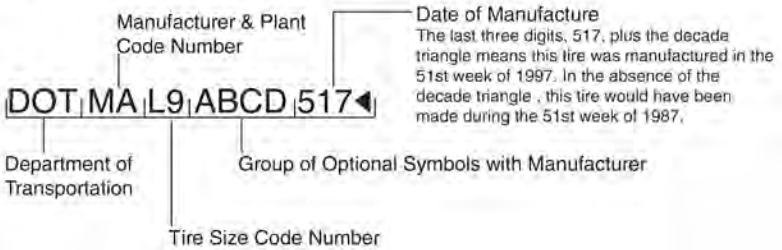

(TIRES BUILT BEFORE 2000)

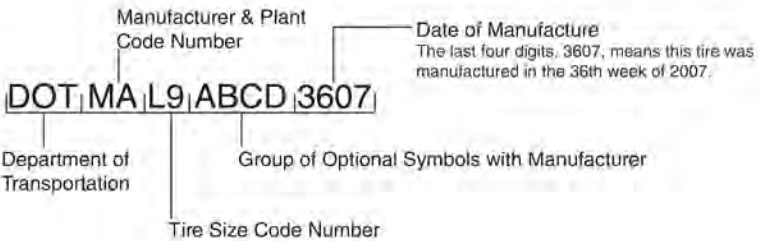

(TIRES BUILT SINCE JANUARY 1, 2000)

TIRE REGISTRATION

Your original equipment tires are registered through the vehicle manufacturer.

When you purchase replacement Toyo brand tires, the seller is required by the National Highway Traffic Safety Administration to present you with a tire registration form. Toyo Tire U.S.A. Corp. provides a registration card at no charge to all Toyo Tires dealers. The dealer must fill in the dealer name, address, and serial numbers of the tires purchased. You, the buyer, should then fill in your name and address, place a stamp on the form, and mail it to the pre-addressed location on the form. Be sure to have your dealer complete their portion of the registration card included in this Limited Warranty at the time of purchase. The information

TOYO TIRES – LIMITED WARRANTY

contained in the registration card is an important means to notify you in the event of a product recall.

If you prefer, you may register your tires on our web page at www.toyotires.com and select “Tire Registration.” Be prepared to provide the name and address of the dealer, the quantity of tires, and the DOT serial numbers from the sidewall of the tires.

IMPORTANT! If self-registering tires, make sure to include all letters and numbers (up to 12 digits) following the letters “DOT” on the tire’s sidewall near the bead. If you see only four letters next to

FOR SERVICE ASSISTANCE OR INFORMATION

For service assistance or information, contact your nearest Toyo Tires dealer.

If you need assistance, please contact your authorized Toyo Tires retailer. To locate an authorized Toyo Tires dealer, use our dealer locator at www.toyotires.com, or contact Toyo Tires Consumer Relations at:

TOYO TIRE U.S.A. CORP.

P.O. Box 6052

Cypress, California 90630-5249

1-800-442-8696

(6:30am to 5:00pm Pacific Time)

FOR SERVICE ASSISTANCE OR INFORMATION

- Contact your nearest Toyo Tire Dealer
- If you need assistance locating a Toyo Tire dealer, please contact our Consumer Relations Department toll free at 1-800-442-8696 www.toyotires.com

We can be reached in writing at:

Toyo Tire U.S.A. Corp.

P.O. Box 6052

Cypress, CA 90630-5249 11/11 400k TMS #0040401910

YOKOHAMA TIRES — LIMITED WARRANTY

LIMITED WARRANTY FOR ORIGINAL EQUIPMENT TIRES

Passenger Car Light Truck Temporary Spare

YOKOHAMA LIMITED WARRANTY

Original Equipment Tires for passenger car, temporary spare and light truck tires

As you know, many safety, comfort and performance features went into the design of your new vehicle – and your tires. At Yokohama, every tire we engineer incorporates the highest safety and comfort features in conjunction with the most enhanced performance capabilities. And, to ensure your complete satisfaction, Yokohama has enclosed this Limited Warranty brochure for your tires. As the original equipment tire manufacturer for your vehicle, Yokohama wants to offer its support in helping you properly maintain and service your tires and ensure you have the correct contact information in the unlikely event of a tire issue. Please refer to the back panel of this brochure for information on obtaining customer assistance in your area.

This limited warranty provides for tire replacement under certain specified conditions. This policy applies to original equipment tires used in normal highway service displaying warrantable conditions. Tires that become unserviceable or wear out because of neglect or mistreatment are excluded from Yokohama warranty coverage.

1. WARRANTY ELIGIBILITY

This warranty applies to every YOKOHAMA original equipment passenger car, light truck, and temporary spare tire bearing the YOKOHAMA brand name and complete DOT serial identification number. Eligible tires must be used on the vehicle on which they were originally equipped in conformance with the vehicle manufacturer's recommendations.

2. WHAT IS NOT WARRANTED

Tires that have become unserviceable for the following reasons:

- Road hazard injuries or damages, caused to the tire by obstacles and debris such as cuts, punctures (whether repairable or not), snags, bruises, tears, or impact breaks.
- Improper repairs or repairs that have failed.
- Improper inflation or other maintenance abuses.
- Incorrect mounting of the tire, or tire/wheel imbalance.
- Mechanical irregularities in the vehicle such as wheel misalignment, worn, or faulty parts.
- Accident, corrosion, vandalism, fire, or damage caused by nature.
- Tires used on vehicles in racing or special applications.
- Non-speed-rated temporary spare tires used over 50 mph (80 km/h).
- Tires worn out [2/32 inch (1.6 mm) or less of tread remaining] .
- Tires that have been retreaded.
- Tires transferred from the vehicle on which they were originally installed.
- Improper storage

3. WHAT IS WARRANTED

Tires that have become unserviceable for reasons other than stated above will be replaced in accordance with this warranty.

If a warrantable condition is found, tires will be replaced as follows:

A) Passenger Car and Light Truck Tires (Other than Temporary Spare Tires)

When a tire becomes unserviceable during the first 2/32 inch (1.6 mm) of original usable tread depth or 12 months from date of vehicle purchase, whichever comes first, it will be replaced with a comparable new YOKOHAMA tire free of charge. During this period, tires will be mounted and balanced without charge. Other service charges such as tire rotation, alignment or applicable taxes are payable by the customer.

When a tire has worn past the above specified period for free replacement, the customer must pay for the cost of a new comparable YOKOHAMA passenger car or light truck tire on a pro-rated basis. The dealer shall determine this cost by multiplying the percentage of usable tread worn by the current retail selling price of that tire at the time of warranty replacement. The costs of mounting, balancing and any other service charges or applicable taxes are payable by the customer.

The tire is covered by this warranty for the life of the original usable tread (the original tread depth down to the level of tread wear indicator bars molded at 2/32 inch or 1.6 mm) or for 48 months from the date of vehicle purchase, whichever comes first. This time period does not represent the expected service life for tires covered by this warranty.

B) Temporary Spare Tires

When the original tread of a YOKOHAMA Temporary Spare tire used in temporary highway service on the vehicle in which it was originally equipped, is worn not more than 1/32 inch or 0.8 mm, the tire will be replaced with a new YOKOHAMA Temporary Spare tire free of charge, without charge for mounting and balancing the new tire. Additional service charges are payable by the customer.

Temporary Spare tires worn in excess of 1/32 inch or 0.8 mm but less than 2/32 inch or 1.6 mm, will be replaced and the customer charged 50% of the current retail selling price of the tire. The costs of mounting, balancing and any other service charges are payable by the customer.

3. LIMITATIONS AND EXCLUSIONS

All implied warranties, including any warranty of merchantability or fitness for a particular purpose, are expressly limited to the duration of this written warranty.

All obligations or liabilities for loss of time, inconvenience, loss of vehicle use or any other incidental or consequential damages are hereby excluded. Some states do not allow limitations on how long an implied warranty lasts, or the exclusion or limitation of incidental or consequential damages so the above limitations or exclusions may not apply.

4. YOKOHAMA'S OBLIGATIONS

Replacements qualifying under the warranty will be made by an authorized YOKOHAMA retail tire dealer and will be handled quickly. Listings for participating dealers may be found in the yellow pages of your

YOKOHAMA TIRES — LIMITED WARRANTY

telephone book or at www.yokohamatire.com for US dealers and www.yokohamatire.ca for Canadian dealers.

5. CUSTOMER'S OBLIGATIONS

The customer must present the claim tire, together with the vehicle on which it was used, to an authorized YOKOHAMA retail tire dealer. Tires replaced on a warranty basis become the property of YOKOHAMA TIRE CORPORATION.

The customer is required to pay the adjusted price of the new tire (dealer's current retail selling price at the time of adjustment less credit allowance) and taxes. The customer is responsible for any payments arising out of dealer service such as mounting, balancing, tire rotation, and alignment UNLESS SPECIALLY INCLUDED IN THE APPLICABLE WARRANTY.

To obtain a free-replacement warranty, the customer must present proof of vehicle purchase date either by the new vehicle invoice or license registration.

6. LEGAL RIGHTS

This warranty gives you specific legal rights. You may also have other rights which may vary from state to state.

YOKOHAMA TEMPORARY SPARE TIRE

High Pressure Spare Operating Instructions

Any tire, no matter how well constructed, may fail due to improper maintenance or service factors. Tire failure may create a risk of property damage and serious or fatal injury. For your safety, please follow the instructions below.

1. The YOKOHAMA high pressure spare tire is designed for temporary use only and must not be used continually as a regular tire.
2. Avoid driving over obstacles that may damage the tire through impact or cutting, such as potholes, glass, metal, etc.
3. Speed must not exceed 50 mph (80 km/h) for non-speed-rated Temporary Spare tires.

4. A tread life of up to 3,000 miles (4,800 km) can be expected depending on road conditions and your driving habits. To conserve tire tread life, the spare should be returned to the trunk as soon as the standard tire can be repaired or replaced.
5. Because the YOKOHAMA high pressure spare tire was specifically designed for your car, it should not be used on any other vehicle.
6. Do not use snow chains on your YOKOHAMA high pressure spare. This could cause damage to your vehicle.
7. When the tread wear indicator appears on the tire, replace it only with the same type spare tire.
8. Check the tire's cold inflation pressure monthly and maintain at 60 psi (4.2 kg/cm²) even when not in use. Do not inflate over 60 psi.
9. The YOKOHAMA high pressure spare tire should not be used with any other rim nor should standard tires, wheel covers, or trim rings be used on the YOKOHAMA high pressure spare tire rim on which the YOKOHAMA high pressure spare tire was originally installed.

IMPORTANT SAFETY INFORMATION

All tires require owner maintenance regardless of how well a tire is constructed. Operational damages such as punctures, impact damage, cuts, incorrect inflation, etc., may cause tire failure and subsequent personal injury and/or property damage. Simple operational and maintenance practices, as listed below, will reduce the chances of tire problems.

Tire Inspection

Visually inspect your tires frequently for any tire damage such as scrapes, bulges, cuts, nails, irregular wear, etc. resulting from operation. This must be done immediately after any known or suspected contact with an object in the road, a pothole, road irregularity or after severe braking. Refer these conditions to a reputable tire service center for repair or replacement. Never drive on a tire if such conditions appear.

Tire Loading

Never exceed the maximum vehicle load limit listed on the vehicle placard, tire information label or in the owners manual. Be aware of the load carrying limits molded into the tire's sidewall and do not exceed those limits. Maximum load can only be carried at the maximum cold inflation pressure indicated on the tire's sidewall.

Speed Limits

Regardless of the speed capability of your tires, never exceed lawful speeds or speeds dictated by driving conditions.

Hazards

Objects in the road that could damage your tires should be safely avoided. These objects include: potholes, glass, metal, rocks, wood debris and the like. Unavoidable contact should prompt a thorough tire inspection.

Air Pressure

Air pressure maintenance is critical to tire service life. Tire pressures must be checked frequently when tires are cold (before operation, cool to the touch) and no less than once per month and before extended operation. Use a tire gauge to check pressure and maintain it per the vehicle manufacturer's recommendations (on vehicle placard or in owner's manual). Do not reduce pressure when tire is hot and do not inflate a cold tire higher than limits molded on the tire's sidewall. Do not overlook spare tire inflation pressure.

Tire Tread

Tires must be replaced when the depth of the tread reaches 2/32 inch (1.6 mm). YOKOHAMA tires are manufactured with tread wear indicators molded into the tire grooves which indicate tread wearout. As tires wear down to 2/32 inch (1.6 mm), and tread depth is reduced, tire traction is reduced during rainfall and winter road conditions. Visual tire inspection therefore becomes more crucial as the tires wear out.

Hard Braking

You must inspect your tires after any hard braking situations or after tires have slid on the pavement. This can cause a flat spot or other damage to the tread of the tire.

Spinning

- Do not allow tires to spin at speeds greater than 35 mph if vehicle becomes stuck.
- Do not stand behind a spinning tire while attempting to push a vehicle. Speed and force can cause a tire to disintegrate and explode and may cause property damage and/or personal injury.

U.S.A.

For Customer Assistance call:

1-800-722-9888

(available Monday-Friday, 6:00 AM – 4:00 PM PST)

Select #1 for the Yokohama Dealer Locator

(available 24 hours a day, 7 days a week)

Yokohama Tire Corporation

Corporate Headquarters
1 MacArthur Place, Suite 800
Santa Ana, California 92707
1-800-423-4544

We want your feedback.
We invite you to complete
our customer satisfaction survey on
www.yokohamatire.com

CANADA

Yokohama Tire (Canada) Inc.

Corporate Headquarters
#500 – 9325 200th Street
Langley, B.C. V1M 3A7

For Canadian Customer Assistance call:

1-888-965-6835

The Yokohama Rubber Co., LTD.

36-11, Shimbashi 5-Chome
Minato-ku, Tokyo 105-8685, Japan

NOTES



18TIRE-026-AB